

**Alspa CE80–20 N80
Bus Interface Unit
User's Manual**

ALS 52307 c-en

First issue: 04–1995
This edition: 05–2000

Meaning of terms that may be used in this document / Notice to readers

WARNING

Warning notices are used to emphasize that hazardous voltages, currents, temperatures, or other conditions that could cause personal injury exist or may be associated with use of a particular equipment.

In situations where inattention could cause either personal injury or damage to equipment, a Warning notice is used.

Caution

Caution notices are used where there is a risk of damage to equipment for example.

Note

Notes merely call attention to information that is especially significant to understanding and operating the equipment.

This document is based on information available at the time of its publication. While efforts have been made to be accurate, the information contained herein does not purport to cover all details or variations in hardware or software, nor to provide for every possible contingency in connection with installation, operation, or maintenance. Features may be described herein which are not present in all systems. ALSTOM assumes no obligation of notice to holders of this document with respect to changes subsequently made.

ALSTOM makes no representation or warranty, expressed, implied, or statutory with respect to, and assumes no responsibility for the accuracy, completeness, sufficiency, or usefulness of the information contained herein. ALSTOM gives no warranties of merchantability or fitness for purpose shall apply.

In this publication, no mention is made of rights with respect to trademarks or tradenames that may attach to certain words or signs. The absence of such mention, however, in no way implies there is no protection.

Partial reproduction of this document is authorized, but limited to internal use, for information only and for no commercial purpose.

However, such authorization is granted only on the express condition that any partial copy of the document bears a mention of its property, including the copyright statement.

All rights reserved.

© Copyright 2000. ALSTOM (Paris, France)

Index letter	Date	Nature of revision
b	06-1998	Adding: <ul style="list-style-type: none">• Micro Field Processor.• Appendix C: characteristics of bus cable.• Appendix D: configuration examples.
c	05-2000	Adding: <ul style="list-style-type: none">• IC670ALG881/882.• IC670MMD441.• Subsection 1.9, Chapter 2 – Hot Insertion.

Revisions

This manual describes the Alspa CE80–20 – N80 Bus Interface Unit (CE670GBI002). It explains operation of the Bus Interface Unit as an Alspa N80 network device. It also contains complete configuration instructions for the Bus Interface Unit and all CE80–20 I/O modules.

1. CONTENT OF THIS MANUAL

Chapter 1. Introduction: Chapter 1 introduces CE80–20 systems, the N80 Bus Interface Unit and other equipment that may be used with the Bus Interface Unit. It will help you locate more information about the components and operation of CE80–20 products.

Chapter 2. Description: Chapter 2 describes the N80 Bus Interface Unit module, the Bus Interface Unit Power Supply and the Bus Interface Unit Terminal Block, and lists their specifications.

Chapter 3. Installation: Chapter 3 describes Bus Interface Unit installation and gives system installation guidelines.

Chapter 4. Operation: Chapter 4 explains how a Bus Interface Unit interacts with the modules in its station, how it stores data and how it exchanges data with a PLC or other type of system host.

Chapter 5. Station Configuration: Chapter 5 explains how to configure a Bus Interface Unit and the I/O modules in a station using a Hand-Held Monitor.

Chapter 6. Diagnostics and Fault Clearing: Chapter 6 describes the diagnostics capabilities of the Bus Interface Unit and explains how faults can be cleared from a Hand-held Monitor or programmer.

Chapter 7. Monitoring and Controlling CE80–20 Data: Chapter 7 explains how to monitor or control CE80–20 I/O data using a Hand-held Monitor or a programmer.

Chapter 8. Datagrams: Chapter 8 lists datagrams that can be sent to a Bus Interface Unit and shows the datagram formats for CE80–20 modules that are different from those for other devices. Chapter 8 also shows the format of configuration data for the Bus Interface Unit and the modules in the station.

Appendix A. Scaling Analog Channels: Appendix A explains how to select scaling values when configuring an analog input or output. (Configuration instructions are in chapter 5).

Appendix B. Installing Additional Suppression: Appendix B describes some precautions that can be taken in an installation to help assure proper operation.

Appendix C. The Alspa N80 Serial Bus. This appendix describes the selection and operating characteristics of the bus cable that links Alspa N80 devices.

Appendix D. Configuration Examples. This appendix includes examples of different Alspa CE80–20 Station configurations.

Preface

2. RELATED PUBLICATIONS

For more information, refer to these publications:

ALS 52301 Alspa CE80–15 I/O System and Alspa N80 Communications Network User's Manual. Reference manual for system designers, programmers, and others involved in integrating I/O products in a PLC or host computer environment. This book provides a system overview, and describes some the types of systems that can be created with an Alspa N80 network. Datagrams, Global Data and data formats are defined.

ALS 52308 Alspa CE80–20 I/O Modules User's Manual. This book describes CE80–20 I/O Modules and I/O Terminal Blocks and explains how to install them.

ALS 52314 Alspa CE80–20 Micro Field Processor User's Manual. This book describes the Alspa CE80–20 Micro Field Processor and I/O terminal blocks and explains how to install them.

ALS 52511 Alspa C80–35 PLC Bus Controller for Alspa N80 Network (NBC) User's Manual. Reference manual for the Bus Controller, which interfaces an Alspa N80 bus to an Alspa C80–35 PLC. This book describes the installation and operation of the Bus Controller. It also contains the programming information needed to interface I/O devices to an Alspa C80–35 PLC.

ALS 52507 Personal Computer Interface Module (PCIM) for Alspa N80 Network User's Manual. Reference manual for the PCIM, which interfaces a N80 bus to a suitable host computer. This book describes the installation and operation of the PCIM. It also contains the programming information needed to interface CE80–15 I/O devices to a host computer.

ALS 52612 Installation Requirements for Conformance to Standards

3. MANUAL NUMBERS

In some cases, Alspa 8000 manuals may be issued with numbers that differ from the one given under "Related Publications" in the Preface of other manuals, or in Important Product Information or data sheets.

The contents are similar.

The table below shows the correspondence between "ALS" and equivalent numbers for the manuals concerned:

<i>ALS Number</i>	<i>Other Number</i>	<i>ALS Number</i>	<i>Other Number</i>
<i>ALS 52113</i>	<i>GFK-0600</i>	<i>ALS 52503</i>	<i>GFK-0585</i>
<i>ALS 52126</i>	<i>GEK-1527</i>	<i>ALS 52507</i>	<i>GFK-0074</i>
<i>ALS 52302</i>	<i>GEK-90486-2</i>	<i>ALS 52508</i>	<i>GFK-0868</i>
<i>ALS 52303</i>	<i>GFZ-0043</i>	<i>ALS 52514</i>	<i>GFK-0870</i>
<i>ALS 52314</i>	<i>GEK-1171</i>	<i>ALS 52515</i>	<i>GFK-1026</i>
<i>ALS 52404</i>	<i>GFK-0415</i>	<i>ALS 52523</i>	<i>GFK-1063</i>
<i>ALS 52405</i>	<i>GFK-0819</i>	<i>ALS 52603</i>	<i>GFK-0450</i>

4. WE WELCOME YOUR COMMENTS AND SUGGESTIONS

ALSTOM strives to produce quality technical documentation. Please take the time to fill in and return the "Reader's Comments" page if you have any remarks or suggestions

ALS 52307 c-en Alspa CE80-20 N80 Bus Interface Unit User's Manual

Your main job is:

- | | |
|--|--|
| <input type="checkbox"/> System designer | <input type="checkbox"/> Programmer |
| <input type="checkbox"/> Distributor | <input type="checkbox"/> Maintenance |
| <input type="checkbox"/> System integrator | <input type="checkbox"/> Operator |
| <input type="checkbox"/> Installer | <input type="checkbox"/> Other (specify below) |

If you would like a personal reply, please fill in your name and address below:

COMPANY: NAME:
ADDRESS:
..... COUNTRY:

Send this form directly to your ALSTOM sales representative or to this address:

**ALSTOM Technology
Technical Documentation Department (TDD)
5 avenue Newton BP 215
92142 Clamart Cedex
France
Fax: +33 (0)1 46 29 12 44**

All comments will be considered by qualified personnel.

REMARKS

Continue on back if necessary.

Reader's comments

CHAPTER 1 – INTRODUCTION

1.	OVERVIEW OF ALSPA CE80–20	1–1
1.1.	Description	1–1
1.2.	Features	1–2
2.	ALSPA CE80–20 MODULES	1–3
2.1.	N80 Bus Interface Unit	1–4
2.2.	Bus Interface Unit Terminal Block	1–4
2.3.	I/O Modules	1–4
2.4.	Micro Field Processor	1–4
2.5.	I/O Terminal Blocks and Auxiliary I/O Terminal Blocks	1–5
3.	ENVIRONMENTAL SPECIFICATIONS	1–6
4.	CONFIGURATION FOR ALSPA CE80–20	1–7
5.	ALSPA CE80–20 IN AN ALSPA N80 NETWORK	1–8
5.1.	The Host CPU	1–8
5.2.	A More Complex Alspa CE80–20 and N80 System	1–9
6.	REQUIRED HOST SYSTEM EQUIPMENT	1–10
7.	USING ALSPA CE80–20 IN A CPU REDUNDANCY SYSTEM	1–11
7.1.	CPU/Bus Controller Redundancy: Overview	1–11
7.2.	Hot Standby CPU Redundancy	1–11
7.3.	Duplex CPU Redundancy	1–11
8.	USING ALSPA CE80–20 IN AN N80 REDUNDANCY SYSTEM	1–12
8.1.	N80 Bus Redundancy: Overview	1–12
8.2.	Redundant Bus Configurations	1–12

CHAPTER 2 – DESCRIPTION

1.	N80 BUS INTERFACE UNIT	2–1
1.1.	LEDs	2–2
1.2.	Bus Interface Unit Power Supply	2–3
1.3.	Timing	2–3
1.4.	Backplane Current	2–4
1.5.	Calculating Input Power Requirements for a Bus Interface Unit	2–4
1.6.	Bus Interface Unit Power Dissipation	2–5
1.7.	Load Requirements for Hardware Components	2–6
1.8.	Hand-Held Monitor and Hand-Held Programmer	2–6
1.9.	Hot Insertion/Removal of Modules	2–7
1.9.1.	Faults Reported During Hot Insertion/Removal	2–7

Contents

1.9.2.	I/O Module Data During Hot Insertion/Removal	2-7
1.9.3.	Hot Insertion/Removal for a Micro Field Processor	2-7
1.9.4.	Hot Insertion/Removal Not Permitted in Hazardous Locations	2-7
2.	BUS INTERFACE UNIT TERMINAL BLOCK	2-8
3.	FUNCTIONAL SPECIFICATIONS	2-9
 CHAPTER 3 – INSTALLATION		
1.	PREINSTALLATION CHECK	3-2
2.	STATIC PROTECTION	3-2
3.	HAND-HELD MONITOR CONNECTOR	3-2
4.	SYSTEM WIRING GUIDELINES	3-3
4.1.	Types of Wiring	3-3
4.2.	Installing Additional Suppression	3-3
5.	SYSTEM GROUNDING	3-4
6.	LOCATIONS FOR ALSPA CE80-20	3-5
7.	INSTALLING THE DIN RAIL	3-6
8.	INSTALLING THE BUS INTERFACE UNIT TERMINAL BLOCK ON THE DIN RAIL	3-8
8.1.	Installation	3-8
8.2.	Removal	3-9
9.	INSTALLING THE CABLES BETWEEN TERMINAL BLOCKS	3-10
10.	POWER WIRING TO THE BUS INTERFACE UNIT	3-11
11.	CONNECTING THE COMMUNICATIONS BUS	3-12
11.1.	Bus Cables	3-13
11.2.	Making Bus Connections	3-13
11.3.	Terminating a Bus	3-14
11.3.1.	Using Prefabricated Terminating Resistors	3-14
11.3.2.	Installing Pre-Moulded Bus Cables	3-15
11.3.3.	Bus Connection for Critical Processes	3-17
12.	INSTALLING THE BUS INTERFACE UNIT ON THE TERMINAL BLOCK	3-18
13.	REMOVING THE BUS INTERFACE UNIT FROM THE TERMINAL BLOCK	3-19

14.	REMOVING/REPLACING THE BUS INTERFACE UNIT FUSE	3-20
15.	UPGRADING THE BIU FIRMWARE	3-21

CHAPTER 4 – OPERATION

1.	BIU DATA HANDLING AT THE I/O STATION	4-2
1.1.	I/O Data for Conventional Modules	4-3
1.2.	I/O Data, Status Data and Control Data for Intelligent Modules	4-3
1.3.	Group Data for Intelligent Modules	4-4
2.	THE BIU SWEEP	4-6
2.1.	BIU Reads Inputs from Conventional Modules	4-6
2.2.	BIU Reads All Input Reference Parameters	4-6
2.3.	BIU Reads Group Data Whose Destination is BIU	4-7
2.4.	BIU Sends Group Data to Synchronization Module	4-7
2.5.	BIU Sends Reference Parameters to a Synchronization Module	4-7
2.6.	Move Input Data to the Communications Buffer	4-7
2.7.	Move Output Data from the Communications Buffer	4-7
2.8.	Move Reference Parameters from a Synchronization Module to the BIU	4-7
2.9.	Move Group Data from Synchronization Module to BIU	4-8
2.10.	Send Outputs to Conventional Modules	4-8
2.11.	Send Reference Parameters to Intelligent Modules	4-8
2.12.	Move Group Data to Intelligent Modules	4-8
2.13.	Background Tasks	4-8
3.	BIU BACKPLANE SCAN TIME	4-9
4.	DATA TRANSFER BETWEEN THE BIU AND THE HOST	4-11
4.1.	Data in the BIU's Network (Bus) Map	4-11
4.2.	Communications on the N80 Bus	4-11
4.3.	Input Data Sent by the Bus Interface Unit	4-12
4.3.1.	Input Defaults	4-12
4.3.2.	I/O Data Handling by Host	4-12
4.4.	Outputs from the Host to the BIU	4-13
4.4.1.	Output Data Format	4-13
4.4.2.	Output Defaults	4-13
5.	N80 BUS SCAN TIME	4-14
5.1.	Procedure for Estimating Bus Scan Time for an Alspa CE80-20 Station	4-14
5.2.	Throughput	4-15
6.	OPERATION OF THE BIU WITH A MICRO FIELD PROCESSOR	4-16
6.1.	MFP and BIU Synchronization	4-16
6.2.	MFP I/O References	4-16
6.3.	MFP Operating Modes	4-17

Contents

6.4.	Overview of Synchronous Operation	4-19
7.	BACKING UP MICRO FIELD PROCESSOR OUTPUTS	4-20
8.	HOW THE NETWORK BACKS UP MFP OUTPUTS	4-21
9.	BACKING UP BIU OUTPUTS WITH A MICRO FIELD PROCESSOR	4-22

CHAPTER 5 – STATION CONFIGURATION

1.	CONFIGURE THE SERIAL BUS ADDRESS AND BAUD RATE	5-3
2.	SET UP THE HAND-HELD MONITOR	5-4
3.	CREATE A NEW CONFIGURATION	5-5
4.	CONFIGURE THE BUS INTERFACE UNIT	5-6
4.1.	Change the Serial Bus Address of the Bus Interface Unit	5-8
4.2.	Select the Baud Rate	5-9
4.3.	Configure Fault Reporting	5-10
4.4.	Configure N80 Network Redundancy	5-10
4.5.	Configure CPU Redundancy	5-11
4.6.	Select Configuration Protection	5-13
4.6.1.	Tag Name Screen	5-13
4.6.2.	Review or continue configuration	5-13
5.	CONFIGURE ALSPA CE80-20 MODULES	5-14
5.1.	Enable/Disable the I/O Scan	5-14
5.2.	Disable Network I/O Updates	5-14
6.	CONFIGURE THE NETWORK MAP FOR THE BUS INTERFACE UNIT	5-15
6.1.	Configuring Extra References in the BIU I/O Map	5-16
6.2.	Example	5-16
7.	ADD MODULES AND ASSIGN REFERENCES	5-19
7.1.	Configuration with No Module Present	5-20
7.2.	Read a Module Identification with the Module Present	5-20
7.3.	Delete an Existing Module Configuration	5-20
8.	CONFIGURE A DISCRETE INPUT MODULE	5-21
8.1.	Assign I/O References for the Module	5-21
8.2.	Module Fault Reporting	5-22
8.3.	Default Inputs or Hold Last State	5-23
9.	CONFIGURE A DISCRETE OUTPUT MODULE	5-24

9.1.	Assign I/O References for the Module	5-24
9.2.	Default Outputs or Hold Last State	5-25
9.3.	Module Fault Reporting	5-26
10.	CONFIGURE A DISCRETE INPUT/OUTPUT MODULE	5-27
10.1.	Assign I/O References	5-27
10.2.	Module Fault Reporting	5-28
10.3.	Default Inputs or Hold Last State	5-28
10.4.	Default Outputs or Hold Last State	5-29
11.	CONFIGURE A CONVENTIONAL ANALOG INPUT MODULE	5-30
11.1.	Assign I/O References for the Module	5-30
11.2.	Channel Fault Reporting	5-31
11.3.	Channel Active	5-31
11.4.	Input Current Ranges	5-32
11.5.	Input Scaling	5-33
11.6.	Alarm limits	5-34
11.7.	Default Inputs or Hold Last State	5-35
12.	CONFIGURE A CONVENTIONAL ANALOG OUTPUT MODULE	5-36
12.1.	Assign I/O References for the Module	5-36
12.2.	Default Outputs or Hold Last State	5-37
12.3.	Output Default Values	5-37
12.4.	Channel Fault Reporting	5-38
12.5.	Channel Active	5-38
12.6.	Output Current Ranges	5-39
12.7.	Output Scaling	5-40
13.	CONFIGURE A 16-POINT GROUPED ANALOG INPUT MODULE	5-41
13.1.	Assign I/O References for the Module	5-41
13.2.	Configure Data Defaults	5-43
13.3.	Configure Filtering	5-44
13.4.	Configure the Line Frequency	5-44
13.5.	Circuit Configuration	5-45
13.5.1.	Channel Header	5-45
13.5.2.	Channel Active	5-45
13.5.3.	Input Range	5-46
13.5.4.	Input Scaling	5-47
13.5.5.	Alarm Limits	5-48
14.	CONFIGURE AN 8-POINT GROUPED ANALOG VOLTAGE INPUT MODULE ...	5-49
14.1.	Assign I/O References for the Module	5-49
14.1.1.	Configure Data Defaults	5-51
14.1.2.	Configure Filtering	5-52
14.1.3.	Configure the Line Frequency	5-53
14.2.	Circuit Configuration	5-53
14.2.1.	Channel Header	5-53
14.2.2.	Channel Active	5-54
14.2.3.	Input Range	5-54

Contents

14.2.4.	Input Scaling	5-55
14.2.5.	Alarm Limits	5-56
15.	CONFIGURE A 16-POINT GROUPED ANALOG VOLTAGE INPUT MODULE	5-58
15.1.	Assign I/O References for the Module	5-58
15.2.	Configure Data Defaults	5-60
15.3.	Configure Filtering	5-61
15.4.	Configure the Line Frequency	5-61
15.5.	Circuit Configuration	5-62
15.5.1.	Channel Header	5-62
15.5.2.	Channel Active	5-62
15.5.3.	Input Range	5-63
15.5.4.	Input Scaling	5-63
15.5.5.	Alarm Limits	5-65
16.	CONFIGURE AN RTD INPUT MODULE	5-66
16.1.	Assign I/O References for the Module	5-66
16.2.	Assign Data Defaults	5-68
16.3.	Line Frequency	5-69
16.4.	Circuit Configuration	5-69
16.4.1.	Channel Header	5-69
16.4.2.	Channel Active	5-70
16.4.3.	Units	5-70
16.4.4.	Units' Ranges	5-71
16.5.	RTD Type	5-71
16.6.	Wire Type	5-72
16.7.	Low Alarm Limit	5-72
16.8.	High Alarm Limit	5-73
16.9.	Resistance	5-73
17.	CONFIGURE A THERMOCOUPLE INPUT MODULE	5-75
17.1.	Assign I/O References for the Module	5-75
17.2.	Assign Data Defaults	5-77
17.3.	Line Frequency	5-78
17.4.	Suppress Open Thermocouple Diagnostic	5-78
17.5.	Circuit Configuration	5-78
17.5.1.	Channel Active	5-78
17.5.2.	Engineering Units	5-79
17.5.3.	Thermocouple Type	5-79
17.5.4.	Range Type	5-80
17.5.5.	Low Alarm Limit	5-80
17.5.6.	High Alarm Limit	5-81
17.5.7.	Reference Junction Compensation	5-81
17.5.8.	Reference Junction Value	5-81
17.5.9.	Offset	5-82
17.5.10.	Configure the Next Channel	5-82
18.	CONFIGURE AN 8-POINT ANALOG VOLTAGE OUTPUT MODULE	5-83
18.1.	Assign I/O References for the Module	5-83
18.1.1.	Configure Data Defaults	5-86
18.1.2.	Configure Local Default Outputs	5-87
18.2.	Circuit Configuration	5-88

18.2.1.	Channel Header	5-88
18.2.2.	Channel Active	5-88
18.2.3.	Scaling Range	5-89
18.2.3.1.	Custom Scaling	5-90
19.	CONFIGURE AN 8-POINT ANALOG CURRENT OUTPUT MODULE	5-92
19.1.	Assign I/O References for the Module	5-92
19.1.1.	Configure Data Defaults	5-94
19.1.2.	Configure Local Default Outputs	5-95
19.2.	Circuit Configuration	5-96
19.2.1.	Channel Header	5-96
19.2.2.	Channel Active	5-97
19.2.3.	Scaling Range	5-97
19.2.4.	Output Scaling	5-98
19.3.	Custom Scaling	5-98
20.	CONFIGURE A MICRO FIELD PROCESSOR	5-101
20.1.	Configure the Reference Parameters for the Micro Field Processor	5-101
20.2.	Select Data Types for Micro Field Processor Data	5-102
20.3.	Assign Data Defaults	5-103
20.4.	Configure Group Data Moves	5-104
20.4.1.	Set Up a Group Data Move	5-105
20.4.2.	Identify the Source and Destination Device	5-105
20.4.3.	Configure the First Move for a Group	5-107
20.4.4.	Configure More Moves for a Group	5-107
20.4.5.	Configure the Defaults for Each Move in a Group	5-108
20.4.6.	Specify the BIU Scanning Frequency for the Data Group	5-108
20.4.7.	Return to the Group Screen	5-109
20.4.8.	Deleting a Group Data Move	5-109

CHAPTER 6 – DIAGNOSTICS AND FAULT CLEARING

1.	DIAGNOSTICS AND FAULT CLEARING FOR INTELLIGENT MODULES	6-1
2.	DIAGNOSTICS AND FAULT CLEARING FOR THE BIU AND CONVENTIONAL MODULES	6-1
3.	DISPLAY AND CLEAR FAULTS FROM A HAND-HELD MONITOR	6-3
3.1.	Displaying Faults	6-3
3.2.	Clearing Faults	6-4
4.	DISPLAY AND CLEAR FAULTS FROM AN ALSPA 8000 PLC	6-5
4.1.	Alspa C80-75 PLC I/O Fault Table	6-5
4.2.	Alspa C80-75 PLC Fault Table	6-5

Contents

CHAPTER 7 – MONITORING AND CONTROLLING ALSPA CE80–20 DATA

1.	OVERVIEW	7–2
1.1.	Forcing Circuits	7–2
1.2.	Overriding I/O Circuits	7–3
2.	MONITOR/CONTROL I/O DATA: HAND–HELD MONITOR	7–4
2.1.	Changing the Reference Type Being Displayed	7–5
2.2.	Stepping Through the Configured References of the Displayed Type	7–5
2.3.	Displaying a Specific Reference	7–5
2.4.	Displaying References that are Outside the BIU’s I/O Map	7–5
2.5.	Changing the Display Mode	7–5
2.6.	Returning to the Previous Menu	7–5
2.7.	Forcing/Unforcing the Displayed Reference	7–6
3.	MONITOR/CONTROL I/O DATA: ALSPA 8000 PLC	7–7
4.	MONITOR/CONTROL I/O DATA: COMPUTER	7–8

CHAPTER 8 – DATAGRAMS

1.	DATAGRAM TYPES	8–2
2.	READ MAP	8–3
3.	READ MAP REPLY	8–3
4.	WRITE MAP	8–4
5.	REPORT FAULT DATAGRAM FORMAT	8–5
5.1.	Fault Byte 1	8–5
5.2.	Fault Byte 2	8–5
5.3.	Fault Byte 3	8–6
5.4.	Fault Bytes 4 and 5	8–6
5.5.	Fault Bytes 6 and 7	8–6
6.	CONFIGURATION DATA	8–7
6.1.	Read Configuration Data	8–7
6.1.1.	Read Configuration Data Format for Alspa CE80–20 Conventional Modules	8–7
6.1.2.	Read Configuration Datagram Format for Alspa CE80–20 Intelligent Modules	8–7
6.2.	Read Configuration Reply Data	8–8
6.3.	Write Configuration Data	8–8
6.3.1.	Write Configuration Data Format for Alspa CE80–20 Conventional Modules	8–8
6.3.2.	Write Configuration Datagram Format for Alspa CE80–20 Intelligent Modules	8–9
6.3.3.	Bus Interface Unit Configuration Data Format	8–10
6.3.4.	Discrete Input Modules Configuration Data Format	8–11

6.3.5.	Discrete Output Modules Configuration Data Format	8-12
6.3.6.	Discrete Combination Input/Output Modules Configuration Data Format	8-13
6.3.7.	Conventional Analog Input Modules Configuration Data Format	8-14
6.3.8.	Analog Output Modules Configuration Data Format	8-16
6.3.9.	Intelligent Modules Configuration Data Format	8-17
6.3.9.1.	Configuration Data for Intelligent Modules, Bytes 0 to 13	8-18
6.3.9.2.	Additional Configuration Data for a 16 Point Grouped Analog Input Module	8-19
6.3.9.3.	Additional Configuration Data for an 8 Point Grouped Analog Voltage Input Module (ALG281)	8-20
6.3.9.4.	Additional Configuration Data for a 16 Point Grouped Analog Voltage Input Module (ALG282)	8-21
6.3.9.5.	Additional Configuration Data for an RTD Input Module	8-22
6.3.9.6.	Additional Configuration Data for a Thermocouple Input Module	8-23
6.3.9.7.	Additional Configuration Data for a Current Source Analog Output Module	8-24
6.3.9.8.	Additional Configuration Data for an Analog Voltage Output Module	8-25
6.3.9.9.	Additional Configuration Data for a Micro Field Processor Module	8-26
6.4.	Group Data Move Configuration Data Format	8-27
7.	SET BUS INTERFACE UNIT OPERATING MODE	8-29
8.	SET MICRO FIELD PROCESSOR OPERATING MODE	8-30
9.	INTELLIGENT ANALOG MODULE RECALIBRATION DATAGRAM	8-31
9.1.	Message Content for Calibrating Low End of Channel	8-31
9.2.	Message Content for Calibrating High End of Channel	8-31
9.3.	Field Recalibration	8-32
10.	READ I/O FORCES	8-33
11.	READ I/O FORCES REPLY	8-34
12.	READ SLOT DIAGNOSTICS	8-35
13.	READ SLOT DIAGNOSTICS REPLY	8-36

APPENDIX A – SCALING ANALOG CHANNELS

1.	HOW SCALING WORKS	A-1
2.	SCALING VALUES FOR 1MV OR 1MA ENGINEERING UNITS	A-2
2.1.	BIU Version 1.3	A-2
2.2.	BIU Version 2.0 or Later	A-3
3.	MEASURING SCALING VALUES	A-4
3.1.	Finding the Digital Value with the Module Online to the Process	A-4
3.2.	Finding the Digital Value without the Module Online	A-4
4.	EXAMPLE OF SCALING AN ANALOG INPUT	A-5

Contents

APPENDIX B – INSTALLING ADDITIONAL SUPPRESSION

1.	SUPPRESSION AT THE POWER LINES	B-1
2.	SUPPRESSION FOR DEVICES IN AN ENCLOSURE	B-2
3.	SUPPRESSION AT THE COMMUNICATIONS LINE	B-2

APPENDIX C – THE ALSPA N80 SERIAL BUS

1.	WIRING GUIDELINES	C-1
2.	ELECTRICAL INTERFACE	C-2
3.	SELECTING A CABLE TYPE	C-4
4.	SERIAL BUS WAVEFORMS	C-5
5.	USING OTHER CABLE TYPES	C-6
6.	PREFABRICATED CABLES	C-6
7.	EFFECT OF LONG CABLES, REPEATERS OR UNSPECIFIED CABLE TYPES ON MAXIMUM LENGTH BUS	C-7
	7.1. Attenuation	C-7
	7.2. Distortion	C-7
	7.3. Propagation Delay	C-8
8.	SERIAL DATA FORMAT	C-9
9.	BUS ACCESS	C-10
10.	BUS LENGTH	C-11
11.	BAUD RATE SELECTION	C-11
12.	BUS AMBIENT ELECTRICAL INFORMATION	C-12
	12.1. General	C-12
	12.2. Lightning Transient Suppression	C-12

APPENDIX D – CONFIGURATION EXAMPLES

Figure 1.1 – Alspa CE80–20 Station	1–1
Figure 1.2 – Types of Alspa CE80–20 modules	1–3
Figure 1.3 – N80 Network with Alspa CE80–20 stations (simple example)	1–8
Figure 1.4 – N80 Network with Alspa CE80–20 stations (more complex example)	1–9
Figure 1.5 – Alspa CE80–20 station with CPU redundancy	1–11
Figure 1.6 – Redundant bus configuration (first example)	1–12
Figure 1.7 – Redundant bus configuration (second example)	1–13
Figure 1.8 – Redundant bus configuration (third example)	1–13
Figure 2.1 – N80 BIU	2–1
Figure 2.2 – Timing chart for I/O module operation (with power loss)	2–3
Figure 2.3 – BIU input power requirements	2–4
Figure 2.4 – BIU terminal block connection	2–8
Figure 3.1 – System grounding	3–4
Figure 3.2 – BIU terminal block mounting holes	3–7
Figure 3.3 – BIU terminal block installation on DIN rail	3–8
Figure 3.4 – Location of terminal block connection cable	3–10
Figure 3.5 – Power wiring to BIU	3–11
Figure 3.6 – Communications bus connections on terminal block	3–12
Figure 3.7 – Bus cable	3–13
Figure 3.8 – Making bus connections	3–13
Figure 3.9 – Installation of terminating resistors	3–14
Figure 3.10 – Installation of pre-moulded bus cables	3–15
Figure 3.11 – Bus end cable	3–16
Figure 3.12 – Use of intermediate connector for critical processes	3–17
Figure 3.13 – Installation of BIU on terminal block	3–18
Figure 3.14 – BIU fuse location	3–20
Figure 4.1 – Synchronous Operation of a BIU and a Micro Field Processor	4–18
Figure 5.1 – Hand-Held Monitor–BIU connection	5–4
Figure 5.2 – Module slot numbers	5–19
Figure A.1 – Scaling an analog input	A–5

Tables

Table 2.1 – BIU LEDs – signalling	2–2
Table 4.1– Alspa CE80–20 contribution to N80 scan time	4–14
Table 8.1 – Datagrams for the BIU	8–2

Chapter *1* Introduction

This chapter introduces Alspa CE80–20 modules, the Alspa N80 Bus Interface Unit (BIU) and other equipment that may be used with the Bus Interface Unit. It will help you locate more information in other Alspa CE80–20 and N80 documents.

1. OVERVIEW OF ALSPA CE80–20

1.1. Description

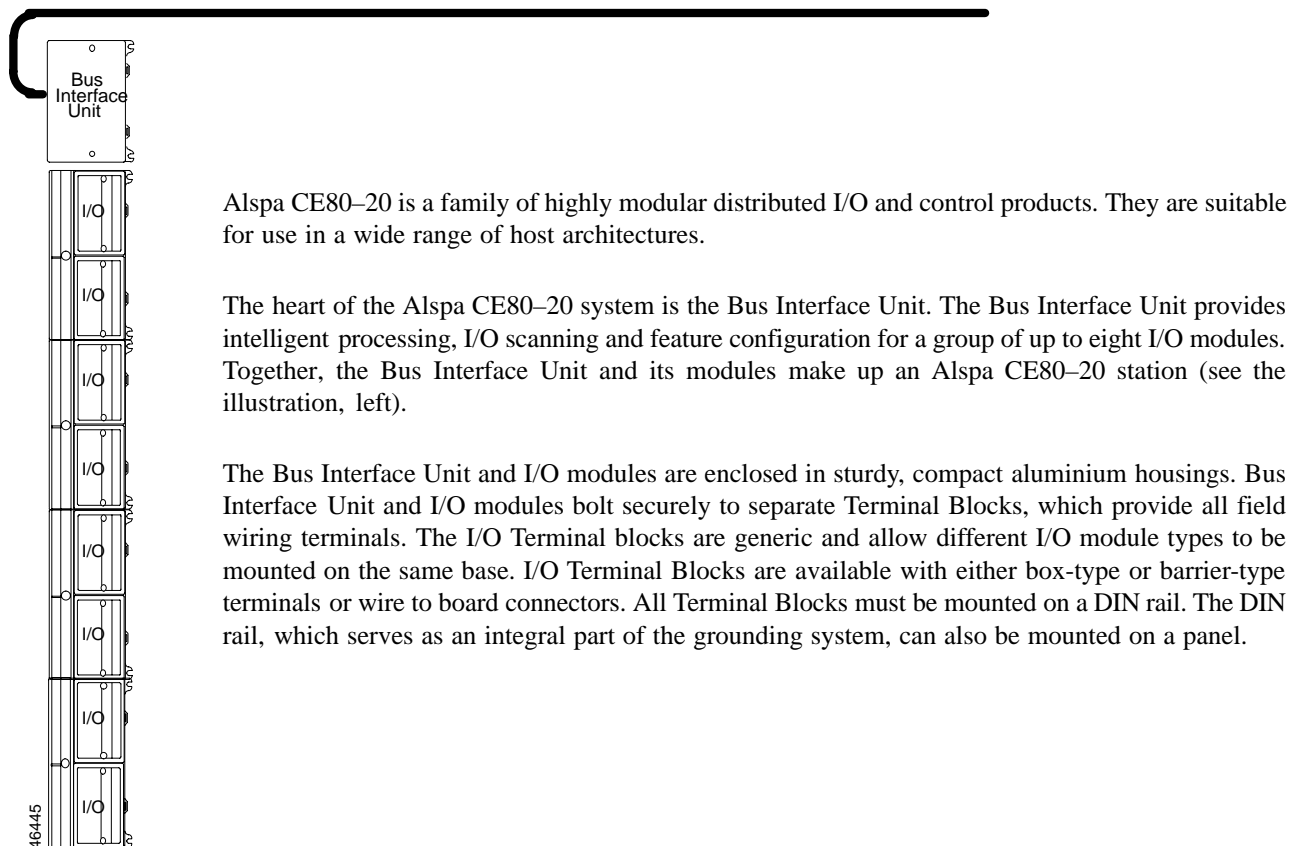

Figure 1.1 – Alspa CE80–20 Station

1.2. Features

Features and benefits of Alspa CE80–20 include:

- wiring savings,
- better up time,
- easy installation and maintenance,
- spare parts savings,
- low cost,
- feature flexibility,
- open architecture / adaptable to a variety of network,
- distributed I/O,
- small, compact I/O modules with generic terminal wiring bases,
- DIN rail mounted.

2. ALSPA CE80–20 MODULES

There are three basic types of Alspa CE80–20 modules:

- **Bus Interface Unit.** The illustration below shows an N80 Bus Interface Unit.
- **I/O modules:**
- **Micro Field Processor:**
- **Terminal Blocks:**
 - Bus Interface Unit Terminal Block.
 - I/O Terminal Blocks, each of which accommodates two I/O modules.
 - Auxiliary Terminal Blocks. These optional terminal strips can be connected to the side of an I/O Terminal Block if extra common terminals are needed.

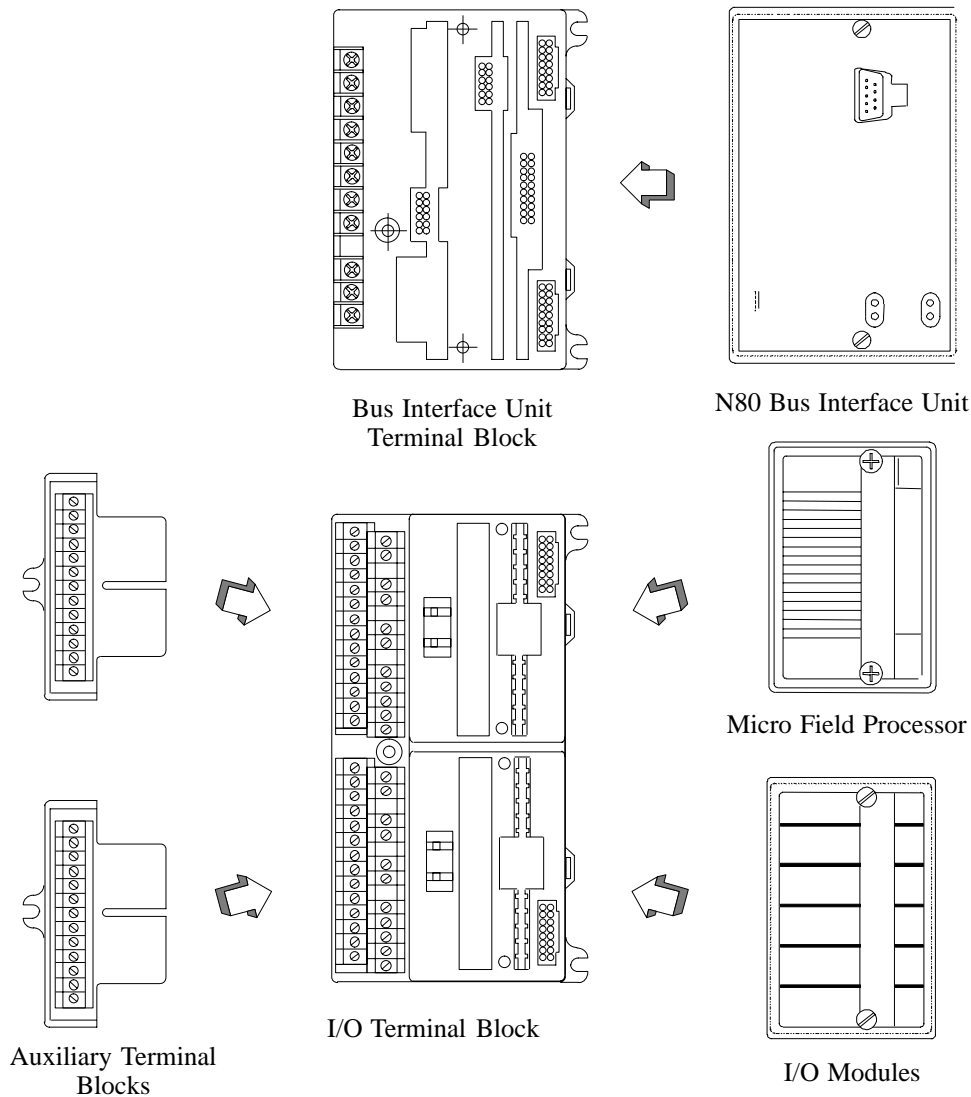

Figure 1.2 – Types of Alspa CE80–20 modules

2.1. N80 Bus Interface Unit

The N80 Bus Interface Unit (CE670GBI002/102) interfaces Alspa CE80–20 I/O modules to a host PLC or computer via an N80 network. It can exchange up to 128 bytes of input data and 128 bytes of output data with the host, each N80 bus scan. It can also handle N80 datagram communications.

The intelligent processing capabilities of the N80 Bus Interface Unit allow the configuration of features such as fault reporting, selectable input and output defaults, analog scaling and analog range selection for the modules in the station. In addition, the N80 Bus Interface Unit performs diagnostic checks on itself and its I/O modules, and relays diagnostic information to the host (if configured for fault reporting) and to a Hand-Held Monitor.

The N80 Bus Interface Unit can be used on a bus controlled by redundant CPUs or Bus Controllers. It can also be used on a dual bus.

The Bus Interface Unit mounts on a Bus Interface Unit Terminal Block. It can be removed and replaced if necessary without removing the wiring or reconfiguring the I/O station.

2.2. Bus Interface Unit Terminal Block

The Bus Interface Unit Terminal Block which is included with the BIU, has connections for power wiring and single or dual communications cables. It has built-in bus switching circuitry, allowing the Bus Interface Unit to be used on a dual (redundant) N80 bus (no external Bus switching Module is needed). The Bus Interface Unit Terminal Block stores the configuration parameters selected for the station.

2.3. I/O Modules

Alspa CE80–20 I/O Modules are available in many types to suit a wide range of application needs. Modules can be installed and removed without disturbing field wiring. One or two I/O modules may be mounted on an I/O Terminal Block.

2.4. Micro Field Processor

The Alspa 8000 Micro Field Processor (MFP) is a Micro PLC that provides local logic within an Alspa CE80–20 station. The Micro Field Processor is the same size as an Alspa CE80–20 I/O module and occupies one of the eight available I/O slots in an Alspa CE80–20 station.

MFP features include:

- Compatible with Alspa P8 programming software, revision 6.01 or later.
- Alarm processor.
- Password protection.
- Built-in communications port that supports Alspa 8000 protocols (SNP and SNPX).

The Micro Field Processor requires an N80 Bus Interface Unit revision 2.0 or later.

2.5. I/O Terminal Blocks and Auxiliary I/O Terminal Blocks

An I/O Terminal Block provides mounting, electrical and field wiring connections. Each half of the I/O Terminal Block can be mechanically keyed to accept only an I/O module of a specific type. Auxiliary I/O Terminal Blocks can be easily attached to an I/O Terminal Block. They can be used to provide additional common terminals if needed.

For more information, please refer to:

Chapter 2: Description, which describes the Bus Interface Unit and Bus Interface Unit Terminal Block in detail.

Chapter 3: Installation, which explains wiring to the Bus Interface Unit and explains how to install the Bus Interface Unit module on the Field Terminal Block.

Chapter 4: Operation, which explains how the N80 Bus Interface Unit services I/O.

Chapter 5: Station Configuration, which explains how to configure I/O modules.

The *ALS 52308 Alspa CE80–20 I/O Modules User's Manual* which describes I/O modules and I/O Terminal Blocks. This manual also explains module installation and field wiring.

3. ENVIRONMENTAL SPECIFICATIONS

Vibration Modules perform well where vibration is a factor. Designs are shock and vibration tested to meet the following specifications when installed on a panel-mounted DIN rail using the clamp supplied and with the panel-mounting feet secured:

IEC68–2–6: 10 to 57 Hz 0.012 in displacement (peak to peak)
57 to 500 Hz at 2 g (unless otherwise specified)
IEC68–2–27: Shock: 15G, 11 milliseconds, half sine wave

Noise Modules are resistant to noise levels found in most industrial applications when installed according to accepted practices, including proper separation of wiring by voltage and power levels, on a conductive (unpainted) DIN rail. The DIN rail is an integral part of the grounding system.

Modules are tested to the specifications listed in the *ALS 52612 Installation Requirements for Conformance to Standards*.

Temperature Modules operate reliably in ambient air temperatures from 0°C (32°F) up to 50°C (131°F). Storage temperatures are –40°C to +100°C.

Humidity 5% to 95%, non-condensing

For information about installing Alspa CE80–20 modules, please see:

Chapter 3 of this manual. It describes installation and wiring for the Bus Interface Unit module and terminal block.

Chapter 2 of the *ALS 52308 Alspa CE80–20 I/O Modules User's Manual*. It summarizes installation instructions for modules and terminal blocks.

The individual module datasheets included in the *ALS 52308 Alspa CE80–20 I/O Modules User's Manual*, which provide specific module wiring information.

Chapter 2 of the *ALS 52301 Alspa CE80–15 I/O System and Alspa N80 Communications Network User's Manual*, which includes detailed instructions for selecting and installing an N80 bus.

4. CONFIGURATION FOR ALSPA CE80–20

Configuration is an important part of the process of setting up an Alspa CE80–20 station. It establishes the following features:

- **For the Bus Interface Unit:**
 - N80 serial bus address,
 - Baud rate for N80 bus communications,
 - Fault reporting to the host,
 - Use of the Bus Interface Unit as a bus switching device in a dual (redundant) bus system,
 - Redundancy mode for CPU redundancy,
 - Configuration protection.
- **For I/O Modules:**
 - I/O addressing,
 - Whether faults will be reported to the host,
 - Hold Last State for inputs or outputs,
 - Output defaults,
 - Range selection for analog modules,
 - Scaling for analog modules,
 - Alarm limits for analog modules.
- **For a Micro Field Processor:**
 - Reference addresses,
 - Data lengths.

A Bus Interface Unit and I/O modules can be fully configured using a Hand–Held Monitor. Optionally, a previously–configured Bus Interface Unit can be reconfigured using datagrams.

For more information about configuration, please refer to:

Chapter 5 of this manual (*Station Configuration*). An N80 Hand–Held Monitor, version 4.6 (IC661HHM502J) or later, can be used to configure a Bus Interface Unit. HHM configuration instructions are given in chapter 5.

In addition, chapter 8 of this manual (*Datagrams*) explains how the configuration of a Bus Interface Unit can be completed or changed by sending it Write Configuration datagrams.

The *ALS 52314 Alspa CE80–20 Micro Field Processor User’s Manual*, which describes the Micro Field Processor (IC670MFP100), and provides installation procedures, operation information and diagnostics information.

If the system host is an Alspa C80–75 PLC, the N80 Bus Interface Unit must be included in the system configuration as a device on the bus. Please see the programming software documentation for instructions.

5. ALSPA CE80–20 IN AN ALSPA N80 NETWORK

Using Alspa CE80–20 modules on an N80 network combines the low cost, small size and flexibility of Alspa CE80–20 with the versatility and power of N80 communications.

The N80 bus is an industrially-hardened Local Area Network (LAN). It passes I/O (control) data and background information (datagrams) between the Bus Interface Unit and an N80 bus controller. An N80 can support up to 32 devices. Each Bus Interface Unit station counts as one device on the bus, regardless of the number or type of modules present in the station.

Other devices on the same bus can be Alspa CE80–20 stations, remote drops, I/O blocks, Bus Controllers and Hand–Held Monitors. Typical buses reserve one location for a Bus Controller and one for a Hand–Held Monitor, leaving 30 for additional devices. The illustration below shows an Alspa C80–75 PLC connected to an N80 bus with I/O blocks and two Alspa CE80–20 stations.

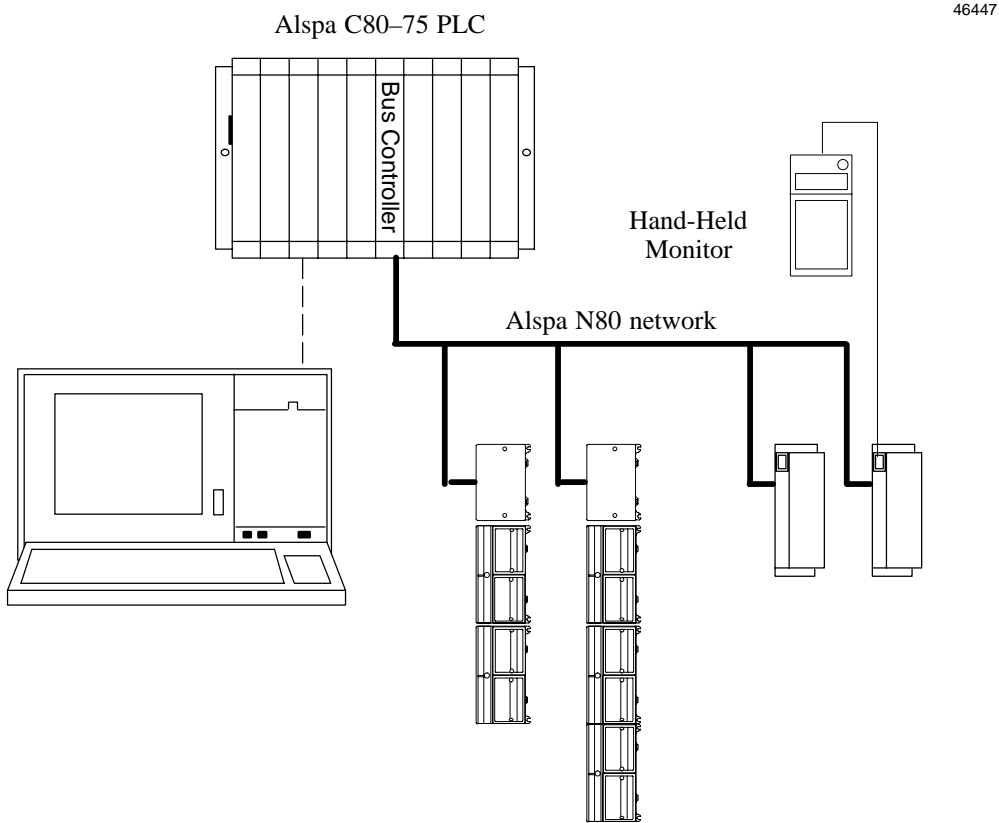

Figure 1.3 – N80 Network with Alspa CE80–20 stations (simple example)

5.1. The Host CPU

The N80 Bus Interface Unit is ideally suited for use with an Alspa 8000 PLC. However, any type of PLC or computer capable of controlling an N80 can be used as the host. Possible hosts include computers equipped with a PCIM (Personal Computer Interface Module), QBIM (Q–Bus Interface Module), or a third-party GENI-based interface module, including several in DCS systems.

5.2. A More Complex Alspa CE80–20 and N80 System

A more complex communications and control system is illustrated below. In this system, the Alspa CE80–20 stations and I/O blocks on the lower left are controlled by an Alspa C80–75 PLC. The Alspa CE80–20 stations and I/O blocks on the lower right are controlled by a host computer equipped with a PCIM (Personal Computer Interface Module).

The PLC communicates with a computer running programming software via an SNP (Serial Network Protocol) link. And the PLC, host computer, and programmer computer exchange system data via an Ethernet communications link.

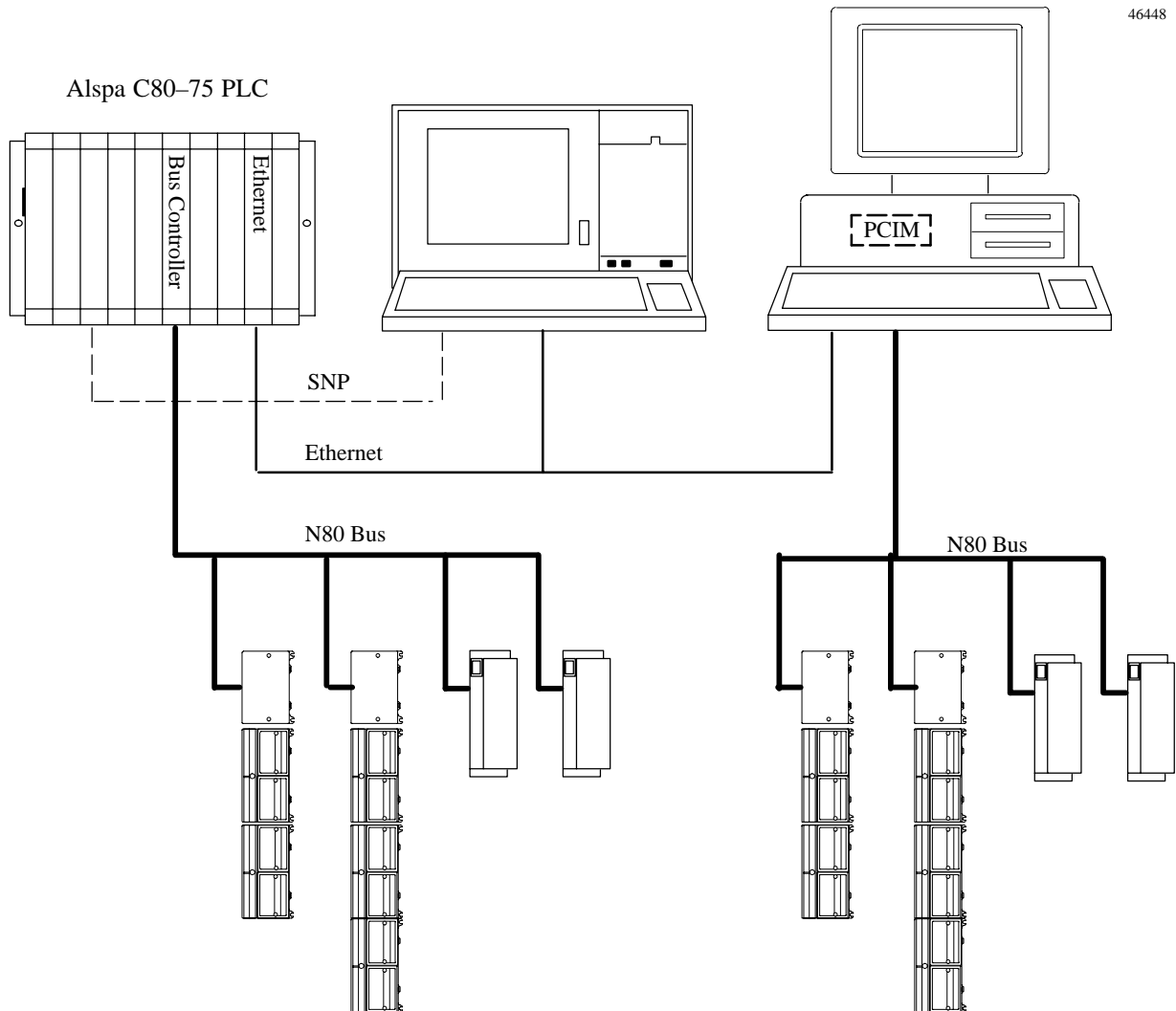

Figure 1.4 – N80 Network with Alspa CE80–20 stations (more complex example)

For more information about N80 systems and communications, please refer to:

The *ALS 52301 Alspa CE80–15 I/O System and Alspa N80 Communications Network User's Manual*, which describes N80 system operation, and communications formats.

The *Bus Controller User's Manual* for the system host, which includes specific system interface instructions.

6. REQUIRED HOST SYSTEM EQUIPMENT

The following system equipment is required:

- Hand-Held Monitor (IC661HHM502) version 4.6 or later.
- **For an Alspa C80-75 PLC**
 - The Alspa C80-75 CPU firmware release 3.0 or later.
 - The Alspa P8-75 programming and configuration software, release 3.0 or later.
 - An Alspa C80-75 N80 Bus Controller, release 3.0 or later. The Bus Controller must be 4.0 or later for full diagnostics display from Alspa P8-75 or for redundancy applications.
- **For an Alspa C80-35 PLC**
 - The Alspa C80-35 CPU firmware, any version.
 - The Alspa P8-75 programming and configuration software, any version.
 - The Alspa C80-35 N80 Bus controller, any version.
- **For a Host Computer**
 - PCIM: any version.
 - QBIM: any version.

7. USING ALSPA CE80–20 IN A CPU REDUNDANCY SYSTEM

Most systems use only one Bus Controller and CPU to control the I/O on the N80 network. CPU redundancy, which can be used for backup CPU/Bus Controller protection in critical applications, is described in detail in the specific documentation. This page summarizes how Alspa CE80–20 products can fit into a CPU Redundancy system.

7.1. CPU/Bus Controller Redundancy: Overview

In CPU redundancy, two Bus Controllers on the same bus can send control outputs at the same time. Both Bus Controllers automatically receive inputs and fault reports from all devices on the bus that have been configured as being in “CPU Redundancy” mode. The Bus Controllers must use serial bus addresses (device numbers) 30 and 31.

Alspa CE80–20 stations can be used on a bus controlled by redundant CPUs/Bus Controllers.

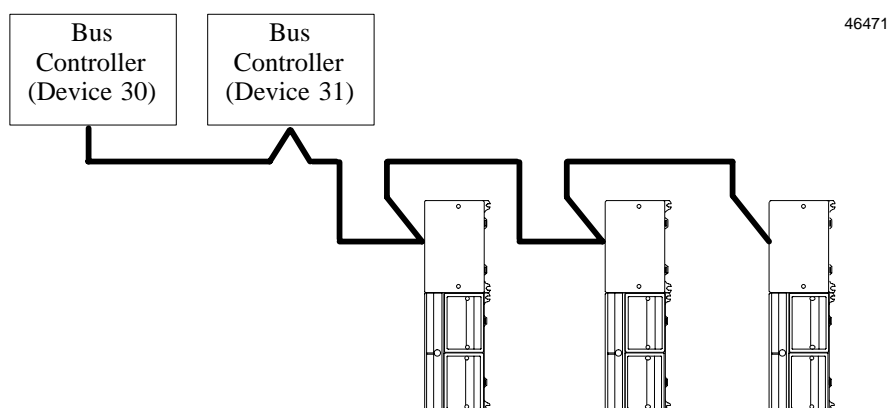

Figure 1.5 – Alspa CE80–20 station with CPU redundancy

How the two sets of outputs from the dual CPUs are handled by a Bus Interface Unit depends on whether the Bus Interface Unit is set up for Hot Standby or Duplex redundancy. *If the station contains any analog modules, the only form of CPU redundancy permitted is Hot Standby.*

7.2. Hot Standby CPU Redundancy

A Bus Interface Unit configured for Hot Standby mode is normally controlled by the Bus Controller assigned to serial bus address 31. If no outputs are available from 31 for three bus scans, the Bus Interface Unit accepts outputs from the Bus Controller assigned to serial bus address 30. If outputs are not available from either Bus Controller, outputs go to their configured defaults or hold their last state. In Hot Standby redundancy, Bus Controller 31 always has priority; when it is on-line, it has control of the outputs.

7.3. Duplex CPU Redundancy

A Bus Interface Unit configured for Duplex mode compares outputs it receives from the two Bus Controllers, to determine if they match. If corresponding outputs are the same, the Bus Interface Unit sets the output to that state. If corresponding outputs are not the same, the Bus Interface Unit sets the output to its configured ON or OFF Duplex Default State. If either Bus Controller stops sending outputs to a Bus Interface Unit, its outputs are directly controlled by the remaining Bus Controller. *Only discrete I/O modules can operate in Duplex redundancy mode; do not use Duplex mode if the station contains any analog I/O modules.*

8. USING ALSPA CE80–20 IN AN N80 REDUNDANCY SYSTEM

8.1. N80 Bus Redundancy: Overview

In N80 redundancy, there are two bus cables each connected to a Bus Controller. I/O devices may be connected to either one bus of the pair, or to both. However, a device that is connected to both buses actually communicates on only one bus at a time. Before the alternate bus can be used for communications, a bus switchover must occur and the device must “log in” with the Bus Controller(s) on the alternate bus.

The Bus Interface Unit Terminal Block contains a built-in bus switching relay that is used to switch busses in a dual bus system. Other types of devices with this capability are dedicated Bus Switching Modules and Alspa 80–75 Remote I/O Scanner modules. These are the only types of devices that can be directly connected to both redundant bus cables.

A Bus Interface Unit cannot be used as the BSM Controller for a bus stub. Other devices cannot be located on a stub downstream of a BIU.

Note that the N80 Bus Interface Unit should not be connected to an external Bus Switching Module.

8.2. Redundant Bus Configurations

Many different redundant bus configurations are possible. Three basic ways of using a Bus Interface Unit with a redundant bus are described below.

- **A Bus Interface Unit can be installed directly on both cables of the dual bus pair.** The Bus Interface Unit is configured to operate as a bus switching device in addition to performing its normal functions. Here, two Alspa CE80–20 stations are installed on a dual bus. Each Bus Interface Unit would be set up as a bus switching device.

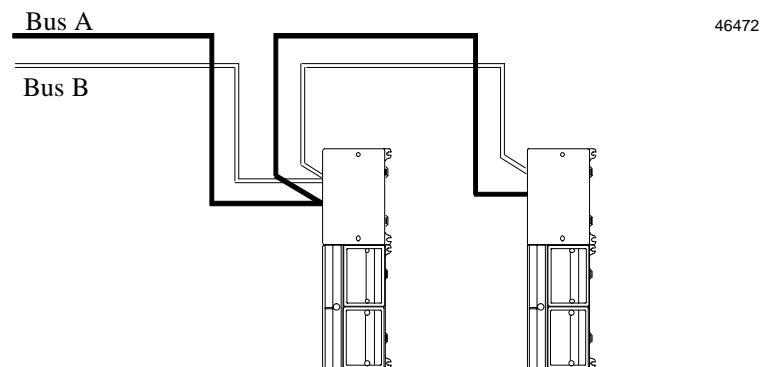

Figure 1.6 – Redundant bus configuration (first example)

- A **Bus Interface Unit can be located on just one bus of a redundant bus pair**, if bus redundancy is not needed for the modules in that station. In this example, the Bus Interface Unit on the left is connected to both Bus A and Bus B and is configured as a bus switching device. The Bus Interface Unit on the right, which serves non-critical I/O modules, is connected to Bus A only, and is not configured as a bus switching device.

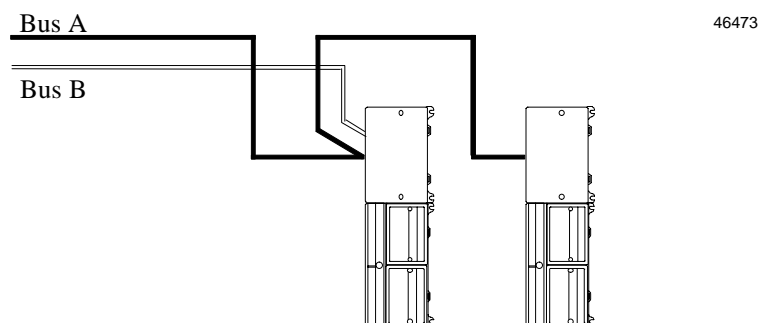

Figure 1.7 – Redundant bus configuration (second example)

- A **Bus Interface Unit can be located on a bus stub**. A Bus Interface Unit can also be located on a bus stub, which is a short length of unterminated cable downstream of either an I/O block/Bus Switching Module combination, or a Remote I/O Scanner connected to a dual bus. Because the bus stub cable itself is not redundant, this type of installation does not provide as much protection as connecting directly to a dual bus. The bus switching device to which the bus stub is connected can be another I/O block with a Bus Switching Module attached, as shown below, or an Alspa C80-75 Remote I/O Scanner.

In this example, there are two Alspa CE80-20 stations installed on a bus stub. Each is configured as “BSM Present” but not configured as a “BSM Controller”.

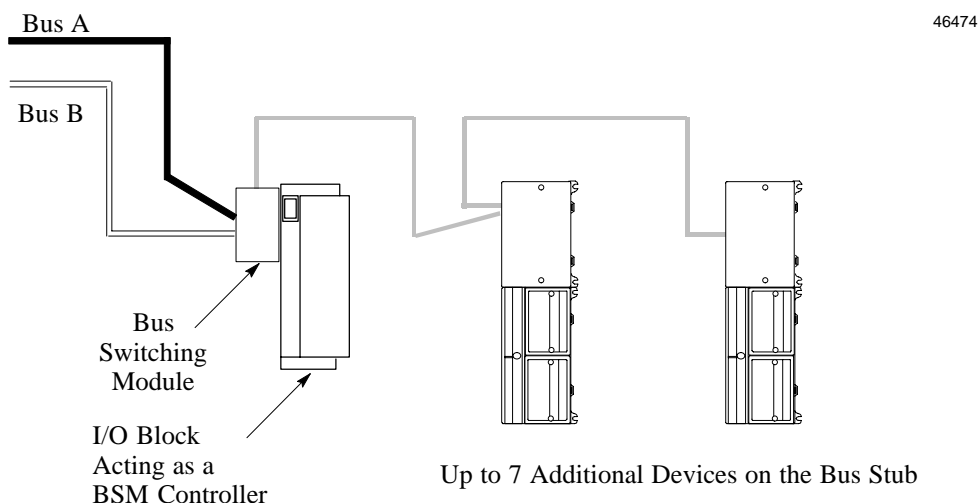

Figure 1.8 – Redundant bus configuration (third example)

Up to seven devices (not counting the BSM/block or Remote I/O Scanner to which the dual bus is connected) can be installed on a bus stub. Each device on a bus stub counts toward the total of 32 devices on the N80 network.

Restrictions on the number and length of bus stubs that may be used on a dual bus are explained in the *ALS 52301 Alspa CE80-15 I/O System and Alspa N80 Communications Network User's Manual*.

Chapter 2 Description

This chapter describes:

- N80 Bus Interface Unit,
 - Bus Interface Unit Power Supply,
- Bus Interface Unit Terminal Block,
- Specifications.

1. N80 BUS INTERFACE UNIT

The N80 Bus Interface Unit is a small, rugged, intelligent module with a sturdy aluminum housing. The module has four status LEDs described below and a connector for attaching a Hand-Held Monitor.

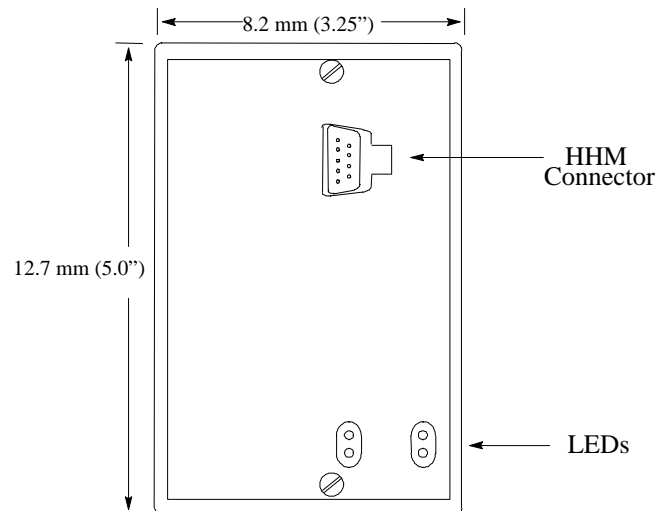

Figure 2.1 – N80 BIU

The Bus Interface Unit contains the logic power supply needed to operate the I/O modules connected to it. It mounts on a separate terminal block, to which it and all bus wiring are attached. The configuration is stored in non-volatile memory located in the terminal block. Both the power supply and terminal block are described in this chapter.

The Bus Interface Unit has a replaceable 1A, 5x20 mm 250 VAC slow-blow fuse on the input power lines. The fuse can be changed without disturbing the wiring of any other modules (instructions are in chapter 3).

1.1. LEDs

The LEDs on the Bus Interface Unit show its operating status.

46496

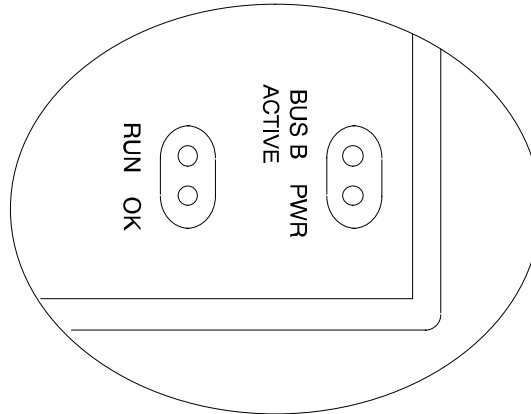

- PWR** lights to indicate that + 5 V power is available for logic operation.
- OK** lights to indicate that the module has passed its power-up diagnostic tests. See the table below for more information.
- RUN** lights only if output modules are in the BIU configuration and are written to by the controlling bus controller.
- BUS B** if the Bus Interface Unit is installed on a dual (redundant) bus, this LED lights if Bus B is the currently-active bus.

OK	RUN	Meaning
ON	ON	Module functioning, CPU communicating
ON	OFF	Module functioning, no CPU communications for 3 bus scans
ON	Blinking	Module functioning, circuit forced
Blinking	ON	Circuit fault, CPU communicating
Blinking	OFF	Circuit fault, no CPU communications for 3 bus scans
Alternate Blinking		Circuit fault, Circuit forced
Synchronous Blinking		No CPU communications – block number conflict
OFF	Blinking	Electronics/Terminal Assembly mismatch
OFF	OFF	No block power or Block faulty

Table 2.1 – BIU LEDs – signalling

1.2. Bus Interface Unit Power Supply

The 24 VDC power supply in the Bus Interface Unit provides power for the Bus Interface Unit itself and logic power for all I/O modules that may potentially be installed at that station. External power must be supplied for bus wiring of input and output devices.

The power supply is not damaged by either of the following:

- Reversing input voltage on terminals 1 and 2.
- *Temporary* overcurrent conditions on the 6.5 VDC output.

1.3. Timing

The Bus Interface Unit provides power to all I/O modules that are installed at the station. I/O module operation is governed by a System Reset signal to ensure controlled operation during the power up and shut down processes. As shown in the timing diagram below, momentary power losses of less than 10 ms (for 24 VDC BIU) or 20 ms (for 115 VAC/125 VDC BIU) do not affect I/O module operation. Longer power losses generate a Reset for all system I/O modules.

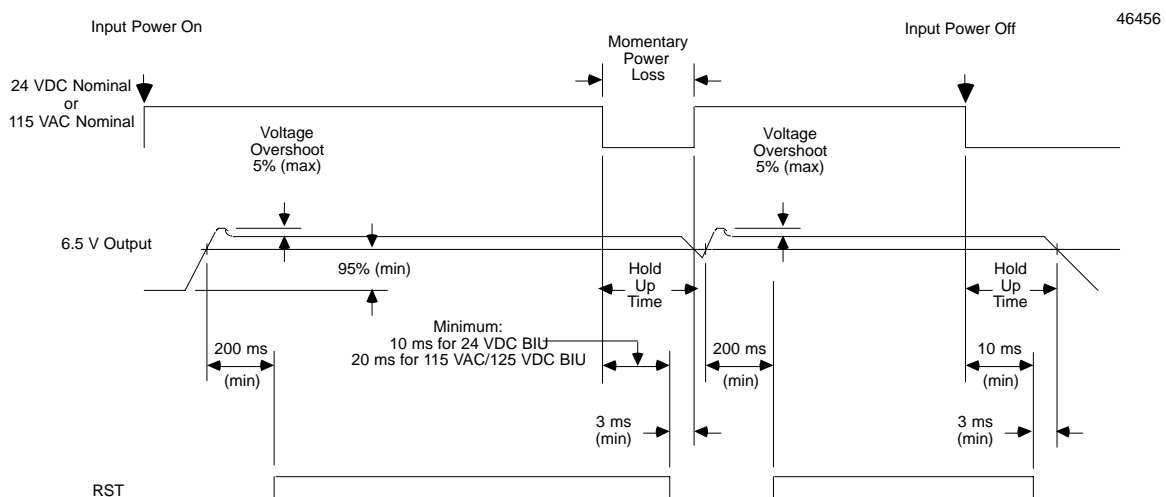
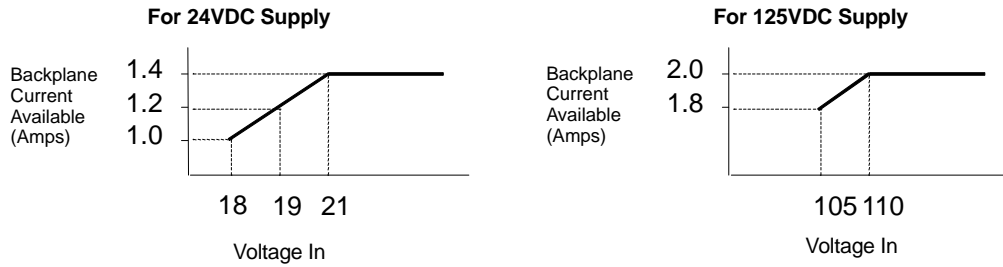

Figure 2.2 – Timing chart for I/O module operation (with power loss)

1.4. Backplane Current

With a DC input voltage, the amount of current available to the backplane may be limited by lower input voltage as indicated below.



1.5. Calculating Input Power Requirements for a Bus Interface Unit

The chart below shows typical input power requirements for a Bus Interface Unit.

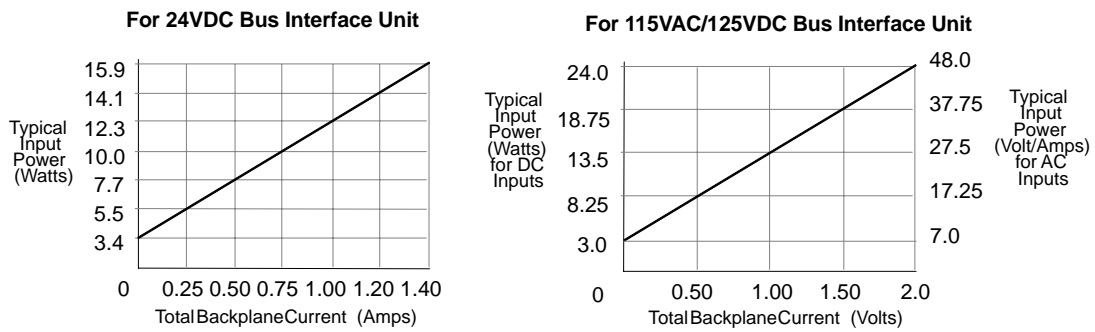

Figure 2.3 – BIU input power requirements

Note

For a 24 VDC Bus Interface Unit, start-up surge at full load is 15–50 Amps for 3 milliseconds (maximum). For a 115 VAC/125 VDC Bus Interface Unit, start-up surge at full load is 20 Amps peak for 3 ms.

To determine specific system requirements:

- Determine total output load from typical specifications listed for individual modules.
- Use the appropriate graph of input power above to determine average input power.
- Divide the input power by the operating source voltage to determine the input current requirements.
- Use the lowest input voltage to determine the maximum input current.
- Allow for start-up surge current requirements. Start-up surge current levels are a function of source impedance and, therefore, are installation-dependent. Start-up surge currents can vary for approximately 3 ms. For the 24 VDC Bus Interface Unit, variance is between 25 A and 50 A. For the 115 VAC/125 VDC Bus Interface Unit, start-up surge current is 20 A maximum peak.

1.6. Bus Interface Unit Power Dissipation

The Bus Interface Unit power dissipation can be determined once the backplane current supplied to the I/O modules is known.

The following equation can be used to calculate BIU power dissipation:

$$\text{BIU Power Dissipation} = \text{Input Power} - (\text{total backplane current} \times 6.5 \text{ volts})$$

For example:

- A. Total backplane current = 0.5 Amps
- B. Typical Input power = 7.7 Watts

Therefore:

$$\text{BIU Power Dissipation} = 7.7 \text{ W} - (0.5 \times 6.5) = 4.45 \text{ Watts}$$

1.7. Load Requirements for Hardware Components

The table below shows the DC load required by each module and hardware component. All ratings are in milliamps. Input and Output module current ratings are with all inputs or outputs on. These are maximum requirements, not typical.

Catalog Number	Description	Current (mAmps)
IC670MDD441	Mixed I/O Module, 24 VDC, 10 Inputs, 6 Outputs	100
IC670MDL233	Input Module, 120 VAC 8 Isolated Points	40
IC670MDL240	Input Module, 120 VAC 16 Grouped Points	77
IC670MDL241	Input Module, 16 Points, 2 groups 240 VAC	77
IC670MDL640	Input Module, 24 VDC 16 Grouped Pos/Neg Points	83
IC670MDL641	Input Module, 48 VDC 16 Grouped Pos/Neg Points	83
IC670MDL642	Input Module, 125 VDC 16 Grouped Pos/Neg Points	77
IC670MDL643	Input Module, 5/12 VDC 16 Point	80
IC670MDL644	Input Module, 12/24 VDC 16 Grouped Pos/Neg Fast Inputs	80
IC670MDL730	Output Module, 8 Pt 24 VDC Electronic Short Circuit Protection	125
IC670MDL740	Output Module, 12/24 VDC 0.5 Amp, 16 Grouped Pos.	111
IC670MDL742	Output Module, 5/12/24 VDC Negative Outputs	111
IC670MDL330	Output Module, 16 Point 12–120 VAC 16 Pt 1.0 Amp	285
IC670MDL331	Output Module, 120 VAC 2 Amp, 8 Isolated Points	154
IC670MDL930	Relay Output Module, 2 Amp, 6 Form A Points and 2 Isolated Form C Points	313
IC670ALG230	Analog Current Input Module, 8 Grouped Points	51
IC670ALG240	Analog Input Module, 16 Grouped Points	251
IC670ALG281	Analog Voltage Input Module, 8 Grouped Points	150
IC670ALG282	Analog Voltage Input Module, 16 Grouped Points	150
IC670ALG620	RTD Input Module	190
IC670ALG630	Thermocouple Input Module	195
IC670ALG320	Analog Current/Voltage Output Module, 4 Grp Points	51
IC670ALG330	Analog Current source Output Module, 8 Points	85
IC670MFP100	Micro Field Processor	111
IC693PRG301	Hand-Held Programmer	170
IC661HHM502	Hand-Held Monitor	0

1.8. Hand-Held Monitor and Hand-Held Programmer

The Hand-Held Monitor (IC661HHM502), used for configuring and monitoring the BIU and does not add to the load on the BIU.

However, if a Hand-Held Programmer (IC693PRG301) will be attached to a Micro Field Processor or other module in the I/O Station, it must be considered as a load component as listed above.

1.9. Hot Insertion/Removal of Modules

Bus Interface Units CE670GBI002(F) and CE670GBI102(A) or later support Hot Insertion/Removal of modules in the I/O Station.

Hot Insertion/Removal means that modules can be removed and replaced while I/O Station power is applied without affecting the BIU or other modules in the I/O Station. Separate I/O module power must be switched off to the module being inserted or removed.

Hot Insertion/Removal requires the use of specific modules and I/O terminal blocks:

- I/O modules having catalog number suffix J or above. These modules have a projecting alignment tab that fits into a corresponding alignment tab on I/O Terminal Blocks listed below. Note that modules with this tab can also be installed on older I/O Terminal Blocks that do not have mating alignment tabs. However, Hot Insertion/Removal are not supported in such an installation.
- I/O Terminal Blocks IC670CHS101, 102 or 103. These I/O Terminal Blocks have projecting alignment tabs designed to facilitate Hot Insertion/Removal of modules. Modules that are earlier than revision J cannot be mounted on these terminal blocks.

I/O Terminal Blocks IC670CHS001, 002 and 003, which lack alignment tabs, do not support Hot Insertion/Removal of modules. With these terminal blocks, I/O Station power should be off when installing or removing modules.

Mixing IC670CHS10x terminal blocks with IC670CHS00x terminal blocks in the same I/O station is not recommended.

1.9.1. Faults Reported During Hot Insertion/Removal

When using the recommended equipment listed above, Hot Insertion/Removal will cause the expected fault reports related to the loss of or addition of the module and its I/O circuits. These faults should be cleared in the normal manner. However, Hot Insertion/Removal of a rev. J or later module will NOT cause Configuration Mismatch errors that in some types of systems can shut down the controller.

1.9.2. I/O Module Data During Hot Insertion/Removal

As mentioned, separate I/O module power must be turned off for Hot Insertion/Removal. When the module is installed and power is reapplied, module data will quickly return to normal. For intelligent I/O modules, there may be a delay of a few seconds while the module goes through its powerup sequence.

1.9.3. Hot Insertion/Removal for a Micro Field Processor

A Micro Field Processor that is revision J or later may be removed/inserted as described above. Note, however, that although the Micro Field Processor will start functioning upon reinstallation, the MFP's application program must be reloaded. I/O data controlled by the Micro Field Processor will be incorrect until that has been done. (The BIU configuration of the Micro Field Processor is not affected by Hot Insertion/Removal).

1.9.4. Hot Insertion/Removal Not Permitted in Hazardous Locations

In hazardous locations, I/O Station power must be turned off before inserting/removing module. Failure to observe this precaution may result in personal injury, system malfunction and/or damage to the equipment.

2. BUS INTERFACE UNIT TERMINAL BLOCK

The Bus Interface Unit provides terminals for power and ground connections. Maximum wire size is 2.10 mm² cross-section (AWG No. 14).

The Bus Interface Unit Terminal Block also has eight input terminals for connection to a single or dual N80 bus. These terminals accommodate up to two 2.10 mm² (AWG No. 14 wires). The Bus Interface Unit Terminal Block contains bus-switching circuitry permitting it to be used *as a BSM Controller* in a dual bus redundancy system.

A connecting cable is provided with each I/O Terminal Block. It is used to connect the Bus Interface Unit Terminal Block to the first I/O Terminal Block. The same type of cable interconnects subsequent I/O Terminal Blocks. The cable has moulded connectors that are keyed to assure proper orientation.

The Bus Interface Unit terminal block is designed to be extremely reliable; it should not be necessary to replace or rewire it after installation.

The Bus Interface Unit Terminal Block stores the configuration parameters for the station. The Bus Interface Unit can be removed without removing the wiring or reconfiguring the station.

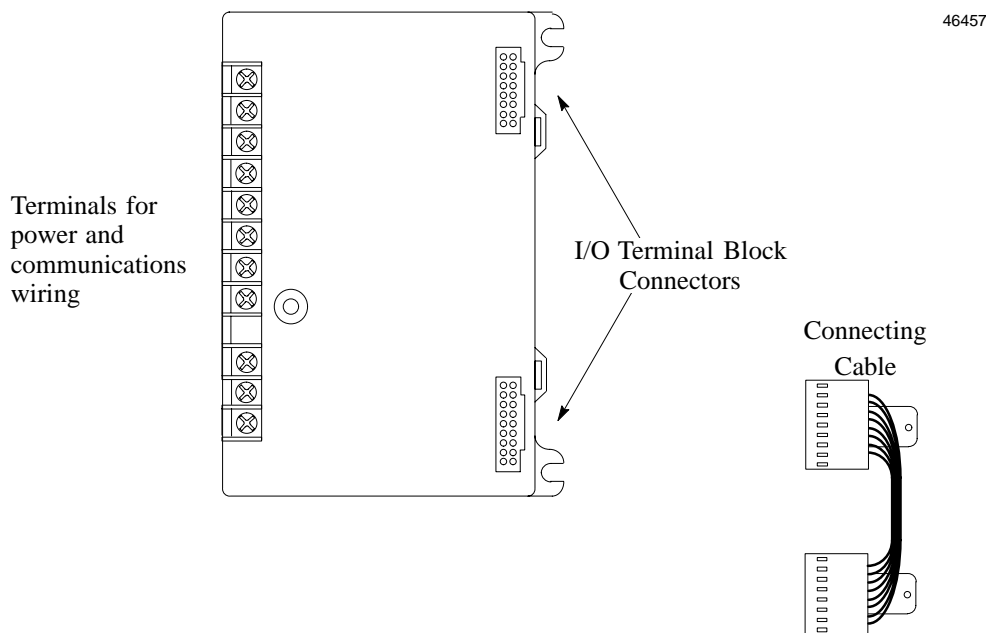

Figure 2.4 – BIU terminal block connection

Specifications for the Bus Interface Unit terminal block are listed in Section 3. Wiring information is in chapter 3.

3. FUNCTIONAL SPECIFICATIONS

Bus Interface Unit: Reliability 24 VDC Power Supply Input Nominal Rated Voltage Voltage Range Power Inrush Current Power Supply Output To I/O modules: Holdup Time	More than 183,000 hours operation MTBF, calculated 24 VDC 18 VDC to 30 VDC 16.8 Watts maximum at full load (nominal voltage) 15–50 Amps peak, 3 ms maximum (see note) 6.5 VDC \pm 5% 1.4 Amp maximum 10 ms maximum
115 VAC/125 VDC Power Supply Input Nominal Rated Voltage Voltage Range Frequency (AC) Power Inrush Current Power Supply Output to I/O modules: Holdup Time	115 VAC, 125 VDC 90 to 135 VAC, 105 to 150 VDC 47 to 63 Hz 115 VAC: 48 VA maximum at full load (nominal voltage) 125 VAC: 24 W maximum at full load (nominal voltage) 20 Amps peak, 3 ms maximum. See Note. 6.5 VDC \pm 5% 2 Amp maximum. 20 ms maximum from nominal input voltage.
Bus Interface Unit Terminal Block: Power Requirements Reliability	16 mA maximum More than 600,000 hours operation MTBF, calculated

For information about I/O modules, please see the *ALS 52308 Alspa CE80–20 I/O Modules User’s Manual*.

Note

Inrush current is installation dependent. See Subsection 1.4.

Chapter *Installation*

3

This chapter describes:

- System Wiring Guidelines,
- System Grounding,
- Locations for Alspa CE80–20 Modules,
- Installing the Bus Interface Unit Terminal Block on a Panel,
- Installing the Bus Interface Unit Terminal Block on a DIN Rail,
- Installing the Cables Between Terminal Blocks,
- Power Wiring to the Bus Interface Unit,
- Connecting the Communications Bus,
- Installing/Removing the Bus Interface Unit,
- Removing/Replacing the Bus Interface Unit Fuse,
- Upgrading the BIU firmware.

For information about installing I/O module, see the *ALS 52308 Alspa CE80–20 I/O Modules User’s Manual*.

For a detailed description of the characteristics of the Alspa N80 bus, see Appendix C “The Alspa N80 Serial Bus”.

1. PREINSTALLATION CHECK

Carefully inspect all shipping containers for damage during shipping. If any part of the system is damaged, notify the carrier immediately. The damaged shipping container should be saved as evidence for inspection by the carrier.

As the consignee, it is your responsibility to register a claim with the carrier for damage incurred during shipment. However, ALSTOM will fully cooperate with you, should such action be necessary.

After unpacking the Alspa CE80–20 modules and other equipment, record all serial numbers. Serial numbers are required if you should need to contact Product Service during the warranty period of the equipment.

All shipping containers and all packing material should be saved should it be necessary to transport or ship any part of the system.

2. STATIC PROTECTION

The Bus Interface Unit has CMOS components that are susceptible to static damage. *Use proper static handling techniques when handling this module.*

3. HAND-HELD MONITOR CONNECTOR

The connector on the Alspa CE80–20 Bus Interface Unit is intended for use with a Hand-Held Monitor only. It must be connected to a nonincendive circuit only.

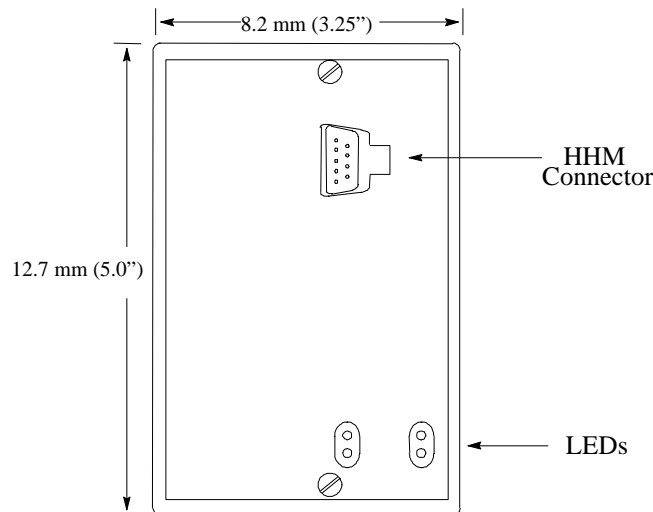

4. SYSTEM WIRING GUIDELINES

4.1. Types of Wiring

Four types of wiring may be encountered in a typical factory installation:

1. Power wiring – the plant power distribution, and high power loads such as high horsepower motors. These circuits may be rated from tens to thousands of KVA at 220 VAC or higher.
2. Control wiring – usually either low voltage DC or 120 VAC of limited energy rating. Examples are wiring to start/stop switches, contactor coils and machine limit switches. This is generally the interface level of the discrete I/O.
3. Analog wiring – transducer outputs and analog control voltages. This is the interface level to I/O analog blocks.
4. Communications and signal wiring – the communications network that ties everything together, including computer LANs, Ethernet and N80 I/O and communications bus.

These four types of wiring should be separated as much as possible to reduce the hazards from insulation failure, miswiring and interaction (noise) between signals. A typical PLC system with remote I/O may require some mixing of the latter three types of wiring, particularly in cramped areas inside motor control centers and on control panels. In general, it is acceptable to mix the communications bus cable with the I/O wiring from the blocks, as well as associated control level wiring. All noise pickup is cumulative, depending on both the spacing between wires and the distance span they run together. I/O wires and communications bus cable can be placed randomly in a wiring trough for lengths of up to 15 meters (50 feet). If wiring is cord-tied (harnessed), do not include the bus cable in the harness, since binding wires tightly together increases the coupling and mechanical stress that can damage the relatively soft insulation of some serial cable types.

Wiring which is external to equipment, and in cable trays, should be separated following NEC practices.

4.2. Installing Additional Suppression

It is possible some installations might exceed the surge immunity capabilities specified in chapter 1. This is most likely in outdoor installations or where the power source is from another building or ground system. It is prudent to provide local transient protection.

Appendix B describes installation of additional suppression at the power and communications lines.

5. SYSTEM GROUNDING

All components of a control system and the devices it controls must be properly grounded. Ground conductors should be connected in a star fashion, with all branches routed to a central earth ground point as shown below. This ensures that no ground conductor carries current from any other branch.

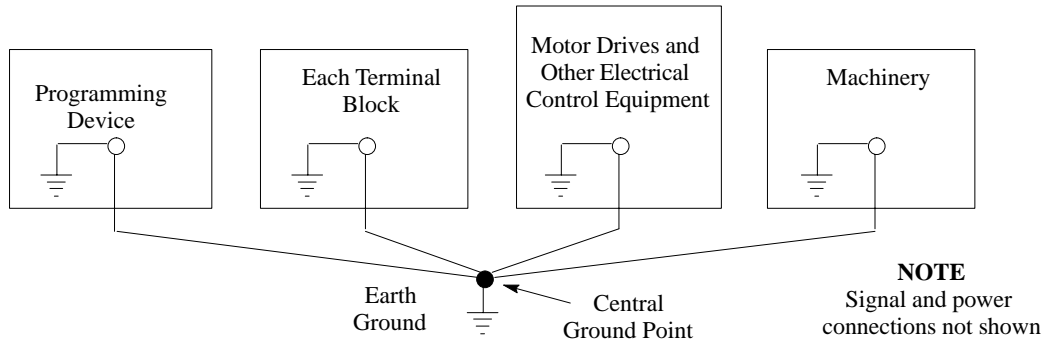

Figure 3.1 – System grounding

Each Alspa CE80–20 Terminal Block has a chassis ground terminal for safety and noise protection. This terminal should be connected to the conductive mounting panel with a 10 cm (4-inch) maximum length of 2.10 mm² (AWG No. 14) wire. Use hardware such as star washers to ensure ground integrity.

The control panel and enclosure should also be bonded to the plant system ground per code. Inadequate grounding may compromise system integrity in the presence of power switching transients and surges.

6. LOCATIONS FOR ALSPA CE80–20

Alspa CE80–20 terminal blocks must be installed on a 35 mm x 7.5 mm DIN rail. Modules can be located on equipment, in junction boxes, inside panels, behind operator stations, in NEMA enclosures as little as 4” deep and in other locations where space is limited. The area should be clean and free of airborne contaminants, with adequate cooling airflow.

Modules can be mounted in any orientation without derating the temperature specification. They can be installed in a linear stack as shown on the left in the following illustration, using the short connection cables provided with each I/O Terminal Block. An optional 0.53 meter (21 inch) cable (IC670CBL002) is also available. Only one 21” cable can be used per Alspa CE80–20 station.

All of the I/O Terminal Blocks in a group must be connected either at the top or the bottom of the Bus Interface Unit (BIU in the illustration). A Bus Interface Unit may not be connected between I/O Terminal Blocks.

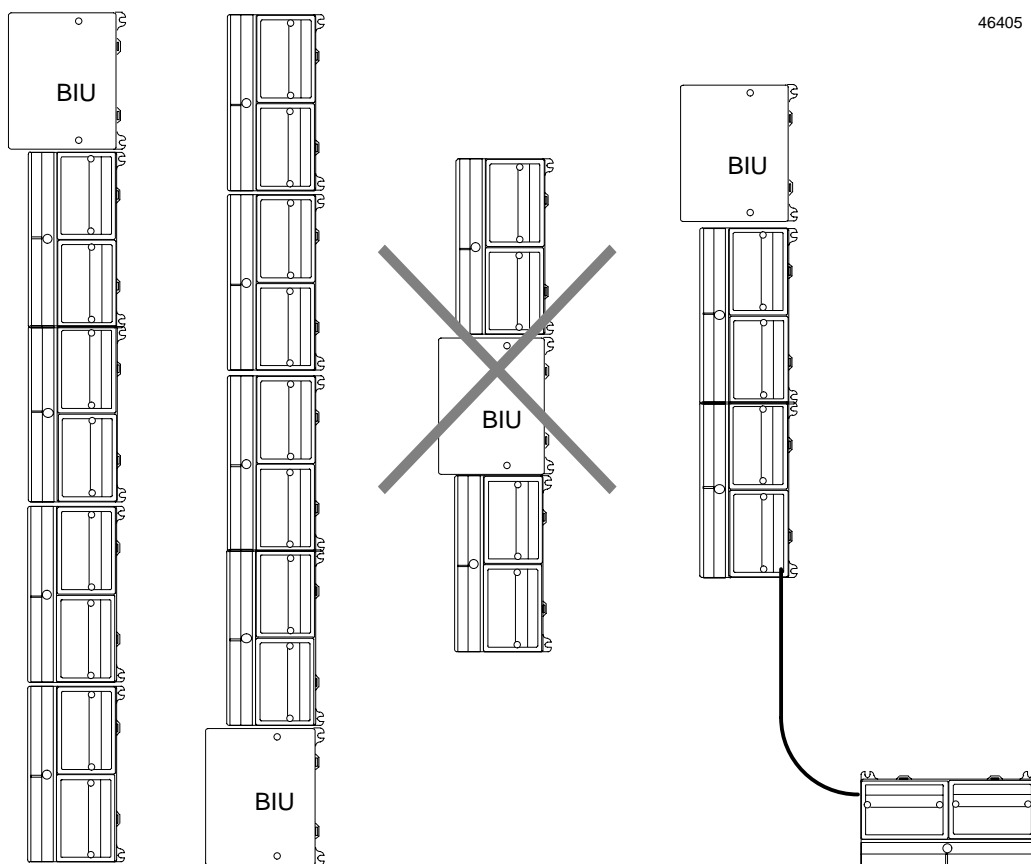

7. INSTALLING THE DIN RAIL

All Alspa CE80–20 Terminal Blocks must be mounted on a 7.5 mm x 35 mm DIN rail. The rail must have a conductive (unpainted) finish for proper grounding.

For best vibration resistance, the DIN rail should be installed on a panel using screws spaced approximately 15 cm (6 inches) apart. When using multiple rail sections, be sure they are properly aligned.

Mount the DIN rail at least 10.80 cm (4.25 inches) from any wireway or other obstruction *on the wiring side of the Bus Interface Unit*. Allow more space if the wiring for I/O modules is very stiff. A wiring template is also provided in the instruction sheet included with each Bus Interface Unit terminal block.

Drill mounting holes for the BIU Terminal Block as shown below. Allow a small tolerance between the top and bottom of adjacent terminal blocks. After mounting the terminal blocks on the DIN rail as described on the following pages, use No.6 screws (not supplied) to attach them to the panel. Length for all screws is 9.525 mm (3/8 inch).

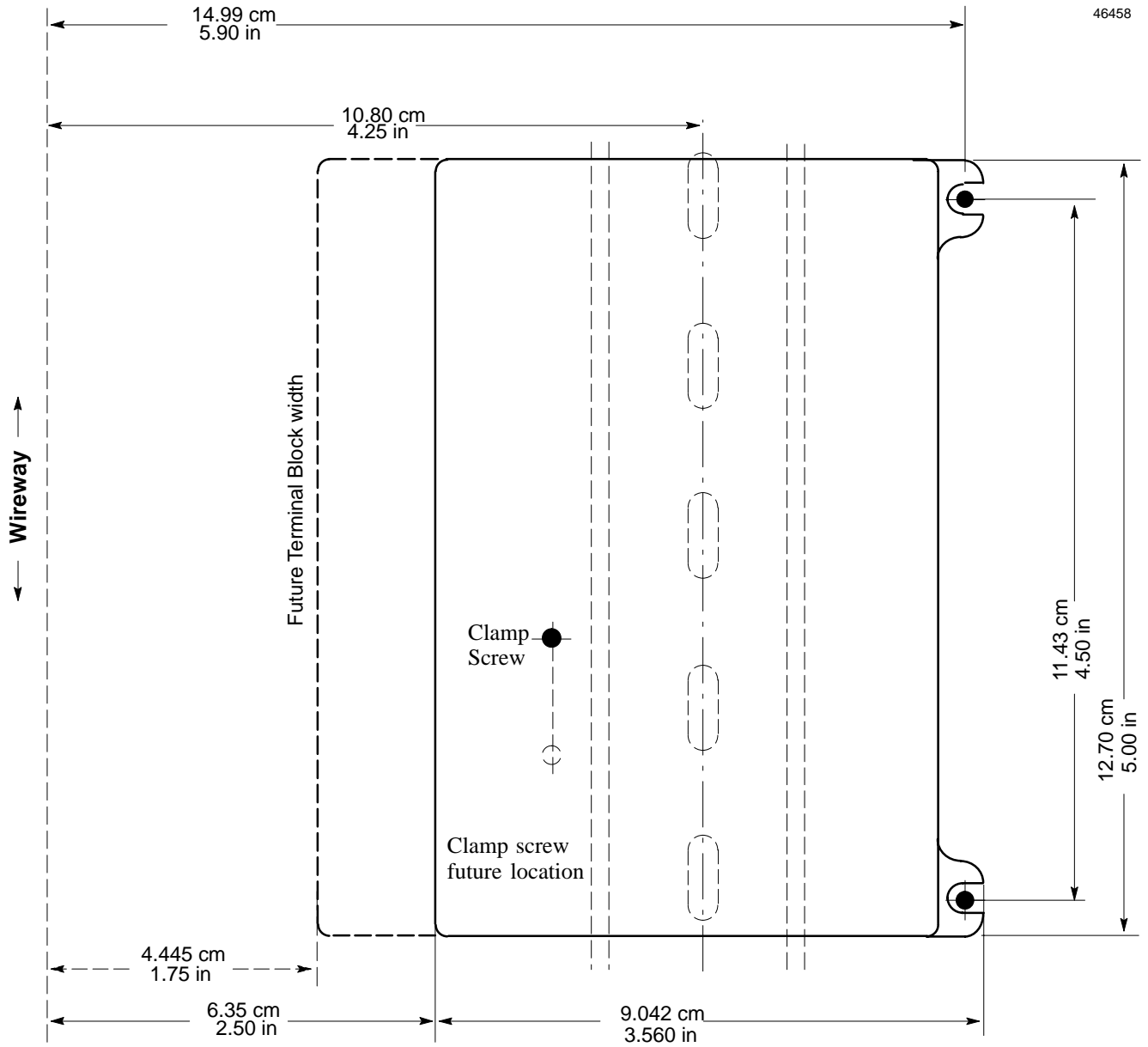
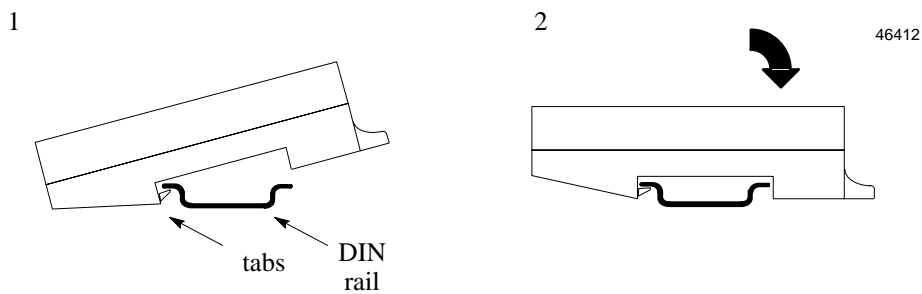

Figure 3.2 – BIU terminal block mounting holes

8. INSTALLING THE BUS INTERFACE UNIT TERMINAL BLOCK ON THE DIN RAIL

8.1. Installation

1. Tilt the Bus Interface Unit Terminal Block and position it over the rail, as shown below left, catching the rail behind the tabs in the terminal block.
2. Pivot the terminal block downward until the spring-loaded DIN rail latches in the terminal block click into place.



3. Tighten the DIN rail clamp screw (see below left). Maximum recommended torque is 0.45 Nm to 0.678 Nm (4 in/lbs to 6 in/lbs).

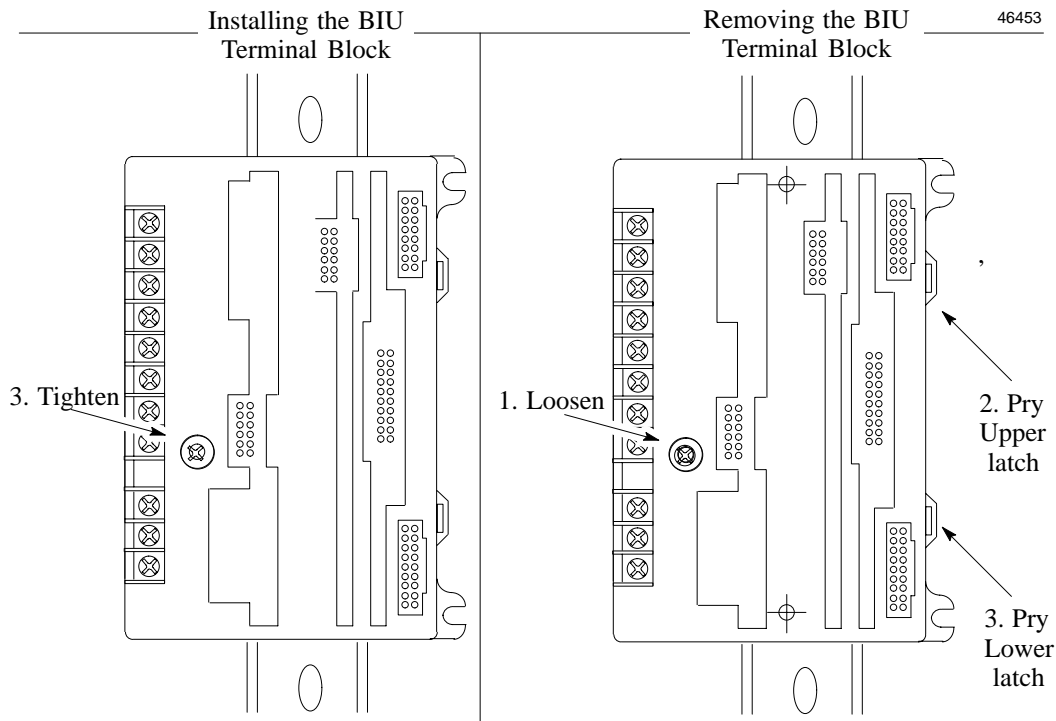

Figure 3.3 – BIU terminal block installation on DIN rail

8.2. Removal

1. Loosen the clamp screw.
2. Insert a small flat-blade screwdriver into the upper latch and pry it outward. Then, pull up gently on the top of the terminal block to disengage the upper latch from the rail.
3. Keep gently pulling the top of the terminal block away from the rail. Insert the screwdriver into the lower latch and pry it outward to free the terminal block.

9. INSTALLING THE CABLES BETWEEN TERMINAL BLOCKS

Before installing modules on their terminal blocks, install the connecting cable(s) between terminal blocks. A short connecting cable, as illustrated below, is supplied with each I/O Terminal Block. A set of three connecting cables is available as renewal part number IC670CBL001. Optional 0.53 meter (21 inch) cable is also available IC670CBL002 (only one cable can be used per I/O station).

The illustration below shows cable connection between a Bus Interface Unit terminal block and an I/O Terminal Block. Make connections between I/O Terminal Blocks in the same manner. The connectors are keyed to assure proper installation.

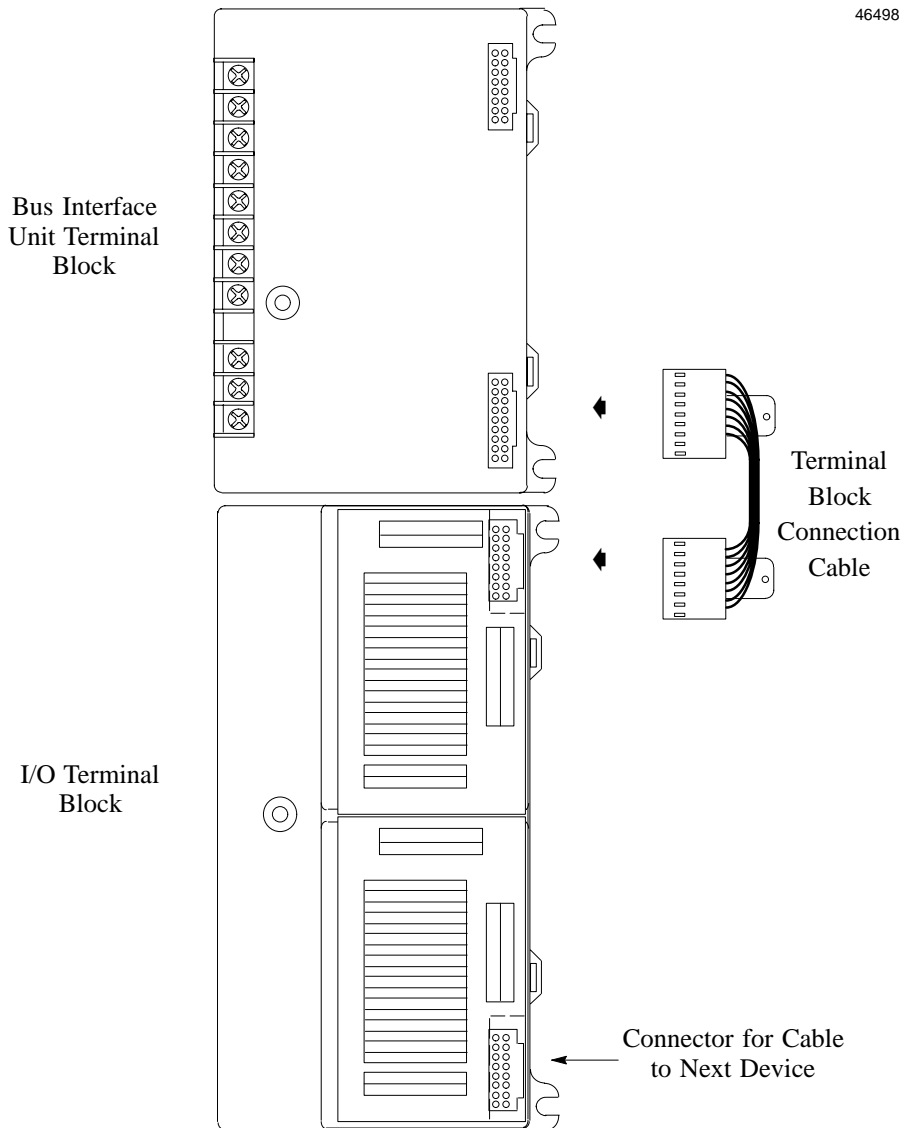

Figure 3.4 – Location of terminal block connection cable

After installing the cable, be sure it is firmly seated on both connectors.

10. POWER WIRING TO THE BUS INTERFACE UNIT

Note

Do not apply power until the BIU module is installed on the Terminal Block.

1. Connect an appropriate power source as shown below.

For BIU version CE670GBI102, if a DC supply is used the polarity is not important.

BIU version CE670GBI102 provides internal overvoltage protection. Terminal 4 is normally connected to frame ground (terminal 3) by a factory-installed jumper. If overvoltage protection is not required *or* is supplied upstream this feature can be disabled by removing the jumper, leaving pin 4 unconnected.

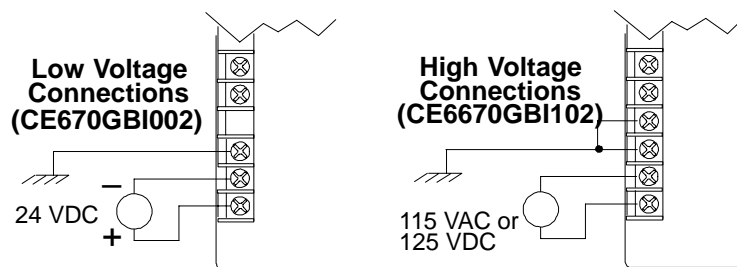

Figure 3.5 – Power wiring to BIU

2. Use one 2.10 mm² (AWG 14) or two 1.30 mm² (AWG 16) wires per terminal. The wires into a terminal should be the same type and size. Wires must be copper conductors rated for 75 degrees C (167 degrees F) only. Suggested torque for the terminal screws is 1.20 Nm (9 in/lbs).
3. Connect the ground terminal to the conductive mounting panel with a 10 cm (4-inch) maximum length of avg 2.10 mm² (AWG 14) or larger wire. Use hardware such as star washers to ensure ground integrity.

11. CONNECTING THE COMMUNICATIONS BUS

The Bus Interface Unit Terminal Block has a two sets of bus terminals. The terminals in the center portion of the terminal block are for the main bus cable; they are always used.

The outermost set of bus terminals is for an optional redundant (dual) bus cable. The Bus Interface Unit Terminal Block has built-in bus switching capability; *do not attach a Bus Switching Module in a dual bus application.*

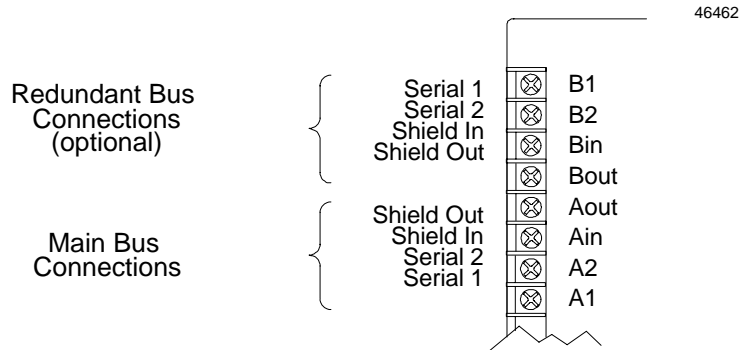

Figure 3.6 – Communications bus connections on terminal block

Terminals accept one or two 2.1 mm² (AWG No. 14 cross section) copper 75°C wires. Each terminal can accept solid or stranded wires. The wires on any terminal should be the same type. The suggested torque is 1.20 Nm (9 in/lbs).

11.1. Bus Cables

Bus connections can be made using standard bus cables (cable specifications for the N80 network are detailed in the Appendix C).

When making bus connections, the maximum exposed length of unshielded wires should be 5 cm (two inches). For added protection, each shield drain wire should be insulated with spaghetti tubing to prevent the Shield In and Shield Out wires from touching each other, or the signal wires.

For applications using 150 ohm cables, prefabricated cables are available in 38 cm (15”) (IC660BLC001) and 91 cm (36”) (IC660BLC003) lengths. These cables terminate in mating connectors that simplify wiring between I/O blocks. The 91 cm (36”) cable is recommended for Alspa CE80–20 installations.

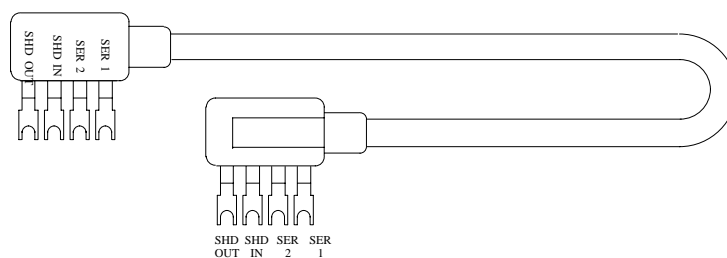

Figure 3.7 – Bus cable

11.2. Making Bus Connections

1. Connect Serial 1 to the Serial 1 terminals of the previous device and the next device.
2. Connect Serial 2 to the Serial 2 terminals of the previous device and the next device.
3. Connect Shield In to Shield Out of the preceding device. Connect Shield Out to Shield In of the next device. If the Bus Interface Unit is the first device on a bus, Shield In can be left unconnected. If it is the last device on a bus, Shield Out can be left unconnected.

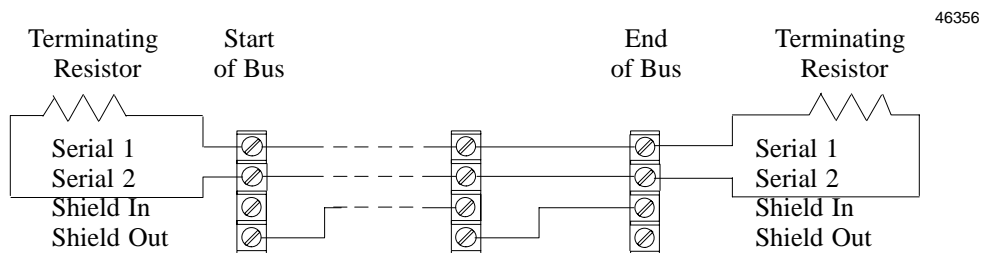

Figure 3.8 – Making bus connections

11.3. Terminating a Bus

If either bus will terminate at the Bus Interface Unit, connect a 75, 100, 120 or 150-ohm terminating resistor across the Serial 1 and Serial 2 terminals. Appendix C lists the correct impedance to use for each recommended type of bus cable.

Note

If the Bus Interface Unit will be powered up when not connected to a properly-terminated bus, connect a 75-ohm resistor across its Serial 1 and Serial 2 terminals to assure proper power-up.

11.3.1. Using Prefabricated Terminating Resistors

Prefabricated moulded connectors with terminating resistors are available for 75 ohms (catalog number IC660BLM508) and 150 ohms (IC660BLM506).

They can be used with conventional bus cable and with the cables with pre-moulded connectors. Attach the prefabricated resistor to the female cable end as shown below.

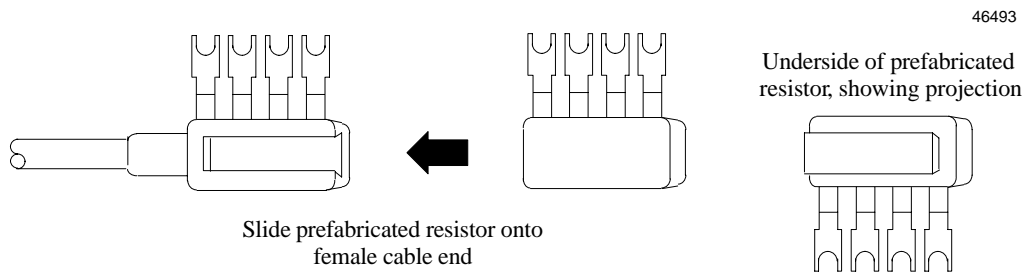

Figure 3.9 – Installation of terminating resistors

11.3.2. Installing Pre-Moulded Bus Cables

Pre-moulded cables must be installed in the orientation shown below. The main bus cable exits toward the power connections. The optional redundant bus cable exits away from the power connections.

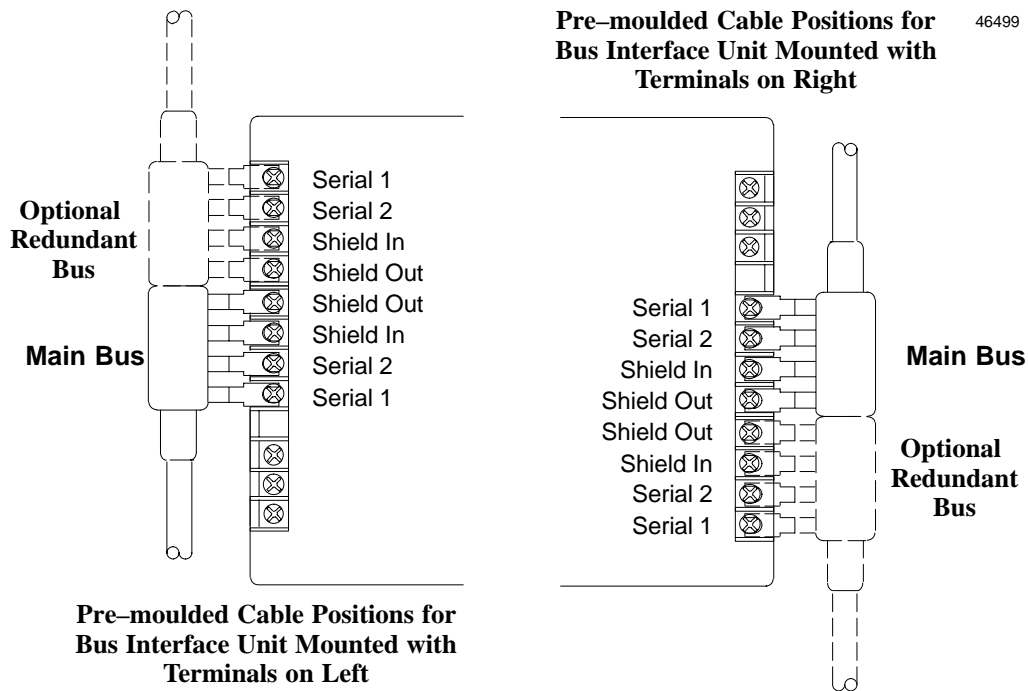

Figure 3.10 – Installation of pre-moulded bus cables

Where two prefabricated cable ends meet at the same device, join the male and female ends (see Figure 3.11).

If a prefabricated cable will be at the end of the bus (requiring termination, as explained), and you want to use a prefabricated terminating resistor, make the cable installation so that a female connector will be located at the device where the cable will be terminated.

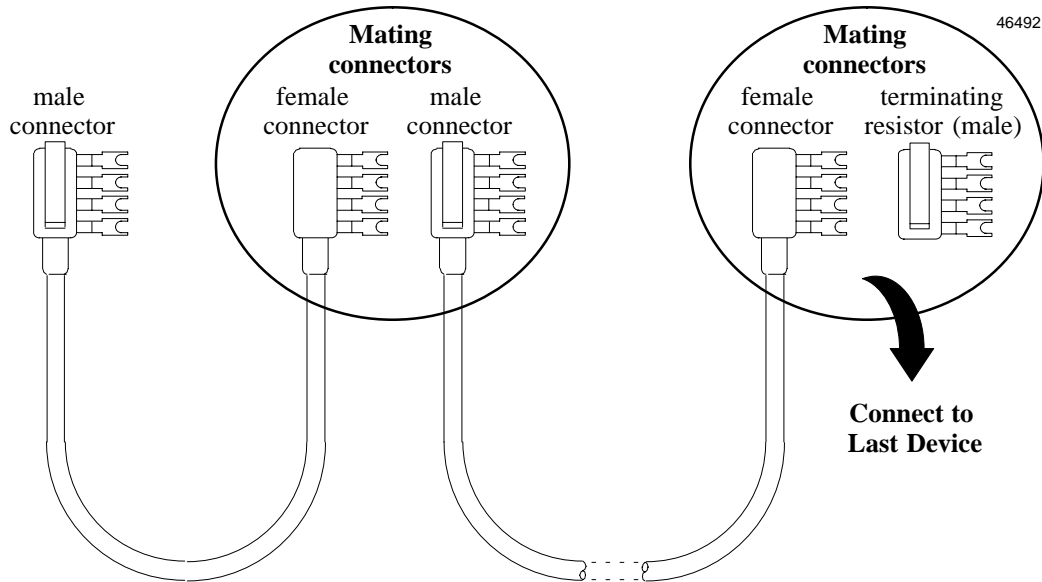

Figure 3.11 – Bus end cable

11.3.3. Bus Connection for Critical Processes

Bus connections are normally considered permanent. They should never be removed while the bus is in operation; the resulting unreliable data on the bus could cause hazardous control conditions.

If the bus controls critical processes that cannot be shut down, the Terminal Block can be wired to the bus via an intermediate connector as shown below.

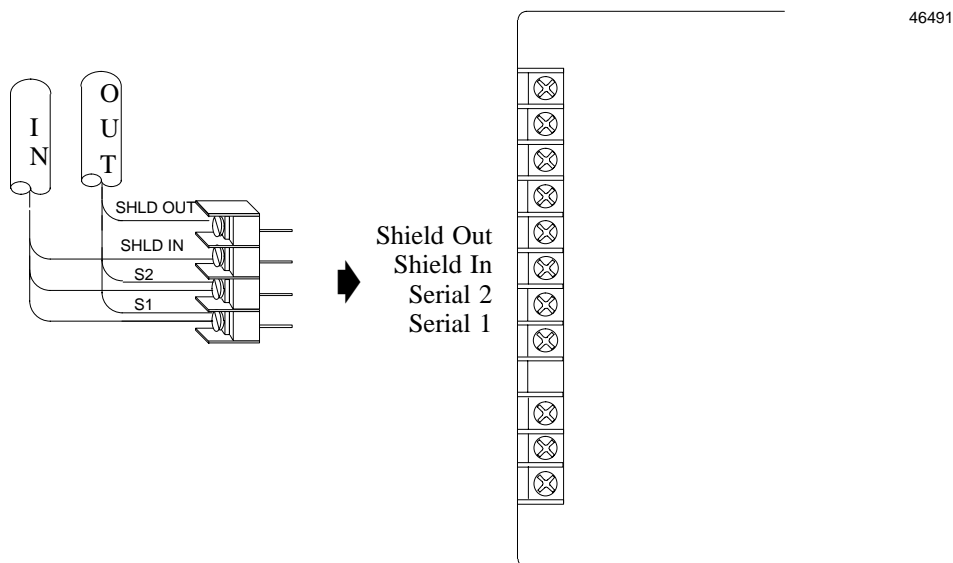

Figure 3.12 – Use of intermediate connector for critical processes

Alternatively, the wire ends can be soldered together before inserting them into the terminals. When removing the Terminal Block, cover the ends of the wires with tape to prevent shorting the signal wires to one another or to ground.

Both of these methods allow the Terminal Block to be removed while maintaining data integrity on the bus.

12. INSTALLING THE BUS INTERFACE UNIT ON THE TERMINAL BLOCK

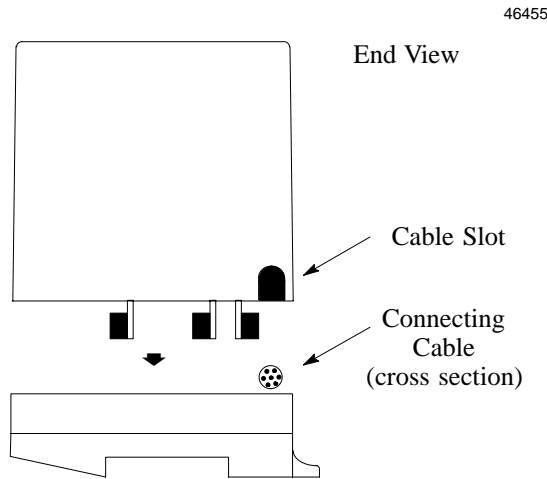

Figure 3.13 – Installation of BIU on terminal block

1. Before installing a new Bus Interface Unit, remove the cable slot knockout on the end of the module that will cover the connecting cable. It can be removed with pliers, or by pressing *out* from inside the module housing.
2. Power to the I/O Station should be OFF.
3. To install Bus Interface Unit on the terminal block, position the module so that the cable slot in the module housing is over the connecting cable. Press the module down firmly.

Caution

Excessive force may damage the equipment.

4. After placing the Bus Interface Unit onto the terminal block, tighten its screws to secure it. Maximum recommended torque is 1.20 Nm (9 in/lbs).

WARNING

Explosion hazard. When in hazardous locations, turn off power before replacing the BIU. Personal injury, system malfunction and/or damage to the equipment may occur.

Equipment labelled with reference to Class I, Groups A, B, C and D, Div. 2 hazardous locations is suitable for use only in non-hazardous locations or in Class I, Div. 2, Groups A, B, C and D locations.

Explosion hazard: Substitution of components may impair suitability for Class I, Division 2.

13. REMOVING THE BUS INTERFACE UNIT FROM THE TERMINAL BLOCK

1. Power to the I/O Station should be Off.
2. Loosen the Bus Interface Unit retaining screws.

Caution

Be sure screws are fully disengaged. Attempting to remove the module with screw(s) partially engaged may damage the equipment.

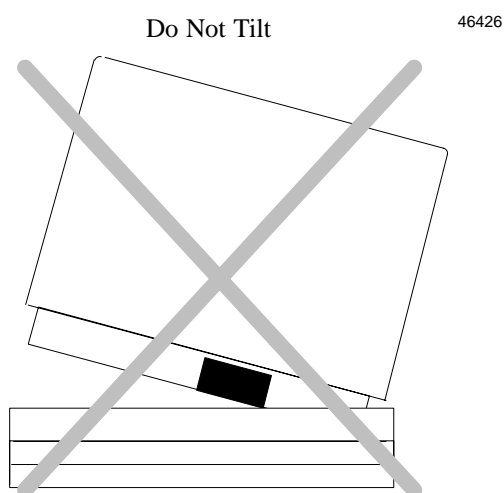

3. Pull the Bus Interface Unit module straight away from the Terminal Block.

Caution

Do not tilt the Bus Interface Unit to remove it. Attempting to remove the Bus Interface Unit at an angle may damage the equipment.

14. REMOVING/REPLACING THE BUS INTERFACE UNIT FUSE

If all the Bus Interface Unit LEDs go off, it may be necessary to replace its fuse. The fuse can be removed without disturbing any other parts of the station or wiring.

1. To check the fuse, remove power from the station.

Caution

Avoid touching the exposed wiring on the Terminal Block when removing the Bus Interface Unit.

Caution

Electrostatic discharge can damage the module when it is not installed on a Terminal Block. Always observe normal ESD protection practices when handling an un-installed module. Use of a ground cuff and a grounded floor surface are recommended.

2. Fully loosen the retaining screws in the Bus Interface Unit and carefully remove it from the Terminal Block. Do not tilt the module during removal.
3. Remove the retaining screws from the BIU.
4. The fuse location is shown below. Visually inspect the fuse to see whether it has blown.

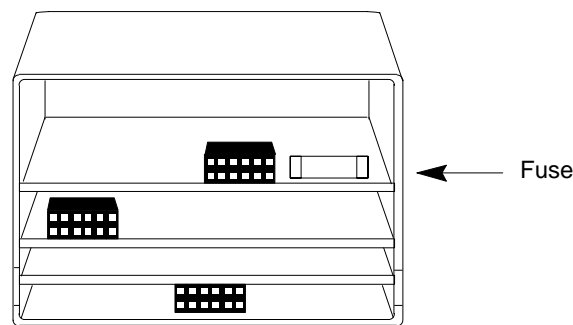

Figure 3.14 – BIU fuse location

5. To remove the fuse from the holder, carefully pry it upward. Take care not to damage any components in the module. Place the new fuse in position and press it into the holder.

The fuse should be a 1A, 5x20 mm 250 VAC slow-blow type.

6. Reinstall the Bus Interface Unit on the BIU Terminal Block as described on the previous page.

15. UPGRADING THE BIU FIRMWARE

Note

The BIU EEPROM stores the configuration of the I/O Station. If you replace the BIU EEPROM, it will be necessary to reconfigure the I/O Station using a Hand-Held Monitor.

Follow the steps below to replace the BIU's firmware EEPROM.

Caution

Avoid touching the exposed wiring on the Terminal Block when removing the Bus Interface Unit.

Electrostatic discharge can damage the module when it is not installed on a Terminal Block. Always observe normal ESD protection practices when handling an un-installed module. Use of a ground cuff and a grounded floor surface are recommended.

1. Remove power to the I/O Station.
2. Fully loosen the retaining screws in the Bus Interface Unit and carefully remove it from the Terminal Block. Do not tilt the module during removal.
3. Remove the retaining screws from the BIU.
4. The firmware EEPROM is located on the 2-board set that also includes the Hand-Held Monitor connector. This set of two boards and their plastic card guide must be removed from the module housing.

46546

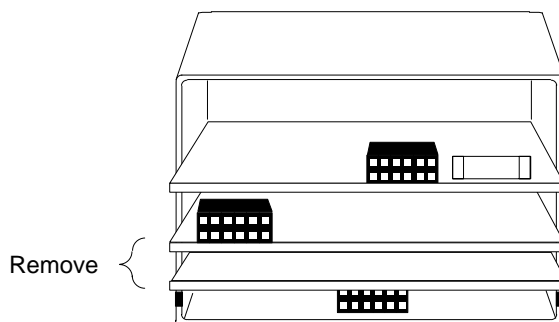

Note the position of the card guide with respect to the metal housing for reassembly.

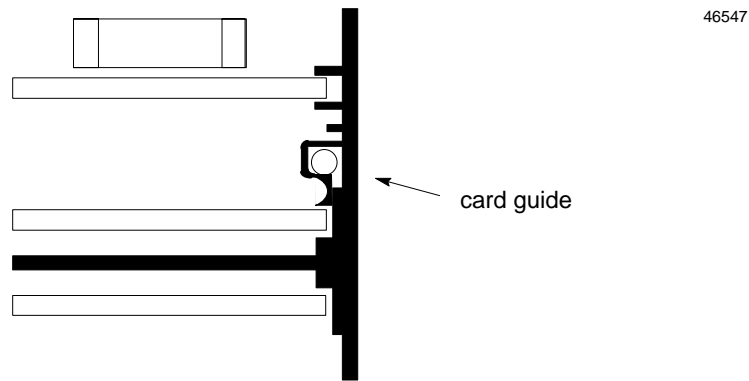

5. Hold your hand behind the module to retain the board set and turn the module face up.
6. Insert a small screwdriver or similar tool into either of the holes from which you previously removed the module retaining screws. Pry the two halves of the plastic latch inward to free that side of the card guide. Repeat on the other side.

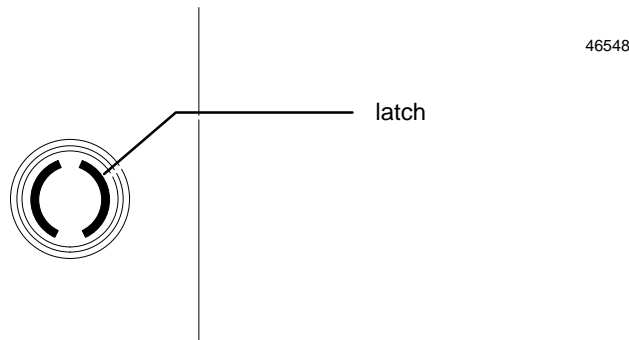

7. Remove the dual board set and card guide from the housing.
8. Replace the EEPROM on the board with the EEPROM containing the new firmware for the BIU.
9. Reinsert the board set into the module housing, taking care to align the card guide with the screw holes in the housing.
10. When the card guide is in position, press downward gently on the back of the card guide to seat the latches. Check the front of the module to be sure they have seated correctly.
11. Reinstall the Bus Interface Unit on the BIU Terminal Block.
12. Using a Hand-Held Monitor version 4.6 or later, reconfigure the I/O Station.

Chapter *Operation*

4

This chapter explains how a Bus Interface Unit interacts with the modules in its station, how it stores data and how it exchanges data with the system host.

- ◆ BIU Data Handling at the I/O Station,
- ◆ The BIU Sweep,
- ◆ BIU Backplane Scan Time,
- ◆ Data Transfer Between the BIU and the Host,
- ◆ N80 Bus Scan Time,
- ◆ Operation of the BIU with a Micro Field Processor,
- ◆ Backing Up Micro Field Processor Outputs,
- ◆ Backing Up BIU Outputs with a Micro Field Processor.

1. BIU DATA HANDLING AT THE I/O STATION

The BIU manages all movement of data within the I/O station and between the I/O station and the N80 bus. The BIU scans the I/O modules in the station, exchanges data with the host and can manage the exchange of data between a Micro Field Processor and other modules in the station. In addition to its regular I/O scanning capabilities, the BIU can also selectively transfer specific data groups from one intelligent module in the station to another.

All of the data for the I/O station, whether it is data that is exchanged on the N80 bus or local data, utilizes the BIU's four I/O data memories.

The BIU has 256 bytes of memory available for each of the four types of data (discrete inputs and outputs, data types I and Q and analog inputs and outputs, data types AI and AQ). During BIU configuration, data for individual modules is assigned to specific areas of this memory.

BIU Memory Type Designation	Typically Used For	Amount Available in BIU	Highest Available Reference Address
I	discrete inputs and status data from intelligent modules	256 bytes	65535
Q	discrete outputs and fault clearing for intelligent modules	256 bytes	65535
AI	analog inputs	256 bytes	9999
AQ	analog outputs	256 bytes	9999

Data can be configured anywhere within the BIU's available memory. If the data will be exchanged on the network bus, data must be assigned to contiguous memory locations, as explained later.

The following paragraphs describe the types of data the BIU exchanges with conventional I/O modules and intelligent I/O modules.

1.1. I/O Data for Conventional Modules

Conventional I/O modules provide or receive just one type of I/O data (sometimes referred to as *reference data*). Normally, this data is assigned to the data types shown below; however, any module's data can be assigned to any data type in BIU memory.

Type of Module	Type of Data
discrete inputs	I
analog inputs	AI
discrete outputs	Q
analog outputs	AQ

The BIU reads inputs from all conventional input modules and sends outputs to all conventional output modules during every "sweep" of operations.

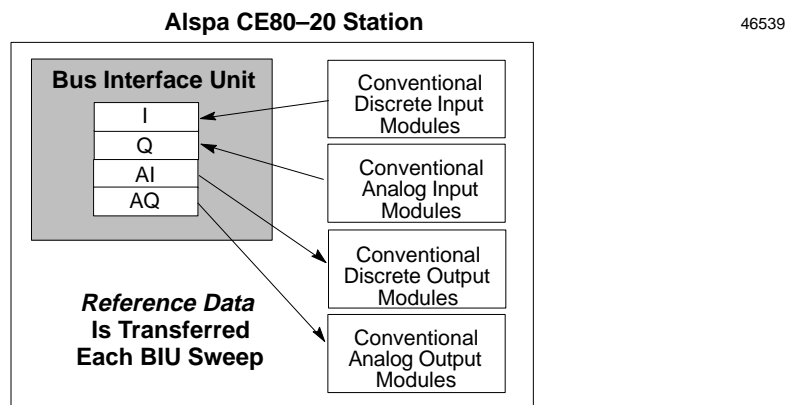

1.2. I/O Data, Status Data and Control Data for Intelligent Modules

"Intelligent" modules such as the Micro Field Processor, Thermocouple, RTD and other intelligent modules provide and receive multiple types of I/O data. (This data is sometimes called *reference parameters*). For example, the 16 Point Grouped Analog Input Module provides and receives the following types of data:

- ◆ 16 (two-byte) analog inputs for channel input data. This data is normally configured to use AI memory, although that is not required.
- ◆ 88 bits of discrete inputs (I) for module and channel status data.
- ◆ 16 bits of discrete outputs (Q) for fault-clearing commands to the module.

Some intelligent modules use all four available data types: discrete inputs and outputs and analog inputs and outputs.

The BIU reads input and status data and sends output and command data to intelligent module during every “sweep” of BIU operations.

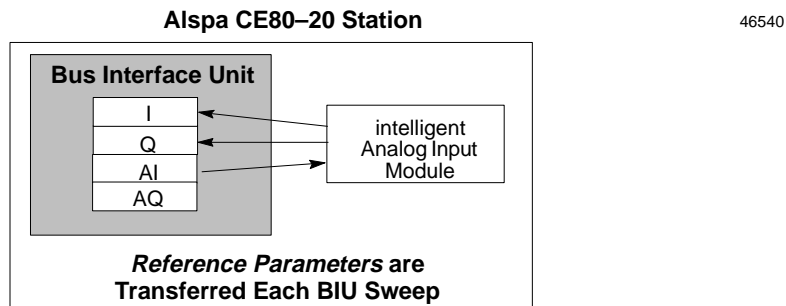

1.3. Group Data for Intelligent Modules

Intelligent modules can also be configured for “Group” data transfer with the BIU or with other intelligent devices in the same Alspa CE80–20 station. A data group is a selected set of data that the BIU transfers from one location to another location in the station. The BIU can transfer the group data during every sweep of its operations or only during specified sweeps. This ability to “skip” group data transfers during certain sweeps makes it possible to shorten the BIU’s overall sweep time.

- ◆ Up to 16 groups can be set up for an I/O station.
- ◆ A group contains data from only one module to only one module. Either module may be an I/O module, a Micro Field Processor or the Bus Interface Unit.

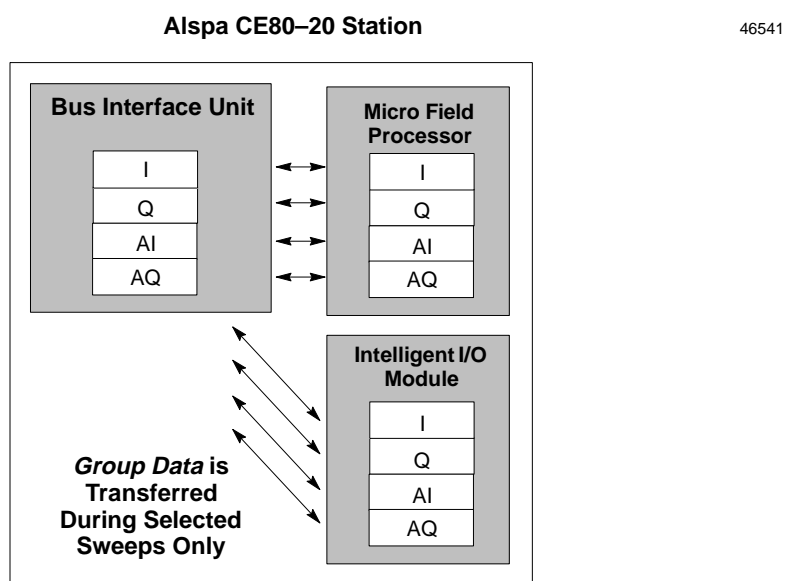

- ◆ A group can consist of a combination of I, Q, AI and/or AQ data.
- ◆ For each data type, a starting offset and length can be specified. It is not necessary to move all of a module's data.
- ◆ The data does not need to be moved during each BIU sweep.

Selective Sweep

For group data only, the BIU can move the data on each sweep or on any combination of up to 16 sweeps. The selection of sweeps is easily made when configuring the group.

Examples

Appendix D includes examples of how data might be configured for group moves.

2. THE BIU SWEEP

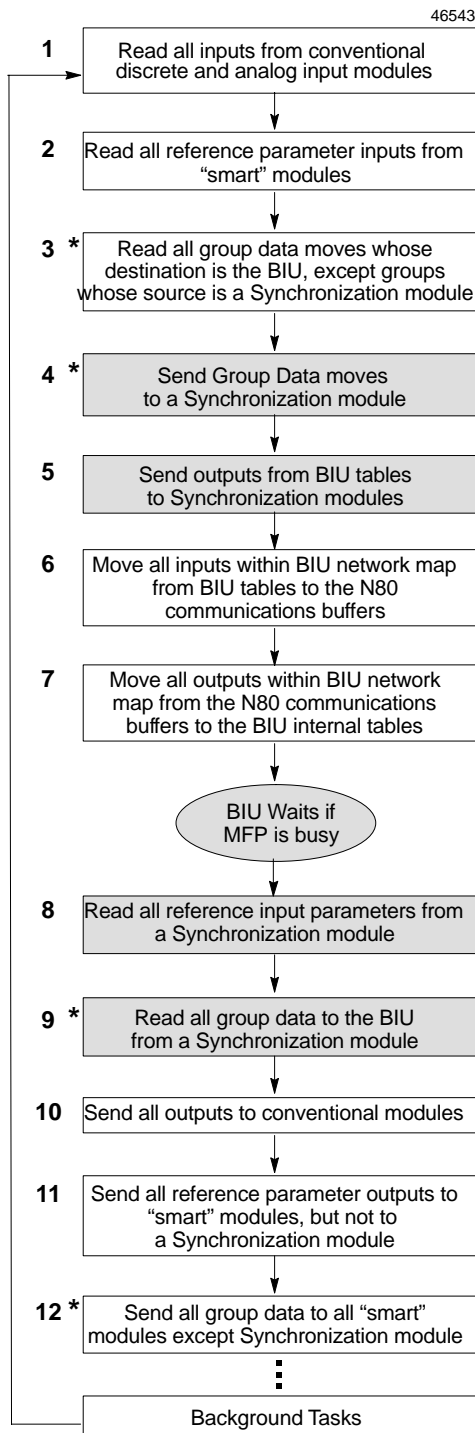

* **Group Data is moved only during its configured BIU sweeps.**

The tasks shown in shaded boxes are performed only if the I/O Station includes a Synchronization module. The Synchronization module is usually a Micro Field Processor.

The “sweep” of the Bus Interface Unit is the sequence of actions it executes repeatedly as long as the module is receiving power.

2.1. BIU Reads Inputs from Conventional Modules

The BIU first reads inputs from conventional I/O modules. The BIU combines input data with any corresponding forced data and puts it in its input data tables at the configured locations. If a module fails to supply valid input data, the BIU generates a fault report to the host. If the module is configured for Hold Last State, the BIU holds the module’s data at its last valid state. If the module is configured to default its inputs, the BIU places zeros in the module’s assigned references for all inputs that are not forced. Any forced inputs retain their forced states.

For inputs from conventional analog modules, the BIU also performs scaling, calibration, alarm checking and range checking.

2.2. BIU Reads All Input Reference Parameters

Next, the BIU reads all configured discrete and analog reference parameters from “intelligent” modules (including an MFP). If a module fails to supply valid input data, the BIU generates a fault report to the host. If the module is configured for Hold Last State, the BIU holds the module’s data at its last valid state. If the module is configured to default its inputs, the BIU places zeros in the module’s assigned references for all inputs that are not forced. Any forced inputs retain their forced states.

2.3. BIU Reads Group Data Whose Destination is BIU

Next, the BIU reads the input group data for which the destination is slot 0 (the BIU) from all intelligent modules except a Synchronization module. The BIU reads only the group inputs that have been configured to be read during that sweep. If a module fails to supply valid input data, the BIU generates a fault report to the host. If the module is configured for Hold Last State, the BIU holds the module's data at its last valid state. If the module is configured to default its inputs, the BIU places zeros in the module's assigned references for all inputs that are not forced. Any forced inputs retain their forced states.

2.4. BIU Sends Group Data to Synchronization Module

If a module (usually a Micro Field Processor) has been configured as a Synchronization module, the BIU next transfers group data assigned to be sent to it during that sweep.

2.5. BIU Sends Reference Parameters to a Synchronization Module

If a module has been configured as a Synchronization module, the BIU next sends its reference parameter data from BIU tables.

2.6. Move Input Data to the Communications Buffer

The BIU then moves all current discrete and analog input values presently in its network map into a memory buffer, in preparation for transmitting them on the N80 bus.

2.7. Move Output Data from the Communications Buffer

After moving the inputs into the communications buffer, the BIU moves newly-received output data from the communications buffer. It combines this data with any existing forced discrete output states and analog values and places the combined data in its discrete (%Q) and analog (%AQ) output memories, as defined in the BIU I/O map.

If the BIU is not receiving outputs from the bus, it sets mapped output references for conventional modules to their default/hold last state conditions, then forces them. For any intelligent module set up for defaults, the BIU sets output table references to their forced state or value, or to zero.

2.8. Move Reference Parameters from a Synchronization Module to the BIU

If a module has been configured as a Synchronization module, the BIU next moves all configured reference parameter data from the module to the BIU's internal memory tables, then applies any forces. If the Synchronization module is busy, the BIU waits then retries. If the BIU is unable to move the data after five seconds, it sets its own corresponding memory locations to zero or holds its last states, as configured for the Synchronization module.

2.9. Move Group Data from Synchronization Module to BIU

If a module has been configured as a Synchronization module, the BIU moves all its defined group data to the BIU's internal tables, then applies any forces. If the BIU is unable to read the specified data, it generates a fault report, and defaults the data to 0 or holds its last states, depending on the module's configuration. If any of the data items are presently forced, those forces are retained.

2.10. Send Outputs to Conventional Modules

The BIU next sends output data to conventional output modules in the I/O station. Discrete output modules automatically echo the received outputs back to the BIU. If a module fails to echo its outputs the BIU generates a fault report for that module. If the module is configured for output defaulting, the BIU attempts to set outputs to their default states. This is not always possible, depending on the nature of the problem.

For conventional analog modules, the BIU converts data from the selected scaled units and performs range checking before sending the outputs.

2.11. Send Reference Parameters to Intelligent Modules

Next, the BIU sends reference parameter data from its tables to intelligent modules except a Synchronization module. If the BIU is unable to contact a module it generates a fault report.

2.12. Move Group Data to Intelligent Modules

The BIU moves group data from intelligent modules or from its own internal memories to any intelligent modules, except a Synchronization module, that is configured to receive data during that sweep. If the move fails, a fault is generated.

2.13. Background Tasks

After performing all the data transfers described above, the BIU performs a sequence of background tasks such as fault processing, scanning module IDs and testing memory.

3. BIU BACKPLANE SCAN TIME

The backplane scan time for the N80 BIU depends on: the type and number of modules present in the Alspa CE80–20 station, the scan time of the Alspa N80 bus and the number and type of Group Data Move definitions.

Shorter N80 bus scan times typically impose more overhead on the BIU, increasing backplane times. Longer N80 bus scan times tend to reduce the overall load to the BIU and thus slightly decrease backplane scan times.

An estimate of backplane scan times can be found using this equation:.

$$\text{Backplane scan time (mS)} = (\text{I/O} \times (0.8 + (2.25 / \text{N80 Bus Scan}))) + \text{Groups} + \text{MFP} + 1$$

In the equation:

I/O	=	0.150 X number of conventional module discrete (I and Q) bytes
	+	0.500 X number of conventional module analog (AI and AQ) words
	+	0.090 X number of intelligent module discrete (I and Q) bytes
	+	0.150 X number of intelligent module analog (AI and AQ) words
	+	0.500 X number of I/O modules
Groups	=	0.015 X number of bytes, internal BIU table moves
	+	0.093 X number of bytes, BIU / module moves
	+	0.175 X number of bytes, module to module moves
MFP	=	MFP logic sweep time (if MFP synchronized)

Example 1:

Four modules, no Group Data Moves. N80 bus speed is 47ms.

Slot	Module	Data per Module	Time per word / byte	Total Time in ms
1	16-Point Grouped Analog Input Module (IC670ALG240)	16 words AI 11 bytes I 2 bytes Q	0.150 0.090 0.090	2.40 0.99 0.18
2	Conventional discrete output module	2 bytes Q	0.150	0.30
3	Conventional analog output module	4 words AQ	0.500	2.00
4	RTD Input module	4 words AI 4 bytes I 1 byte Q 4 words AQ	0.150 0.090 0.090 0.150	0.60 0.36 0.09 0.30
+	number of modules (4)		0.500	2.00
=	Total I/O			9.52
	$9.52 \times (0.8 \times (2.25 / 47 \text{ ms}))$			8.07 ms
+	Groups (none)			0.00
+	Micro Field Processor (none)			0.00
+				1.00
	Estimated backplane scan time			9.07 ms

Example 2:

Five modules, one Group Data Move. Alspa N80 bus speed is 26 ms.

Slot	Module	Data per Module	Time per word / byte	Total Time in ms
1	Conventional analog output module	4 words AQ	0.500	2.00
2	Conventional analog input module	8 words AI	0.500	4.00
3	Conventional discrete output module	2 bytes Q	0.150	0.30
4	Conventional discrete input module	2 bytes I	0.150	0.30
5	16-Point Grouped Analog Input Module (IC670ALG240)	16 words AI	0.150	2.40
		11 bytes I	0.090	0.99
		2 bytes Q	0.090	0.18
+	number of modules (5)		0.500	2.50
=	Total I/O			12.67
12.67 X (0.8 X (2.25 / 26 ms))				11.23 ms
+	Groups	64 bytes: Internal BIU table move		0.96
+	Micro Field Processor (none)			0.00
+				1.00
Estimated backplane scan time				13.19 ms

4. DATA TRANSFER BETWEEN THE BIU AND THE HOST

Each bus scan, a Bus Interface Unit exchanges the following data with the host:

- ◆ It sends an input message with up to 128 bytes of discrete and/or analog inputs.
- ◆ It receives an output message with up to 128 bytes of discrete and/or analog outputs.

The exact length of these messages is determined by the network I/O map configured for the Bus Interface Unit.

4.1. Data in the BIU's Network (Bus) Map

As mentioned previously, the BIU has 256 bytes of memory available for each of the four types of data (discrete and analog inputs and outputs: I, Q, AI and AQ). For each data type, up to half (128) of the 256 bytes can be used for the data that will be exchanged on the N80 bus. During BIU configuration, starting addresses and lengths are set up for each of the BIU's four types of I/O memory. These addresses and lengths define the BIU's network I/O map. The data from each table (I, AI, Q and AQ) must be contiguous.

BIU Memory Type Designation	Amount Available in BIU	Maximum Length for Network Map
I	256 bytes	up to 1024 contiguous bits
Q	256 bytes	up to 1024 contiguous bits
AI	256 bytes	up to 64 contiguous words
AQ	256 bytes	up to 64 contiguous words

Note that although it is possible to configure up to 128 bytes of memory in the network map for each data type, the maximum amount that can be included in the map is a total of 128 bytes of inputs (I plus AI) and 128 bytes of outputs (Q plus AQ).

Data to be exchanged on the bus must be configured to use references within the network map configured for the BIU. Data of individual I/O modules may be configured anywhere within available memory. It is possible to have inputs or outputs within the I/O station that are not exchanged on the N80 bus—that is, data that is completely local to the I/O station. For example, the I/O station might include a Micro Field Processor performing local data processing.

4.2. Communications on the N80 Bus

After a Bus Interface Unit completes a successful login with the host, it begins sending input data on the bus and accepting output data from the bus. The BIU communicates on the bus repetitively and asynchronously. When the BIU receives the N80 bus communications token, it sends the most recent data from the configured portion of its I and AI memories on the bus. As mentioned, these memories are repeatedly updated whenever the Bus Interface Unit scans the input modules in the station.

The Bus Interface Unit receives new outputs from the host when the host's bus controller has the communications token. It places these outputs into the configured portion of its Q and AQ output tables. These outputs are then passed to the devices in the station on the BIU's next I/O scan.

4.3. Input Data Sent by the Bus Interface Unit

When the Bus Interface Unit takes its turn on the bus, it sends one input data message containing the latest values for all configured discrete inputs followed by all configured analog inputs. Because they are broadcast (like all N80 inputs), they can be obtained by any Bus Controller on the bus.

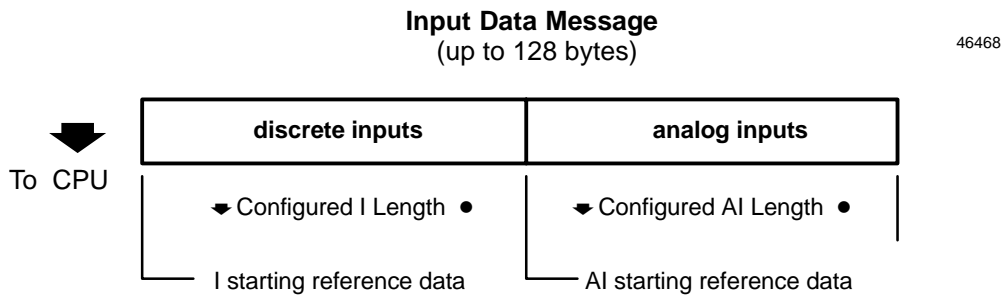

The data lengths are equal to the configured lengths of I and AI data selected for the Bus Interface Unit (regardless of the host CPU type or the actual amount of output data needed for the modules physically present in the station). Either length may be zero.

The discrete inputs appear in the input message in the same sequence as their assigned input references. Each discrete input module occupies one byte per eight circuits.

The analog inputs are also in the same sequence as their assigned input references. Each analog input module occupies two bytes (one word) for each analog channel.

The Bus Interface Unit sends this data from its internal I and AI memories, beginning at the start locations selected during station configuration.

4.3.1. Input Defaults

When configuring input modules, either a default state or hold last state can be selected. If an input module is removed or fails to operate correctly, the chosen state is substituted for actual input data. A diagnostic message is provided to indicate loss of module. Forced input data is not affected.

4.3.2. I/O Data Handling by Host

How the host handles input data from the Bus Interface Unit depends on the host type:

- ◆ An Alspa C80–75 PLC places the data in the %I and %AI references selected during PLC configuration. These must be the same references selected during Bus Interface Unit configuration.
- ◆ A host computer with a PCIM module places the data into the input table segment that corresponds to the serial bus address (Device Number) of the Bus Interface Unit.

4.4. Outputs from the Host to the BIU

Each time the host’s Bus Controller has the bus communications token, it sends any outputs it has received from the CPU to the devices on the bus. Outputs for the Bus Interface Unit are sent in one output data message, with all configured discrete outputs followed by all configured analog outputs.

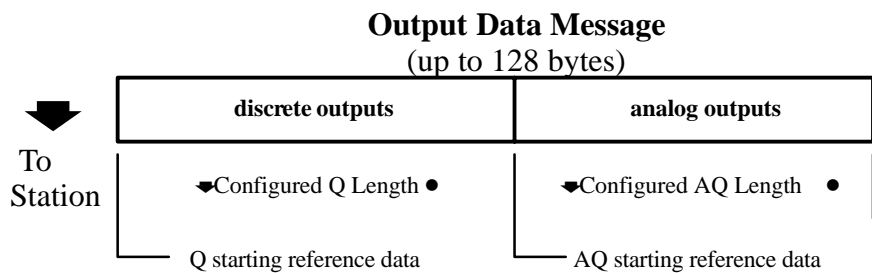

The data lengths are equal to the configured lengths of Q and AQ data selected for the Bus Interface Unit (regardless of the host CPU type or the actual amount of output data needed for the modules physically present in the station). Either length may be zero.

4.4.1. Output Data Format

The output data format shown above is required by the BIU.

When generating the output data message, an Alspa C80–75 Bus Controller automatically places the Q data ahead of the AQ data. Other types of host must send an output message consisting of the correct number of bytes of discrete output data followed by the correct number of bytes of analog output data.

As soon as new output data is received, the Bus Interface Unit checks it to be sure the data is error-free and of the correct length. The length must match the combined lengths of the discrete output data and analog output data that have been configured for the Bus Interface Unit’s network I/O map. After verifying the accuracy of the data, the Bus Interface Unit puts the data in its Q and Q tables and begins passing it to the output modules in the station. Each discrete output module receives one byte of data for each eight circuits. Each analog output module receives two bytes (one word) for each analog channel.

4.4.2. Output Defaults

On powerup, all outputs go to their programmed default state, except outputs which had previously been forced—they go immediately to their forced state or value.

If CPU communications are lost for 3 bus scans, all outputs that are not presently forced will either default or hold their last state, as configured.

Conventional I/O modules can have a configured output default value. Intelligent modules default outputs are always zero.

5. N80 BUS SCAN TIME

The N80 bus scan time is dependent on the number of devices and amount of data traffic on the bus. The bus scan time may vary from 3–400 ms, but 20–30 ms is typical. Bus Controllers impose a minimum N80 bus scan time of 3 ms. Therefore, N80 bus scan time can never be less than 3 ms.

The bus scan time contribution for Alspa CE80–20 station depends on its I/O data usage. The table below shows the scan time contribution, at each baud rate, for stations with a total of 16, 32, 64, 128 and 256 bytes, when the Bus Interface Unit receives outputs from *only one bus controller at a time*.

To find the exact scan time contribution for a station, follow the procedure below.

Total Amount of Input and Output Data for Alspa CE80–20 Station	Contribution time in ms at each baud rate			
	153.6 Kb std	153.6 Kb ext	76.8 Kb	38.4 Kb
16 bytes	2.09	2.16	3.83	7.16
32 bytes	3.24	3.31	6.12	11.74
64 bytes	5.52	5.60	10.69	20.89
128 bytes	10.10	10.17	19.85	39.20
256 bytes (fully-loaded)	19.25	19.32	38.15	75.80

Table 4.1– Alspa CE80–20 contribution to N80 scan time

5.1. Procedure for Estimating Bus Scan Time for an Alspa CE80–20 Station

1. Find the total number of input bytes and output bytes. (Each analog channel is 2 bytes. Eight discrete points are one byte).

number of input bytes = _____

number of output bytes = _____

total bytes = _____

2. With this total, calculate a scan time contribution using the formula below that corresponds to the N80 bus baud rate.

Formula for 153.6 Kbaud Standard:

$$0.943\text{ms} + (0.0715 \times \text{total bytes}) = \text{_____ ms}$$

Formula for 153.6 Kbaud Extended:

$$1.015\text{ms} + (0.0715 \times \text{total bytes}) = \text{_____ ms}$$

Formula for 76.8 Kbaud:

$$1.538\text{ms} + (0.143 \times \text{total bytes}) = \text{_____ ms}$$

Formula for 38.4 Kbaud:

$$2.583\text{ms} + (0.286 \times \text{total bytes}) = \text{_____ ms}$$

Other devices on the bus, including the Bus Controller, Hand-Held Monitor and I/O blocks also add to the bus scan time. The *ALS 52301 Alspa CE80-15 I/O System and Alspa N80 Communications Network User's Manual* shows how to calculate overall bus scan time for all of the devices on a bus. Remember that the N80 bus scan time can never be less than the 3 ms minimum enforced by the bus controller.

5.2. Throughput

If an output in the station is tied to an input in the same station, the output changes state (or value, in the case of an analog output module) within a few milliseconds of the new output being sent from the bus controller to the Bus Interface Unit. (To guarantee that an output changes state, that state must be present for at least one BIU sweep time or bus scan time, whichever is greater).

The input which is tied to the output responds as soon as any load-effects have settled out and input filtering is completed. This may occur as soon as the Bus Interface Unit's next I/O scan.

If the host is a PLC, an input must be present for at least one PLC sweep time plus one N80 bus scan time plus one BIU sweep time to guarantee its detection by the PLC. If the input changes state only briefly and then changes again before the input data is sent on the bus, the interim state may be overwritten in the Bus Interface Unit's internal memory by some new input state or value before it can be sent.

6. OPERATION OF THE BIU WITH A MICRO FIELD PROCESSOR

The Micro Field Processor (MFP) is a specialized Micro PLC that provides local input/output logic within an Alspa CE80–20 I/O station. The MFP itself does not perform an I/O scan; that function is performed by the BIU.

6.1. MFP and BIU Synchronization

Automatic operation of the Micro Field Processor must be synchronized with that of the BIU.

Synchronization between the MFP and the BIU occurs at the following points:

1. The MFP waits for group data from the BIU.
2. The MFP waits for its input reference parameter data from the BIU. After receiving the reference parameter data from the BIU, the MFP solves its logic program.
3. After solving its logic program, the MFP waits for the BIU to request its output reference parameter data. Or, if the MFP is still busy, the BIU waits for the Micro Field Processor to finish solving its logic.
4. The MFP waits for the BIU to request any group data from the MFP.

The diagram on the next page shows the basic points of synchronization between a BIU and an MFP. The Micro Field Processor always performs housekeeping and programmer window functions regardless of the combination of BIU and MFP modes.

6.2. MFP I/O References

The MFP itself has the following configurable references:

I001	to	I512
Q001	to	Q512
AI001	to	AI128
AQ001	to	AQ128

References used by the host may map to these MFP references, although that is not necessary. Appendix D gives examples of I/O reference assignments.

6.3. MFP Operating Modes

In the **Standard Program Sweep** mode, the Micro Field Processor executes each sweep as quickly as possible with a varying amount of time consumed each sweep.

In the **Constant Sweep Time** mode, each sweep consumes the same amount of time. This time is configurable to be from 5 to 200 milliseconds.

When the MFP is in **Stop** mode, the application program is not executed. In this mode, it is possible to choose whether or not the I/O is scanned (internally, by the MFP) and whether communications with the programmer will continue.

If the BIU requests data from the Micro Field Processor while the MFP is in Stop Fault mode, the requested data will either be defaulted or held in its last state, depending on the configuration of the MFP.

In Stop–No I/O mode, the MFP updates its internal I/AI tables with data received from the BIU and sends zeros for all data (reference or group) to the BIU.

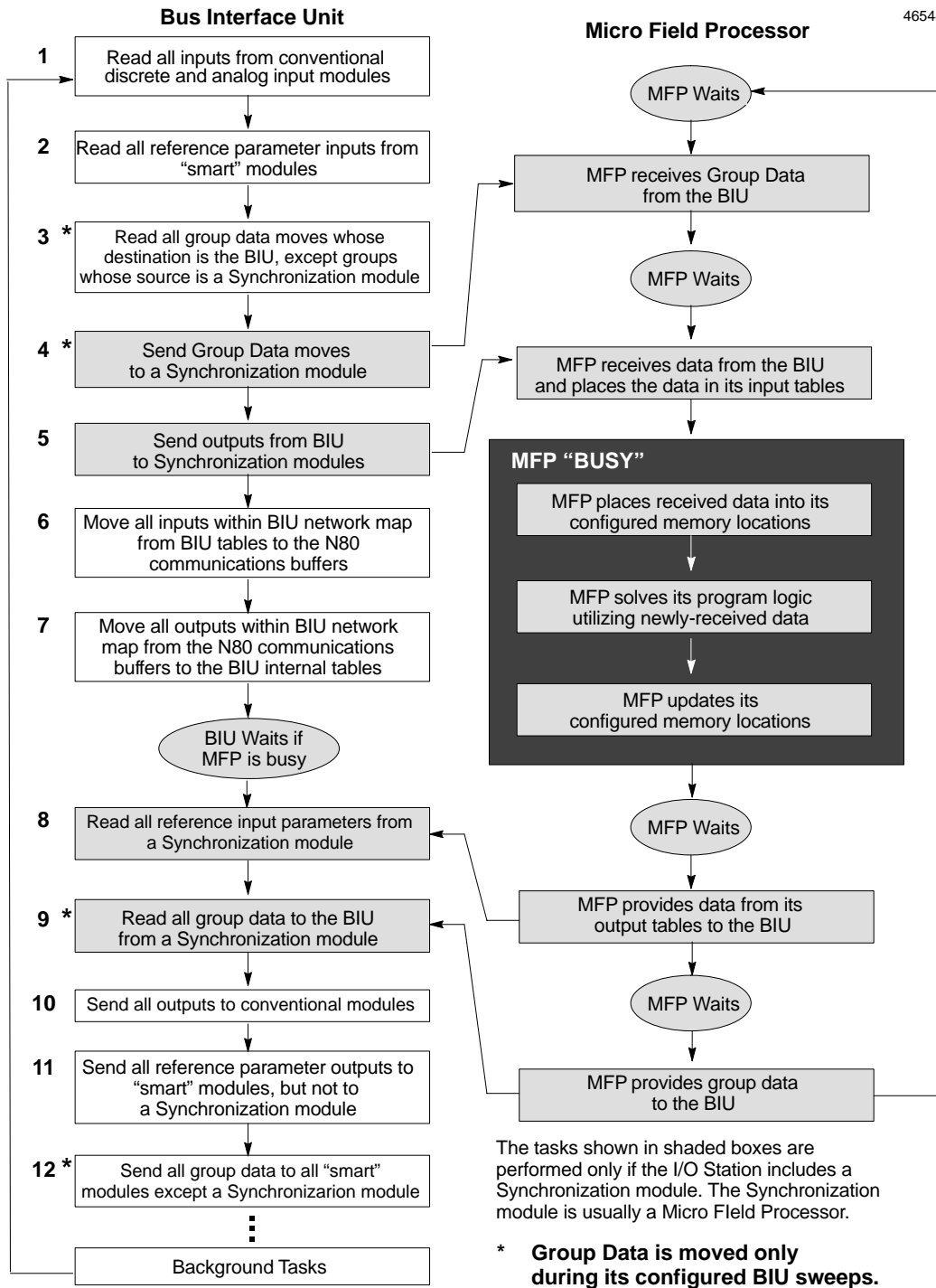
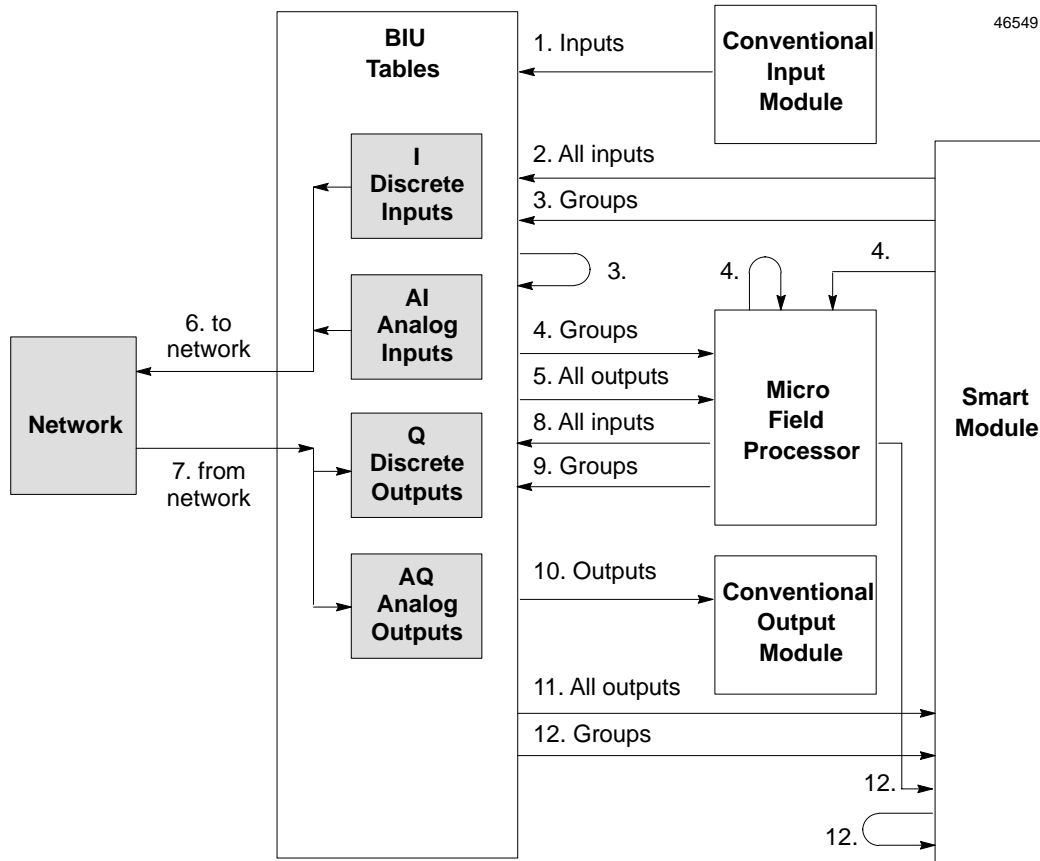

Figure 4.1 – Synchronous Operation of a BIU and a Micro Field Processor

6.4. Overview of Synchronous Operation

The following diagram and table show how data is handled during synchronous operation.



Sweep Step	Action	Forces, if mapped?	No Network?	Cannot Read Module?
1	Inputs from conventional modules	yes	—	defaults
2	All inputs from intelligent modules	yes	—	defaults
3	Groups not from MFP: to BIU tables	yes	—	defaults
4	Groups to MFP	yes	—	—
5	All outputs to MFP (starts solution)	—	—	—
6	Move to network	—	n/a	n/a
7	Move from network	yes	n/a	n/a
8	All inputs from MFP (gets solution)	yes	—	defaults
9	Groups from MFP to BIU tables	yes	—	defaults
10	Outputs to conventional modules	—	defaults at step 7	—
11	All outputs to intelligent modules	—	defaults at step 7	—
12	Groups to intelligent modules	—	defaults at step 7	defaults
(13)	Data displayed on HHM	—	—	—

7. BACKING UP MICRO FIELD PROCESSOR OUTPUTS

The network can back up outputs normally controlled by the Micro Field Processor if the MFP fails or goes into Stop Faulted mode.

To create this backup capability for one or more output modules, do the following:

1. Configure the module outputs to lie within *both* the BIU's Network Map and the MFP's I/O map.

For example:

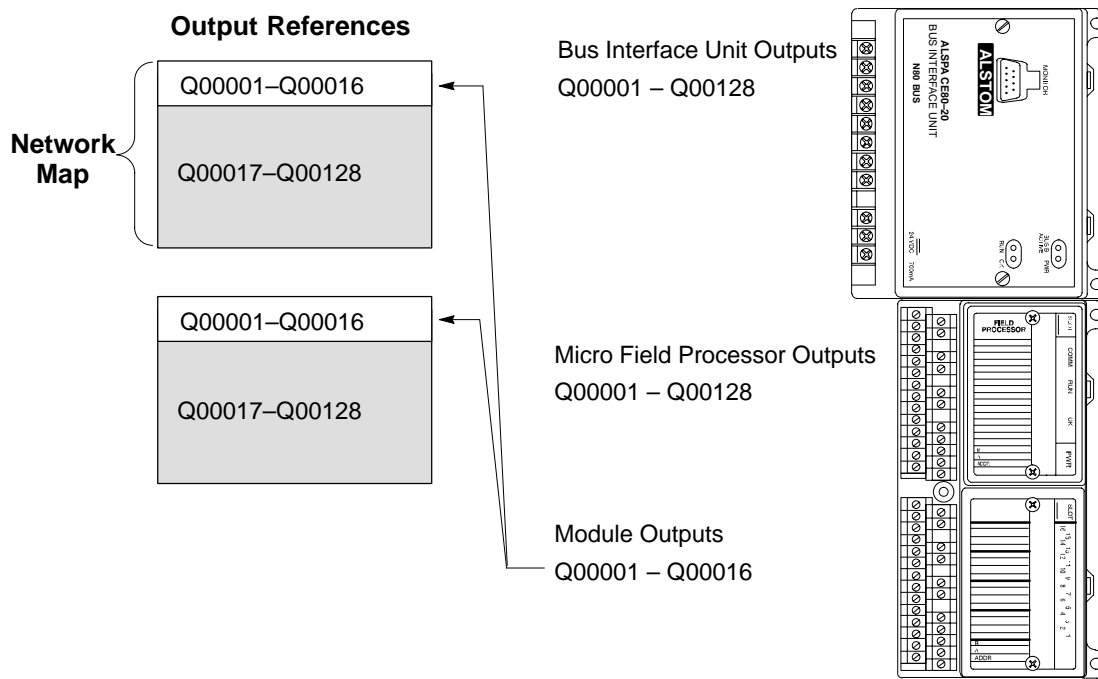

2. Configure Hold Last State (not Default) for the MFP output table.

8. HOW THE NETWORK BACKS UP MFP OUTPUTS

This technique works because of the synchronization between the operations of the Bus Interface Unit and the Micro Field Processor. The diagram below shows details of the BIU/MFP synchronization process. The numbers on the left side are the same as the numbers on the synchronization diagram.

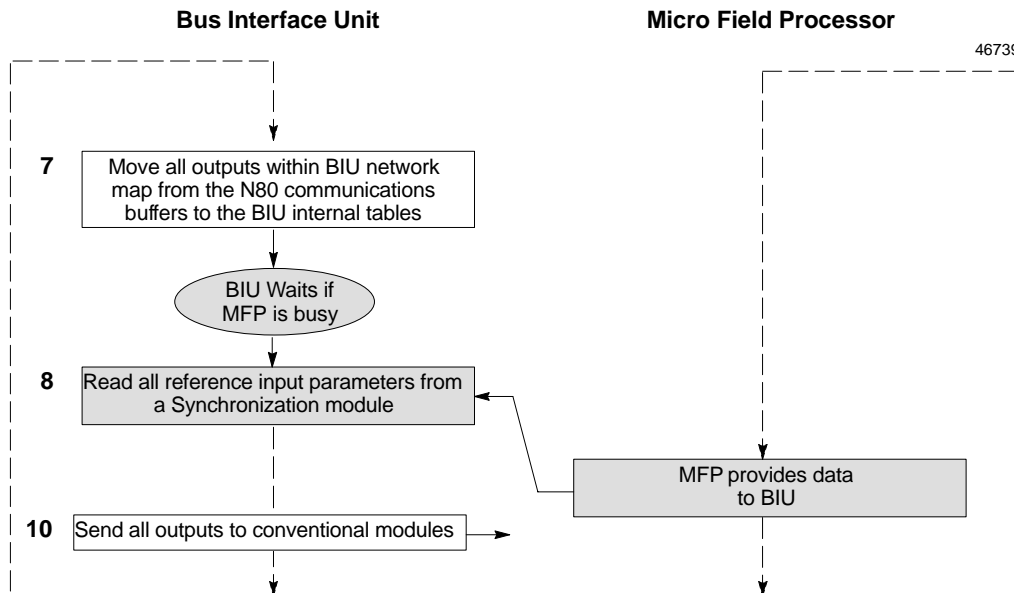

The Bus Interface Unit receives output data for the backed-up output module(s) from the N80 bus (step 7). In step 8, the BIU receives data from the Micro Field Processor. Any data with the same reference assignments overwrites the data already received from the bus. When the BIU sends outputs to I/O modules (step 10), it sends the most recent contents of the output references. If the MFP has not provided fresh output data (for example, if the MFP has stopped communicating with the BIU), the outputs from the network are sent to the modules instead. Note that this will not work if MFP outputs are configured to default instead of Hold Last State, because selecting default causes the BIU to write default values into the output references at step 8.

9. BACKING UP BIU OUTPUTS WITH A MICRO FIELD PROCESSOR

The Micro Field Processor can take over control of outputs normally provided from the network by the Bus Interface Unit, if those outputs become unavailable. This technique requires the addition of ladder logic to the application program.

To create this backup capability for one or more modules, do the following:

1. Configure the module outputs to the Bus Interface Unit *outside* of the BIU's network map (that is, the data exchanged with the bus), but *within* the I/O range of the MFP.

For example:

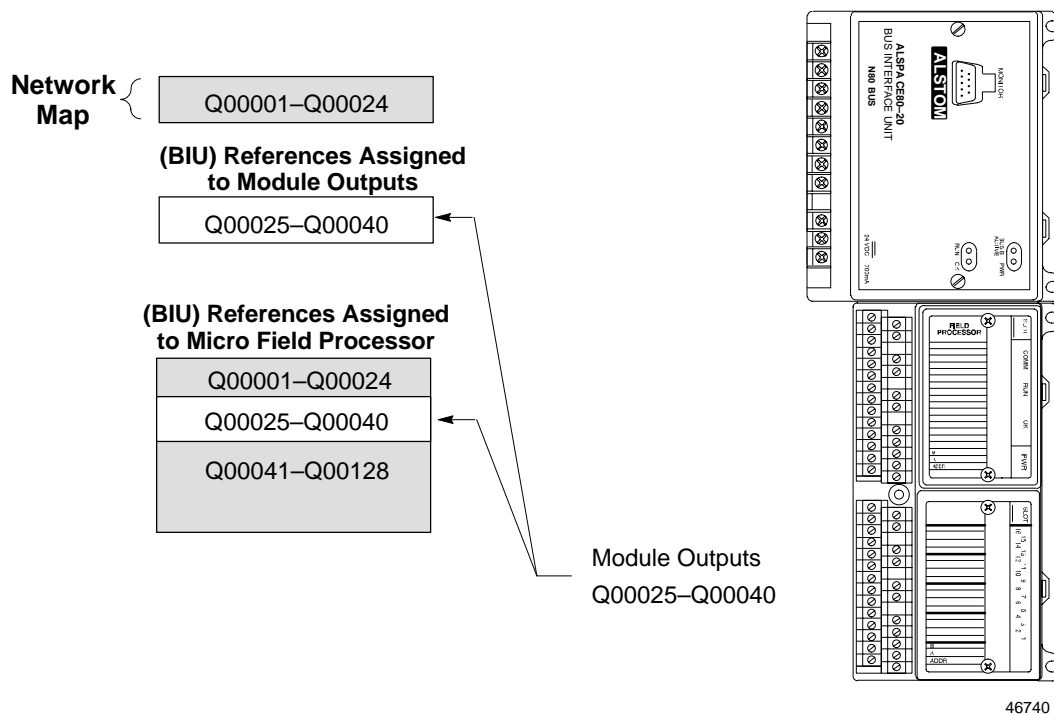

2. Create variables to monitor the presence of network outputs, BIU outputs and to serve as a heartbeat to verify the presence of the network.

For the example, the variables are:

VARIABLE DECLARATION TABLE

<u>REFERENCE</u>	<u>NICKNAME</u>	<u>REFERENCE DESCRIPTION</u>
I00001	NETOUTS	Network Outputs
I00017	NETPRES	Network presence status
Q00001	STOUTS	Station outputs

3. Add ladder logic like the following example to the application program.

Chapter 5

Station Configuration

This chapter explains how to configure a Bus Interface Unit and the I/O modules in a station using a Hand-Held Monitor. HHM version 4.6 (IC661HHM502) or later is required. Note that the BIU and I/O modules can also be configured via datagrams from the host. Datagram formats are detailed in chapter 8.

- Configure the serial bus address and baud rate,
- Set Up the Hand-Held Monitor,
- Create a New Configuration,
- Configure the Bus Interface Unit,
- Configure Alspa CE80–20 modules,
- Configure the Network Map for the Bus Interface Unit,
- Add Modules and Assign References,
- Configure a discrete input module,
- Configure a discrete output module,
- Configure a discrete inout/output module,
- Configure a conventional analog input module,
- Configure a conventional analog output module,
- Configure a 16–point grouped analog input module,
- Configure an 8–point grouped analog voltage input module,
- Configure a 16–point grouped analog voltage input module,
- Configure an RTD input module,
- Configure a thermocouple input module,
- Configure an 8–point analog voltage output module,
- Configure an 8–point analog current output module,
- Configure a micro field processor.

For Additional Information, Also See:

The *ALS 52211 Alspa CE80–15 Hand–Held Monitor User’s Guide* for basic operating instructions.

The programming/set–up instructions for the system host. The instructions in this chapter are for local configuration of the BIU and the modules in the I/O station. The system host must also be configured appropriately to exchange information with the BIU. If the host is an Alspa C80–75 PLC, with Alspa P8 software release 5.0 or earlier the Alspa N80 Bus Interface Unit must be configured as a “Generic I/O” device.

1. CONFIGURE THE SERIAL BUS ADDRESS AND BAUD RATE

Before a Bus Interface Unit can communicate on the N80, its serial bus address must be configured. That means if you install a Bus Interface Unit and power it up BEFORE configuring its serial bus address, it does not communicate on the bus. When you subsequently configure the serial bus address, the Bus Interface Unit begins communicating on the bus immediately. The baud rate must be set first in order to configure the BIU online. See the instructions for setting on the Hand-Held Monitor on the next page.

Special Instructions for Alspa C80–75 PLC Systems

However, assigning the serial bus address is the first configuration step, prior to assignment of the network map for the Bus Interface Unit. So when the Bus Interface Unit starts communicating, its I/O map has not yet been assigned. If the Alspa C80–75 is the host, that causes it to generate CONFIGURATION MISMATCH faults. One such fault appears for each non-matching data type and length. Depending on the PLC's own configuration, CONFIGURATION MISMATCH faults may be either diagnostic only or "fatal" (shutting down the system).

To avoid problems, you can do either of the following (method A is preferred):

- A. Check the PLC configuration to determine whether CONFIGURATION MISMATCH is set up as a fatal fault. If it is, powering up the bus and Bus Interface Unit then assigning a serial bus address will cause a fatal error and shut down the PLC.
 - if CONFIGURATION MISMATCH is a diagnostic fault, you can install the Bus Interface Unit on the bus and power it up before configuring its serial bus address.

The Bus Interface Unit will start communicating immediately, generating CONFIGURATION MISMATCH faults. Complete the configuration, ignoring the faults temporarily. When you complete the Bus Interface Unit configuration, the Bus Interface Unit drops off the bus briefly, generating a LOSS OF DEVICE fault. When it returns, an ADDITION OF DEVICE diagnostic appears. If no new mismatch faults occur after the Bus Interface Unit comes back on the bus (check the timestamp on the faults), the I/O maps match in the PLC and in the Bus Interface Unit.
 - if CONFIGURATION MISMATCH is a fatal fault, configure the Bus Interface Unit's serial bus address and I/O map offline, *before installing the Bus Interface Unit*. HHM setup instructions for offline configuration are on the next page. When you then install and power up the Bus Interface Unit, CONFIGURATION MISMATCH faults will not be generated. You can complete the rest of the configuration after installation and power-up, if you prefer.
- B. Take the BIU off the bus prior to configuring the Bus Interface Unit. Configure the Bus Interface Unit baud rate, serial bus address and network map while the BIU is off the bus.

2. SET UP THE HAND-HELD MONITOR

1. **If the Bus Interface Unit is connected to an operating bus, the Hand-Held Monitor must be the ONLY Hand-Held Monitor plugged into any device on the bus.**

If the Bus Interface Unit is NOT presently connected to a properly-terminated N80 network, install a 75Ω terminating resistor across the Main Bus Serial 1 and Serial 2 terminals on the Bus Interface Unit Terminal Block. The resistor is needed only for off-line communications between the HHM and the Bus Interface Unit; it should be removed prior to bus installation (unless the BIU Terminal Block is the last device on the bus).

2. **Begin with the HHM turned off. Attach it to the connector on the Bus Interface Unit.**

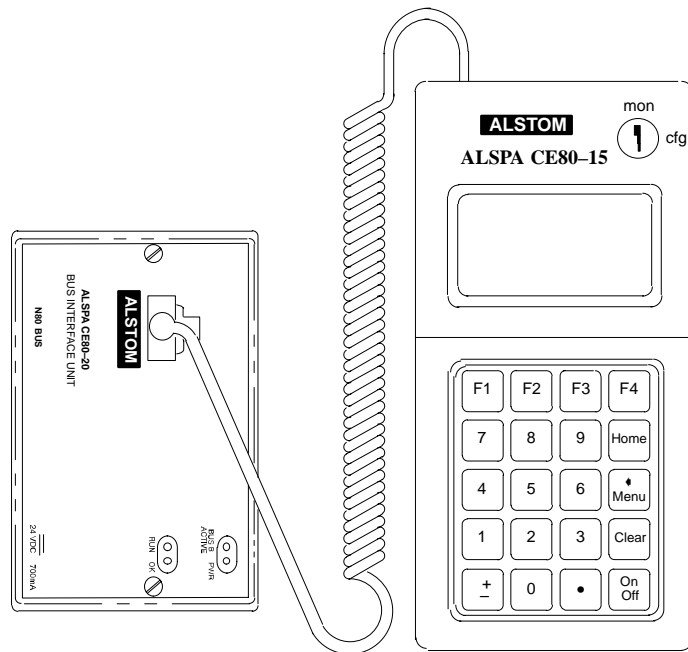

46475

Figure 5.1 – Hand-Held Monitor–BIU connection

3. **Turn the Hand-Held Monitor on. Adjust its baud rate if necessary.**

Previously unconfigured factory-shipped modules operate at 153.6 Kbaud standard. You should be aware of the operating baud rate before trying to communicate with the Bus Interface Unit and the Hand-Held Monitor’s baud rate should be set correspondingly. After HHM power-up and setup, the Home menu appears.

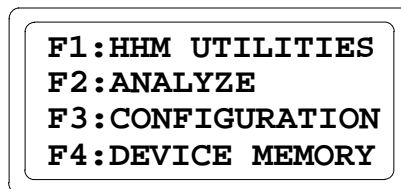

If the message **FUNCTION DISABLED** appears during configuration, the corresponding HHM option has been disabled. To continue, it will be necessary to change HHM options in the HHM Utilities menu. If the message **CONFIG PROTECTED** appears, the Bus Interface Unit configuration has been protected. To continue, it will be necessary to “unprotect” the configuration.

3. CREATE A NEW CONFIGURATION

If the Bus Interface Unit has already had its Serial Bus Address configured, go to the instructions on the next page.

If the Bus Interface Unit has not been assigned a Serial Bus Address, select F3 (Configuration) from the previous menu. The configuration Main Menu appears:

```

F1:PROG BLOCK ID
F2:CONFIG BLOCK
F3:COPY CONFIG
F4:

```

Select Program Block ID (F1).

Assigning a Serial Bus Address to a New BIU

The first step in configuring a new Bus Interface Unit is to assign its Serial Bus Address (block number) on the Program Block ID screen. There are 32 available addresses (from 0 to 31) on a bus. One is needed for the Hand-held Monitor; typically, this is 0. Another is needed for the Bus Controller. Typically, this is 31 (30 or 31 for redundancy systems). A Bus Interface Unit is usually assigned a Serial Bus Address from 1 to 29 or 30. Duplicate Serial Bus Addresses disrupt communications and are not permitted.

```

PROG BLOCK ID
I/O      ?-   ??
BLOCK NO.  ?
ref blk      nxt

```

1. Press F2 (Block). Then, enter the Device Number (1-30). For example:

```

PROG BLOCK ID
I/O      ?-   ??
BLOCK NO. 14
      blk      nxt

```

If you make a mistake, press F2 again, then enter the correct number.

2. If you are configuring the Bus Interface Unit on an operating bus, when you press the F3 (Enter) key, an error message appears if the number has been used for another device. If the Bus Interface Unit is not online, be sure to assign a unique Serial Bus Address or there will be a conflict when the Bus Interface Unit is powered up on the bus.
3. Press the Home key to return to the HHM's Main Menu. The message **Please Wait** appears.

4. CONFIGURE THE BUS INTERFACE UNIT

From the HHM's Main Menu:

```
F1:HHM UTILITIES
F2:ANALYZE
F3:CONFIGURATION
F4:DEVICE MEMORY
```

Press F2 twice to display the HHM's special set of menus for the Bus Interface Unit. (To display these menus, a serial bus address must have been configured for the Bus Interface Unit on the Program Block ID screen). An overview of these menus is shown on the next page.

This is the HHM's Main Menu for the Alspa CE80-20:

```
F1 Monitor
F2 Configuration
```

From this menu, press F2 (Configuration). This menu appears:

```
F1 N80 CONFIG
F2 Module Config

F3 Previous Menu
```

From this menu, you can:

- Press F1 to configure the N80 Bus Interface Unit. Instructions begin on the page 5-8.
- Press F2 to configure the individual modules in the station. Instructions begin on page 5-21
- Press F4 to display the next configuration screen:

```
F1 Grp Data Move
F2 Previous Menu

More
```

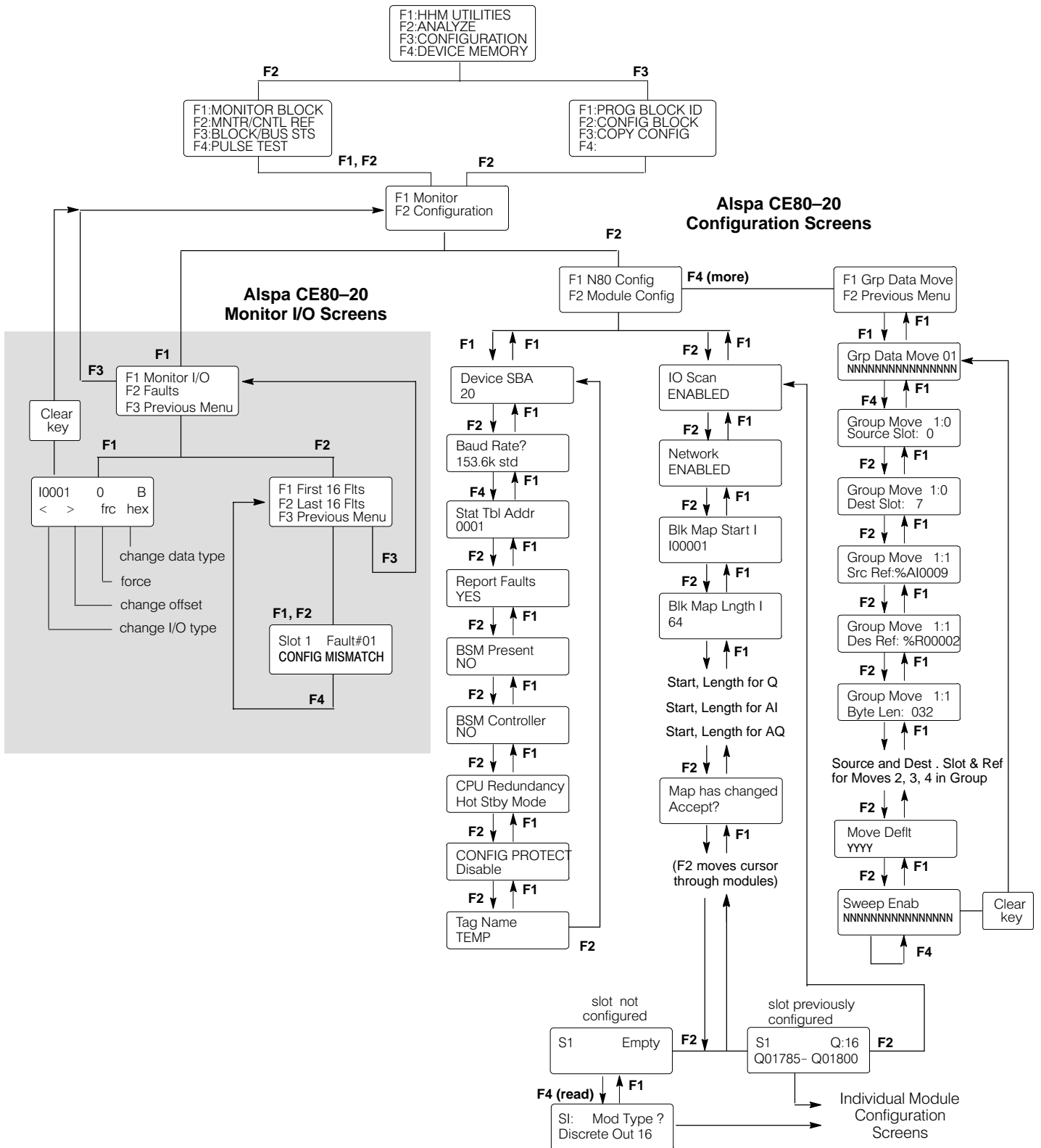

Alspa CE80–20 HHM Menu Overview



4.1. Change the Serial Bus Address of the Bus Interface Unit

For a new BIU, the Serial Bus Address is assigned on the Program Block ID screen, as described previously. If you want to change the Serial Bus Address of a previously-configured BIU, use the Device SBA screen shown below, instead.

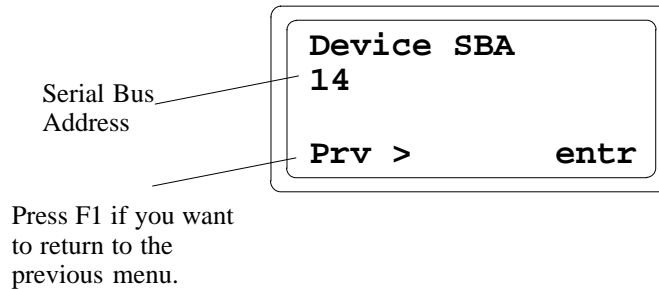
When you press F1 (N80 Configuration) from the Configuration menu, the following screen appears:



On this screen, you can change a previously-configured Serial Bus Address (block number). There are 32 available addresses (from 0 to 31) on a bus. One is needed for the Hand-Held Monitor; typically this is Device Number 0. Another is needed for the Bus Controller. Typically, this is 31 (30 or 31 for redundancy systems). A Bus Interface Unit is usually assigned a Serial Bus Address from 1 to 29 or 30. Duplicate SBAs disrupt communications and are not permitted.

Note

If a Bus Interface Unit has a Serial Bus Address conflict on an operating bus, it will not scan the modules in the station until the fault is cleared.

1. Enter a Serial Bus Address using the HHM keypad.
2. Press the F4 (entr) key. An error message appears if the number has been used for another device on the bus.
If you want to go to the next screen without changing the Serial Bus Address, press F2 (>).

4.2. Select the Baud Rate

N80 bus communications can occur at any of four baud rates: 153.6 Kbaud standard, 153.6 Kbaud extended, 76.8 Kbaud or 38.4 Kbaud. The default is 153.6 K baud standard. The *ALS 52301 Alspa CE80–15 I/O System and Alspa N80 Communications Network User's Manual* gives guidelines for baud rate selection.

Each device's communications baud rate must be the same as that used by all other devices on the bus or the bus will not operate.

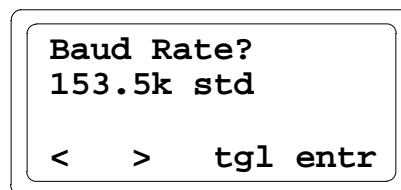

If you want to go to the next screen without changing the baud rate, press F2 (>).

2. If the baud rate should be changed, press F3 (toggle) to display the other baud rate choices.

The asterisk means a choice now being displayed has been changed by pressing the F3 (tgl) key.

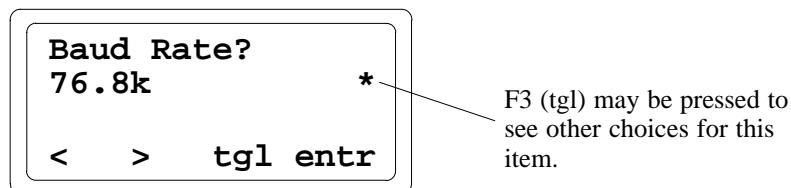

3. When the desired baud rate appears, press F4 (enter). On this screen (only) the asterisk will remain until you power-cycle the Bus Interface Unit to implement the new baud rate.

Note

If the baud rate is changed on any block that is currently installed on an operating bus, it must be changed on all devices on that bus. After changing the baud rate, you must cycle power at the same time to all devices on the bus to use the new baud rate.

4.3. Configure Fault Reporting

On the next screen, select whether or not the Bus Interface Unit will perform any fault reporting.

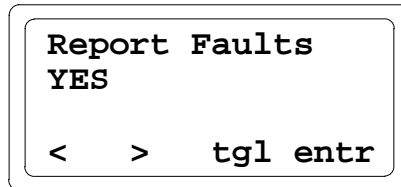

If you want to set up partial fault reporting for the station, you can set fault reporting to YES here but inhibit fault reporting for some or all individual modules in the station. Instructions for setting up or inhibiting fault reporting for individual modules are included in the module configuration portion of this chapter.

If you want to go to the next screen without making a change, press F2 (>).

If the Report Faults selection should be changed, press F3 (tgl).

2. Press F4 (entr) to save the change and go to the next menu.

4.4. Configure N80 Network Redundancy

If the Bus Interface Unit will be used as a bus switching device itself or located on a bus stub downstream of another device that acts as a bus switching device, BSM Present should be set to YES. For all other applications, set it to NO.

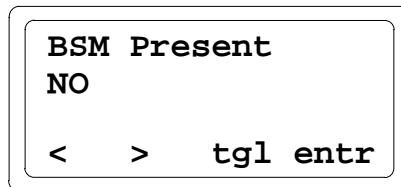

If you want to go to the next screen without making a change, press F2 (>).

If the selection should be changed, press F3 (tgl).

2. Press F4 (entr).

- If you selected NO, go to the next page.
- If you selected YES, the following screen appears:

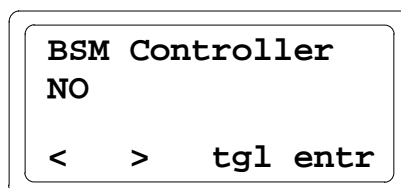

3. If the Bus Interface Unit will be used as the bus switching device itself, set BSM Controller to YES. For all other applications, set it to NO.

Next, the Output Default Time screen appears:

```

Out Def Time
2.5 sec
< > tgl entr

```

4. If the total bus scan time is expected to exceed 100 mS, set the Output Default Time to 10 seconds. The Output Default Time is normally 2.5 seconds. If the Bus Interface Unit stops receiving outputs from the Bus Controller, it will wait for this specified time period before defaulting outputs in the station.

If you want to go to the next screen without making a change, press F2 (>).

If the selection should be changed, press F3 (tgl).

5. Press F4 (entr).

4.5. Configure CPU Redundancy

If the Bus Interface Unit will be used on the same bus with two controllers (PLCs or host computers) and both of the controllers will send it outputs, the Bus Interface Unit must be set up for CPU Redundancy. The two types of CPU Redundancy, Hot Standby and Duplex, are defined below. If either type of redundancy is selected, the Bus Interface Unit will automatically provide inputs and diagnostics to both of the redundant CPUs.

If the station contains any analog modules, the only form of CPU redundancy permitted is Hot Standby. The Hand-Held Monitor will permit selection of either type of CPU redundancy. Do not select Duplex if there are any analog modules in the station.

```

CPU Redundancy
No Cntl Redund
< > tgl entr

```

If you want to go to the next screen without making a change, press F2 (>).

2. If the selection should be changed, press F3 (tgl).

Hot Standby CPU Redundancy

A device configured for Hot Standby redundancy receives outputs from both CPUs. It is normally controlled by Device Number 31. If no outputs are available from Device Number 31 for a period of three bus scans, the outputs are immediately controlled by Device Number 30. If outputs are not available from either Device Number 30 or 31, outputs go to their configured default or hold their last state. In Hot Standby redundancy, Device Number 31 always has priority, so that when Device Number 31 is on-line, it controls of the outputs.

Duplex CPU Redundancy

Only all-discrete stations can operate in Duplex redundancy mode. In Duplex mode, a device receives outputs simultaneously from both Device Number 30 and 31. The device compares the outputs. If corresponding outputs are the same, the device sets the output to that state. If corresponding outputs are not the same, the device will set the output to its configured ON or OFF Duplex Default State, which must be configured for all outputs in the station. If either Device Number 30 or 31 stops sending outputs to a device, its outputs are directly controlled by the remaining device. If both 30 and 31 stop sending outputs, the outputs in the station either default to their programmed default state (not the Duplex Default State) or hold their last state, as configured.

- 3. Press F4 (entr).

If you selected Duplex, the following screen appears:

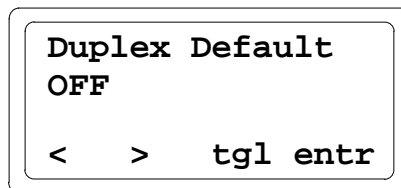

In Duplex Redundancy mode, if the Bus Interface Unit may receive *different* output states for given points from the two CPUs. If that happens, the Bus Interface Unit “breaks the tie” by outputting the Duplex Default State to those points.

If you want to go to the next screen without making a change, press F2 (>).

- 2. To change the Duplex Default state, press F2 (tgl).
- 3. Press F4 (entr) to save the new selection.

Note

If the Bus Interface Unit loses communications with BOTH CPUs, individual outputs go to their configured Hold Last State or Output Default State. (This selection is part of the individual modules’ configurations).

4.6. Select Configuration Protection

This feature can be used to protect the station configuration. To make subsequent changes, protection must be removed again. Before the station is used, its configuration should be protected.

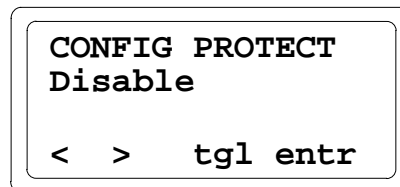

1. If the selection shown on line 3 should be changed, press F3 (tgl). Press F4 (entr).
2. This is the last N80 Bus Interface Unit configuration screen.

4.6.1. Tag Name Screen

Display only.

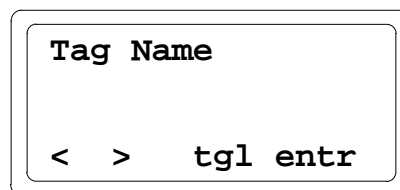

4.6.2. Review or continue configuration

- If you want to review or change any of the Bus Interface Unit configuration entries, use the F1 (<) key to return to the first Bus Interface Unit configuration screen.
- If you want to continue to the next configuration screen, press the F2 (>) key.

5. CONFIGURE ALSPA CE80–20 MODULES

Display the Bus Interface Unit configuration menu.

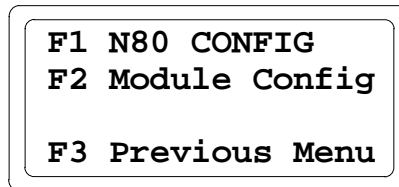

From the Configuration Menu, press F2 to configure the individual modules in the station.

5.1. Enable/Disable the I/O Scan

On the next screen, you can enable or disable the Bus Interface Unit's I/O scanning. (The Bus Interface Unit begins scanning I/O as soon as it is powered up). Disabling the I/O scan will leave inputs and outputs holding their last states.

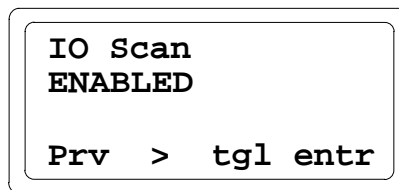

1. If you want to change the present selection, press F3 (tgl).
2. Press F4 (entr). If you want to go to the next screen without changing the selection, press F2 (>).

5.2. Disable Network I/O Updates

On this screen, you can enable or disable I/O updates between the BIU and the bus. The BIU continues scanning the I/O modules, but does not exchange the data on the bus. An Alspa C80–75 PLC will not report this condition as a Loss of Device. However, any alarm contacts in the Alspa C80–75 PLC that are assigned to the BIU will be set.

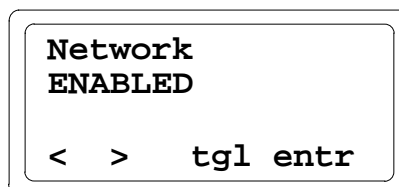

When the network scan is disabled, all inputs hold last state. For previously-configured modules, outputs mapped to the network will either default or hold their last state or value, as configured.

1. If you want to change the present selection, press F3 (tgl).
2. Press F4 (entr). If you want to go to the next screen without changing the selection, press F2 (>).

6. CONFIGURE THE NETWORK MAP FOR THE BUS INTERFACE UNIT

The next screens are used to assign the starting addresses and lengths for the Bus Interface Unit’s network map.

This is the data exchanged on the N80 bus.

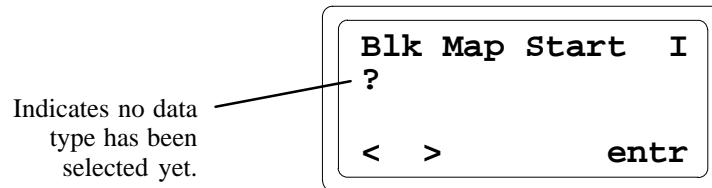

- I discrete inputs (bits)
- Q discrete outputs (bits)
- A analog inputs (16-bit words)
- AQ analog outputs (16-bit words)

If the system host is an Alspa 8000 PLC, the lengths must correspond to the memory assignments made for the Bus Interface Unit during PLC configuration. The starting data addresses configured for the BIU network map and the I/O modules in the station usually match the references configured for the PLC, but that is not required.

The following table shows the maximum amount of each data type that may be configured in the network map and the highest reference address available for each type.

BIU Memory Type	Used For	Maximum Length for Network Map	Highest Available Reference Address
I	discrete inputs and status data from intelligent modules	up to 1024 contiguous bits	65535
Q	discrete outputs and fault clearing for intelligent modules	up to 1024 contiguous bits	65535
AI	analog inputs	up to 64 contiguous words	9999
AQ	analog outputs	up to 64 contiguous words	9999

Data to be exchanged on the bus must use references configured here. Any I/O modules (or portions of modules) configured outside the network map will be scanned by the Bus Interface Unit, but the data will not be exchanged on the N80 network bus.

The I/O references of modules in the I/O station are configured separately. Individual I/O modules may be configured anywhere within available memory. It is possible to have inputs or outputs within the I/O station that are not exchanged on the N80 bus—that is, data that is completely local to the I/O station. For example, the I/O station might include a Micro Field Processor performing local data processing.

6.1. Configuring Extra References in the BIU I/O Map

Normally, there is no need to configure extra I/O references in the BIU's network I/O map. Although unused references do not contain meaningful data, they do add to the N80 bus scan time.

One circumstance under which it might be best to configure extra I/O references would be to allow for future addition of I/O modules to a station in a system where the host uses the same reference addresses for data as the BIU. In such a system, reserving extra references or leaving vacancies at configuration time can be a convenient way to prepare for future additions to a station. (In a system where the BIU's reference addresses are not used by the host, changing the BIU's I/O map does not affect the host so there is no need to configure unused references for future modules).

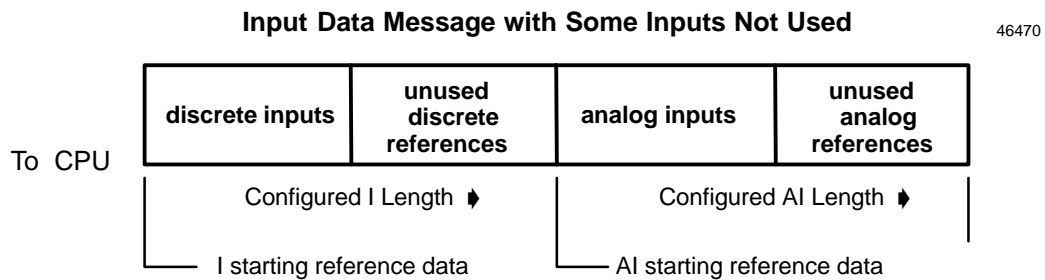

6.2. Example

An application has two stations in a system where the host uses the BIU reference addresses.

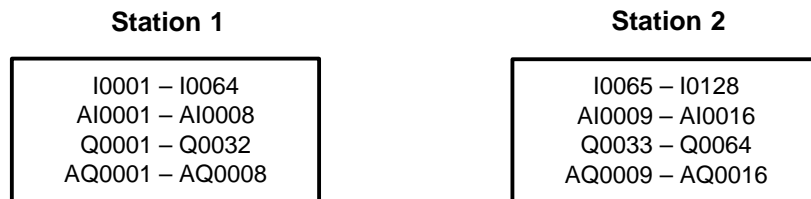

At a later time, it becomes necessary to add a discrete input module to station 1. However, in station 1, there are already enough input modules to use all of the assigned input references (I0001 – I0064). Ideally, the extra module would be added to station 1 at I00065, but that is already used as a reference in station 2. The alternatives at this stage are:

1. Change the map of station 2 to free up the needed contiguous I references.
2. Change the map of station 1 to start at higher references, such as I0097 – I0160.
3. Add a third I/O station to accommodate the additional modules.

It would have been easier to add the module to station 1 if extra references had been configured originally or if some vacancies had been allowed, as shown below.

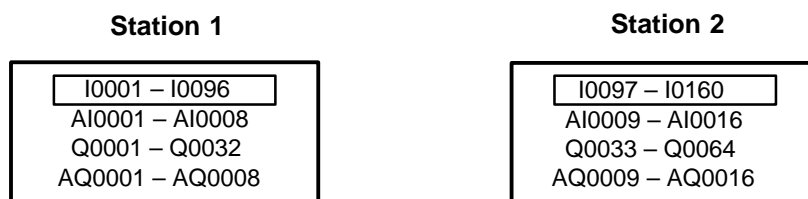

You might use a worksheet like the one shown below to record the I/O references and Reference Parameters configured for the Bus Interface Unit and for the modules in the I/O Station.

Slot 0 is the location of the BIU. The references you enter for the BIU are the ones that will be communicated on the N80 bus.

Slots 1 to 8 (maximum) contain conventional I/O modules or intelligent modules. You will find a worksheet below where you can record I/O assignments made for Group Data moves for intelligent modules such as the Micro Field Processor.

Conventional discrete and analog I/O modules use just one type of data. However, “intelligent” I/O modules can use multiple data types. See Subsection 20.4. for more information.

Module References and Reference Parameters Worksheet

Slot	Module Type	Module Type	Reference	Data Type	Set
0	Bus Interface Unit (These references are the ones transferred on the N80 bus).	I		bits	
		Q		bits	
		AI		2-byte words	
		AQ		2-byte words	
1		I		bits	
		Q		bits	
		AI		2-byte words	
2		AQ		2-byte words	
		I		bits	
		Q		bits	
3		AI		2-byte words	
		AQ		2-byte words	
		I		bits	
4		Q		bits	
		AI		2-byte words	
		AQ		2-byte words	
5		I		bits	
		Q		bits	
		AI		2-byte words	
6		AQ		2-byte words	
		I		bits	
		Q		bits	
7		AI		2-byte words	
		AQ		2-byte words	
		I		bits	
8		Q		bits	
		AI		2-byte words	
		AQ		2-byte words	

1. For each data type to be exchanged on the bus, enter a starting address and a length. This screen shows the data type (I) and a starting address (00001) for discrete input data:

```
Blk Map Start I
I00001
< >      entr
```

2. You can edit the address or press F4 to accept it. Then, enter a length in bits for the I data. For example:

```
Blk Map Lngth I
64
< >      entr
```

3. Press F4 (entr) to accept the value.

Continue as above, entering starting addresses and lengths for the other data types. Lengths for AI and AQ are 2-byte words.

Note

The lengths entered must not add up to more than 128 bytes of inputs (discrete + analog) and 128 bytes of outputs (discrete + analog).

The lengths selected should include all the I/O data that will be exchanged on the bus. If a data length is too short, modules that overflow the configured limit will not be serviced by the main CPU system.

5. After entering the length for AQ data (the fourth data type), press F1 (>).

If you changed any starting address or length entries, the HHM displays this screen:

```
Map has changed
Accept ?
no yes
```

6. To accept the changes and continue to the next menu, press F4 (yes).

7. ADD MODULES AND ASSIGN REFERENCES

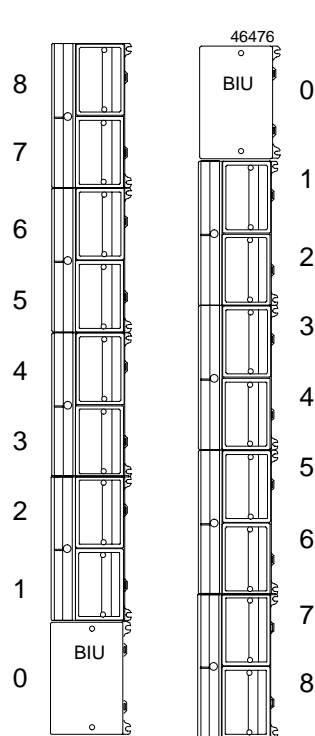

The steps for configuring an I/O module depend on whether or not the module is present at the time of configuration. “Intelligent” modules (see the list below) must be present to be configured, conventional I/O modules do not have to be present.

Slot Number refers to the location of the module in the station, relative to the Bus Interface Unit. See the illustration at left.

If the slot has not already been configured, after configuring the I/O map, the HHM displays:

```
S:1      Empty
< > tgl read
```

If the slot has previously been configured, the HHM shows the existing configuration. For example:

```
S:1      Q:16
Q01785-Q01800
< > del zoom
```

Figure 5.2 – Module slot numbers

See the instructions on the next two pages to configure the slot.

Module Present, Read/Zoom to configure:	Module Present, Read/Enter to configure or No Module Present, Select Special I/O to configure:	No Module Present, Select Generic I/O to configure:
Analog 16-Point Grouped Input Module: IC670ALG240	Analog 8 volt In	Discrete Input 4/8
Analog 8-Point Voltage Input Module:IC670ALG281	Analog 8 cur In	Discrete Input 16
Analog 16-Point Voltage Input Module: IC670ALG282	Analog 4 cur Out	Discrete Output 4/8
Analog Voltage Output Module: IC670ALG310	ESCP 8 Disc Out	Discrete Output 16
Analog Current-source Output Module: IC670ALG330	Combo Disc 10/06	
Analog RTD Input Module: IC670ALG620		
Analog Thermocouple Input Module: IC670ALG630		
Micro Field Processor: IC670MFP100		

7.1. Configuration with No Module Present

If the module is not present in the selected slot, press the F3 (tgl) key to specify a module type. The following screen will appear:

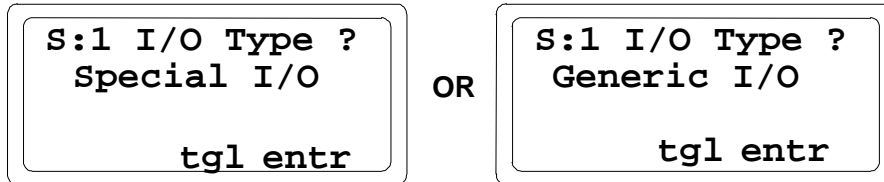

1. Press F3 (tgl) to select Generic I/O or Special I/O. Then press F4 (entr).
2. Use the F3 (tgl) key again to go through the module names listed below. When the correct module name appears, press F4 (entr).
3. Complete the module configuration as described in this chapter.

7.2. Read a Module Identification with the Module Present

If there is a module in the currently-selected slot, pressing F4 (read) from the “empty slot” screen brings up the module’s identification screen. For example:

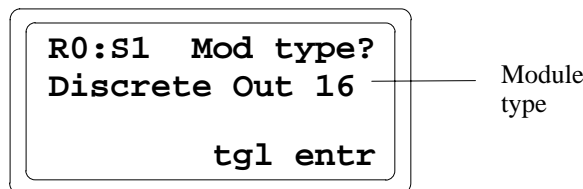

If you want to change the module type displayed, press F3 (tgl) to see the names of other module types.

Example screen for an intelligent module (press F4 (zoom) to configure the I/O references as described in this chapter). You cannot change the module type of an intelligent module.

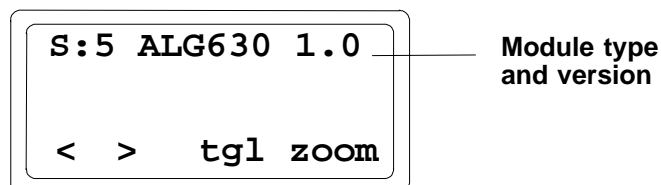

7.3. Delete an Existing Module Configuration

To delete the configuration of the module in the present slot, press F3 (delete) then F4 (enter). Note that this removes the entire module configuration.

8. CONFIGURE A DISCRETE INPUT MODULE

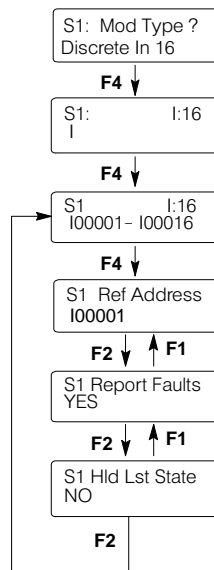

After you “accept” the module into the slot, a screen like this appears:

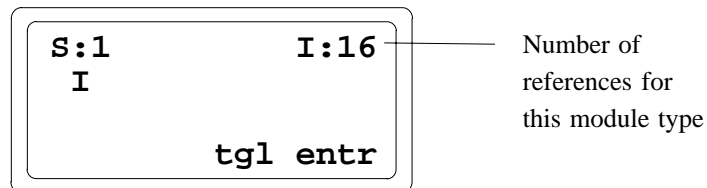

8.1. Assign I/O References for the Module

Specify the I/O references to be used by the module. For most applications, you can simply have the Bus Interface Unit assign the next available references in that memory type. Alternatively, you can enter specific references for the module.

- A. To assign the next available references, just press F4 (entr).
- B. If you want to change to another type of I/O table, press F3 (toggle).
- C. If you want to assign specific references, enter the starting address. Press F4 (entr).

For most applications, all module references should fall within the network map configured for the Bus Interface Unit (see Section 6. for more information). For local control, a module can be configured outside the BIU network map.

In addition, each data type (I, Q, AI, AQ) has a total of 256 bytes allocated within the BIU. So for each data type, all references must be located within a 256-byte range. For example, if the starting address for input data configured for the Bus Interface Unit was I01024, all module inputs would need to be located between I01024 and I03072. (Discrete references are assigned on byte boundaries).

Module references are automatically assigned by the Bus Interface Unit based on its configured data addresses and the number of points appropriate for the module type. For example:

```
S:1          I:16
I00001- I00016

< > del zoom
```

In the example illustrated above, the Bus Interface Unit assigns 16 references beginning at I00001 to a 16-point input module. In the same system, the next discrete input module in the station would automatically be assigned references beginning at I00017.

To edit the module's configuration, press F4 (zoom).

8.2. Module Fault Reporting

After zooming in from the reference address configuration screen, configure whether or not the Bus Interface Unit will report faults from the module to the network controller.

```
S1 Report Faults
YES

prv > tgl entr
```

1. Use the F1 (previous) key if you want to return to the previous screen.
2. If you want to change the current selection, press F3 (tgl).
3. Use the F4 (entr) key to save the selection.
4. Press F2 to go to the next screen.

8.3. Default Inputs or Hold Last State

Next, configure what type of data the Bus Interface Unit should provide to the BIU internal table if it stops receiving actual input data from the module.

```
S1 Hld Lst State
NO
< > tgl entr
```

1. Select YES if the Bus Interface Unit should hold inputs in their last states and supply that data to the BIU internal table.
Select NO if the Bus Interface Unit should default all the module's inputs to 0 and supply that data to the BIU internal table instead.
2. Use the F4 (entr) key to save the selection.
3. Press F2 (>) to return to the original slot configuration screen.

9. CONFIGURE A DISCRETE OUTPUT MODULE

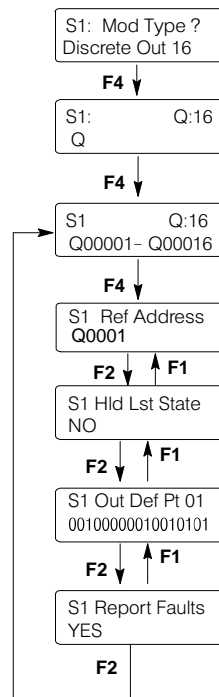

After you “accept” a module into the slot, a screen like this appears:

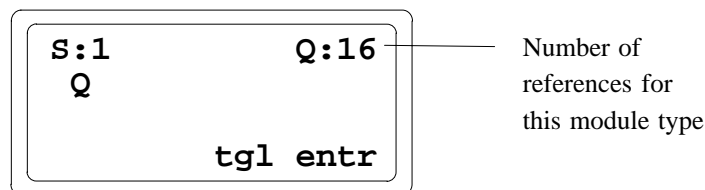

9.1. Assign I/O References for the Module

Specify the I/O references to be used by the module. For most applications, you can simply have the Bus Interface Unit assign the next available references in that memory type. Alternatively, you can enter specific references for the module.

- A. To assign the next available references, just press F4 (entr).
- B. If you want to change to another type of I/O table, press F3 (toggle).
- C. If you want to assign specific references, enter the starting address. Press F4 (entr).

For most applications, all module references should fall within the network map configured for the Bus Interface Unit (see Section 6. for more information). For local control, a module can be configured outside the BIU network map.

In addition, each data type (I, Q, AI, AQ) has a total of 256 bytes allocated within the BIU. So for each data type, all references must be located within a 256-byte range. For example, if the starting address for output data configured for the Bus Interface Unit was Q01024, all module outputs would need to be located between Q01024 and Q03072. (Discrete references are assigned on byte boundaries).

Module references are automatically assigned by the Bus Interface Unit based on its configured data addresses and the number of points appropriate for the module type.

To edit the module's configuration, press F4 (zoom).

9.2. Default Outputs or Hold Last State

After selecting the module's reference address, configure what type of data the Bus Interface Unit should provide to the module if it stops receiving outputs from the network.

```
S1 Hld Lst State
NO
< > tgl entr
```

1. Select YES if the Bus Interface Unit should hold outputs in their last states and supply that data to the module. Select NO if the Bus Interface Unit should default all the module's outputs and supply that data to the module instead. **Note:** This selection has no effect if the BIU itself fails.
2. Use the F4 (entr) key to save the selection.

If Hold Last State is set to NO, the following screen appears:

```
S1 Out Def Pt 01
_0010000010010101
< > tgl entr
```

Number of the point
at the cursor location

3. On this screen, select a default state (1 or 0) for each output.
4. Use the cursor keys to select outputs. Use the F3 (toggle) key to change the state of the output at the present cursor location.
5. Use the F4 (entr) key to save the selections.

9.3. Module Fault Reporting

On the next screen, configure whether or not the Bus Interface Unit will report faults from this module to the network controller.

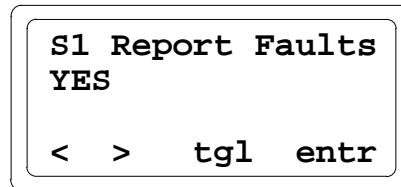

1. If you want to change the current selection, press F3 (tgl).
2. Use the F4 (entr) key to save the entry. Press F2 (>) to return to the original slot configuration screen.

10. CONFIGURE A DISCRETE INPUT/OUTPUT MODULE

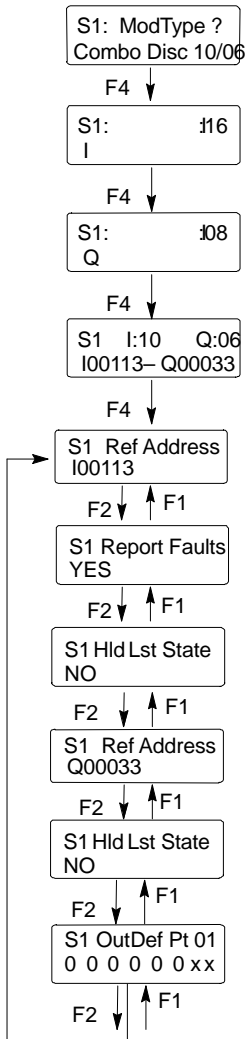

After you "accept" a module into the slot, a screen like this appears:

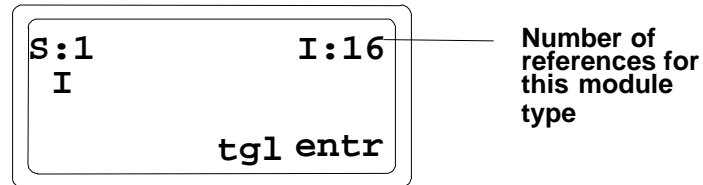

10.1. Assign I/O References

Specify the references to be used by the module. For most applications, you can simply have the Bus Interface Unit assign the next available references in that memory type. Alternatively, you can enter specific references for the module.

- To assign the next available references, just press F4 (entr).
- If you want to change to another type of I/O table, press F3 (toggle).
- If you want to assign specific references, enter the starting address. Press F4 (entr).

For most applications, all module references should fall within the network map configured for the Bus Interface Unit. For local control, a module can be configured outside the BIU network map.

In addition, each data type (I, Q, AI, AQ) has a total of 256 bytes allocated within the BIU. So for each data type, all references must be located within a 256-byte range. For example, if the starting address for output data configured for the Bus Interface Unit was Q01024, all module outputs would need to be located between Q01024 and Q03072. (Discrete references are assigned on byte boundaries).

Module references are automatically assigned by the Bus Interface Unit based on its configured data addresses and the number of points appropriate for the module type.

To edit the module's configuration, press F4 (zoom).

10.2. Module Fault Reporting

On the next screen, configure whether or not the Bus Interface Unit will report faults from this module to the network controller.

```
S1 Report Faults
YES
< > tgl entr
```

1. If you want to change the current selection, press F3 (tgl).
2. Use the F4 (entr) key to save the entry. Press F2 (>) to return to the original slot configuration screen.

10.3. Default Inputs or Hold Last State

Next, configure what type of data the Bus Interface Unit should provide to the network if it stops receiving inputs from the module.

```
S1 Hld Lst State
NO
< > tgl entr
```

1. Select YES if the Bus Interface Unit should hold inputs in their last states and supply that data to the network. Select NO if the Bus Interface Unit should default all the module's inputs and supply that data to the network instead.

Note

This selection has no effect if the BIU itself fails.

2. Use the F4 (entr) key to save the selection.

10.4. Default Outputs or Hold Last State

You should also configure what type of data the Bus Interface Unit should provide to the module if it stops receiving outputs from the network.

```

S1 Hld Lst State
NO
< > tgl entr

```

1. Select YES if the Bus Interface Unit should hold outputs in their last states and supply that data to the module. Select NO if the Bus Interface Unit should default all the module's outputs and supply that data to the module instead.

Note

This selection has no effect if the BIU itself fails.

2. Use the F4 (entr) key to save the selection.
If Hold Last State is set to NO, the following screen appears:

```

S1 Out Def Pt 01
_0 0 0 0 0 0 x x
< > tgl entr

```

Number of the point
at the cursor location

3. On this screen, select a default state (1 or 0) for each output.
4. Use the cursor keys to select outputs. Use the F3 (toggle) key to change the state of the output at the present cursor location.
5. Use the F4 (entr) key to save the selections.

11. CONFIGURE A CONVENTIONAL ANALOG INPUT MODULE

After you “accept” a module into the slot, a screen like this appears:

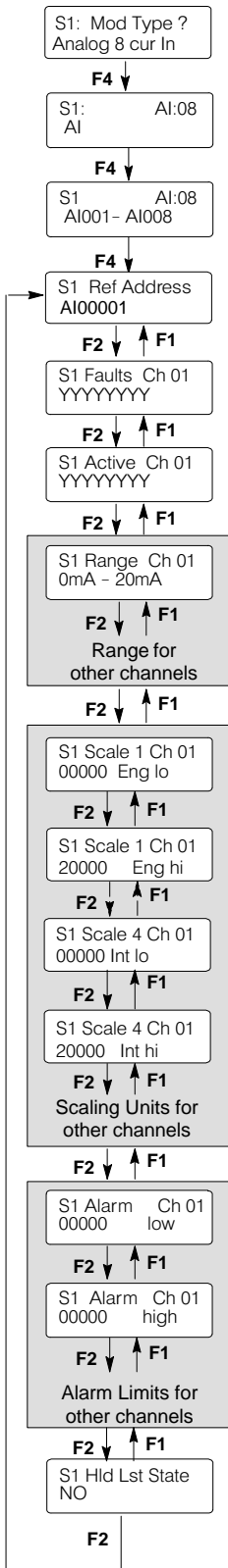
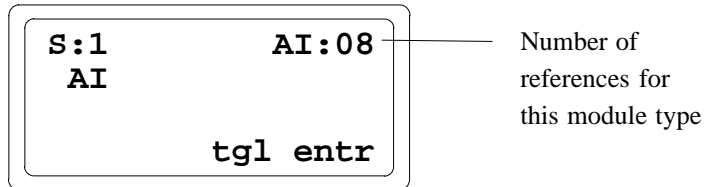

11.1. Assign I/O References for the Module

Specify the I/O references to be used by the module. For most applications, you can simply have the Bus Interface Unit assign the next available references in that memory type. Alternately, you can enter specific references for the module.

- A. To assign the next available references, press F4 (entr).
- B. If you want to change to another type of I/O table, press F3 (toggle).
- C. If you want to assign specific references, enter the starting address. Press F4 (entr).

For most applications, all module references should fall within the network map configured for the Bus Interface Unit (see Section 6. for more information). For local control, a module can be configured outside the BIU network map.

In addition, each data type (I, Q, AI, AQ) has a total of 256 bytes allocated within the BIU. So for each data type, all references must be located within a 256-byte range. For example, if the starting address for analog input data configured for the Bus Interface Unit was AI0101, all analog inputs would need to be located between AI0101 and AI0228.

Module references are automatically assigned by the Bus Interface Unit based on its configured data addresses and the number of points appropriate for the module type.

To edit the module’s configuration, press F4 (zoom).

11.2. Channel Fault Reporting

The Bus Interface Unit can report faults for each channel to the network controller. If fault reporting is enabled for a channel, the Bus Interface Unit sends a message to the network controller (such as an Alspa 8000 PLC Bus Controller) if any fault occurs on that channel. If fault reporting is disabled, the Bus Interface Unit does not send fault reports for the channel to the network controller.

Regardless of whether fault *reporting* is enabled, the Bus Interface Unit detects faults on the circuit and takes appropriate action. If a fault occurs, the fault condition must be corrected for proper operation of the I/O module.

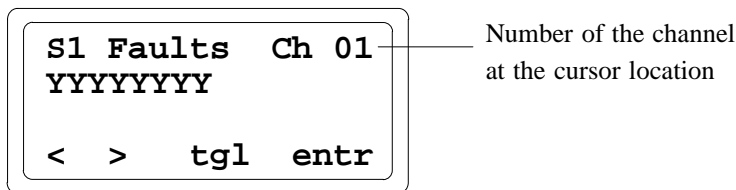

1. For each channel, select Y if the Bus Interface Unit should report module faults to the network controller for that channel. Select N if it should not.
2. Use the F1 (<) and F2 (>) keys to select channels.
3. Use the F3 (toggle) to change the selection at the present cursor location.
4. Use the F4 (entr) key to save the selections on this screen.
5. Press F2 to go to the next screen.

11.3. Channel Active

When a channel is configured as Active, it is scanned for data and checked for errors. If a channel should not be scanned, that channel can be configured as inactive. An inactive input channel returns no faults and no data.

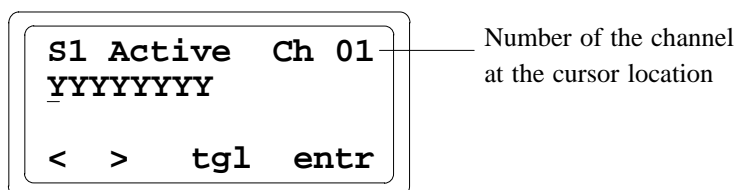

1. For each channel, select Y if the channel should be active. Select N if it should not.
2. Use the F1 (<) and F2 (>) keys to select channels.
3. Use the F4 (entr) key to save the selections on this screen.
4. Press F2 to go to the next screen.

11.5. Input Scaling

Based on the actual analog input signal level for a channel, the analog input module reports a value from decimal 0 to 4095 to the Bus Interface Unit. The Bus Interface Unit can convert this digital input to a value that is more meaningful to the application by using the “scaling values” configured on this screen.

For each channel, two sets of values are configured: high and low “scaled” values and the actual high and low digital values they represent. Based on these two pairs of values, the Bus Interface Unit will be able to scale values for all other input levels.

See Appendix A for information on finding appropriate scaling values for your application. If you do not have scaling values ready, you can continue to the next screen now and configure scaling at another time. The Bus Interface Unit will use default scaling values of 1:1 if no scaling values are entered.

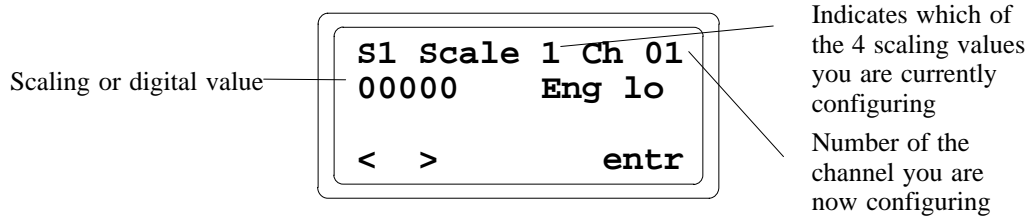

1. For EACH channel in turn, enter scaling values in this order:

Low scaling value (“eng lo”)
High scaling value (“eng hi”)
Low digital value (“int lo”)
High digital value (“int hi”)

2. If you press F2 (>), the display goes from value to value in sequence. If you press F1 (<), the display goes to the first value for the previous channel.
3. Use the HHM keypad to enter values. To enter a negative value, first enter the numbers, then press the - key.
4. Use the F4 (entr) key to save the selections on this screen 5. Press F2 to the next screen.
5. Press F2 to go to the next screen.

11.6. Alarm limits

Each input channel can have two Alarm Thresholds, one for a low engineering units (scaled) value and one for a high value.

Maximum values are ± 32767 . The high threshold should be greater than the low threshold. Threshold limits are based on circuit scaling. If scaling is changed, review and readjust the Alarm Thresholds if necessary.

Alarm Thresholds can be set anywhere over the dynamic range of the signal. Typically, they are set at levels beyond which the input should not operate or levels beyond which alternate processing is required. They can also be set beyond the dynamic range of the signal, ensuring that they will never be activated. See the examples below.

1. For EACH channel in turn, first, enter a low alarm value:

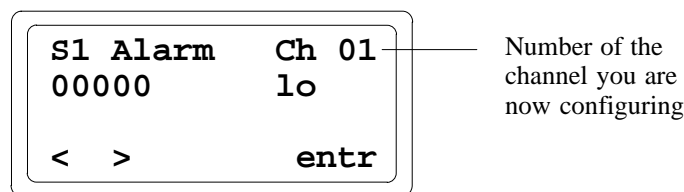

2. Press F4 (entr) key.
3. Then enter a high alarm value:

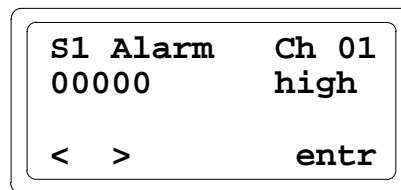

4. Use the F1 (<) and F2 (>) keys to select channels.
5. Press F4 (entr) key to save the selection 6. Press F2 (>) to return to the original slot configuration screen.
6. Press F2 (>) to go to the next screen.

Example 1: A circuit is expected to report engineering unit values of -6 m/sec (-20 ft/sec) to +55 m/sec (+180 ft/sec). The high alarm is set at +45 m/sec (+150 ft/sec) and the low alarm at -7.5 m/sec (-25 ft/sec).

If an input reached its high alarm, a new threshold could be set. This could generate a high-high alarm or an alarm-cleared threshold.

Example 2: A circuit is expected to report engineering unit values of -6 m/sec (-20 ft/sec) to +55 m/sec (+180 ft/sec). The high alarm is set at +45 m/sec (+150 ft/sec) and the low alarm at -7.5 m/sec (-25 ft/sec).

An Alarm Threshold is set at +45 s/sec (+150 ft/sec). Upon receiving an alarm message, the CPU changes the Alarm Threshold to +50 m/sec (+165 ft/sec) by using a Write Configuration command and sends the appropriate Clear Circuit Fault command. No alarm message is sent upon changing the threshold unless the speed is greater than +50 m/sec (+165 ft/sec). If the speed is only +48 m/sec (+157 ft/sec) but increasing, a second message would be sent at +50 m/sec (+165 ft/sec). Since these two diagnostic messages are the same, it would be necessary for the program to keep track of the level of the Alarm Thresholds and recognize this as a higher alarm than that received initially. At the same time, it could move the low alarm to +42 m/sec (140 ft/sec) and use this level to detect the end of the high alarm conditions.

11.7. Default Inputs or Hold Last State

Next, configure what type of data the Bus Interface Unit should provide to the network controller if it stops receiving actual input data from the module.

```
S1 Hld Lst State
NO
< > tgl entr
```

1. Select YES if the Bus Interface Unit should hold inputs in their last states and supply that data to the network controller.

Select NO if the Bus Interface Unit should default all the module's inputs to 0 and supply that data to the network controller instead.

2. Use the F4 (entr) key to save the entry and go on to the next configuration step.
3. Press F2 (>) to return to the original slot configuration screen.

12. CONFIGURE A CONVENTIONAL ANALOG OUTPUT MODULE

After you “accept” a module into the slot, a screen like this appears:

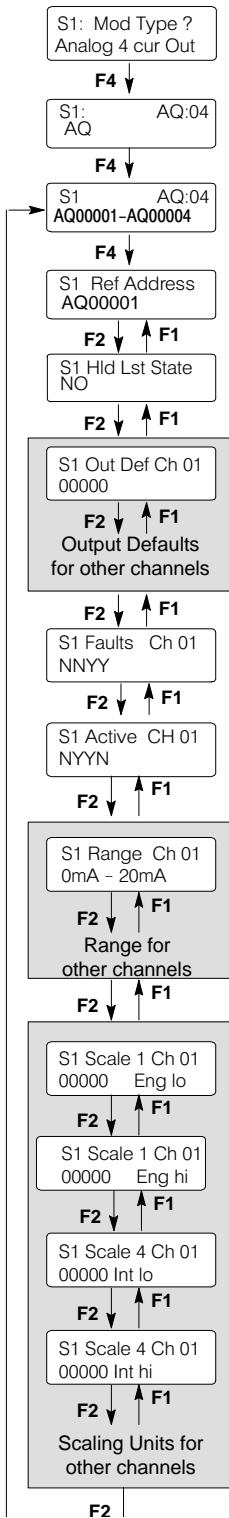
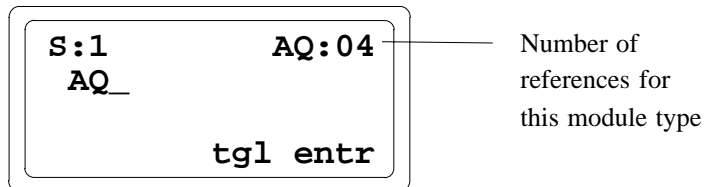

12.1. Assign I/O References for the Module

Specify the I/O references to be used by the module. For most applications, you can simply have the Bus Interface Unit assign the next available references in that memory type. Alternately, you can enter specific references for the module.

- A. To assign the next available references, just press F4 (entr).
- B. If you want to change to another type of I/O table, press F3 (toggle).
- C. If you want to assign specific references, enter the starting address. Press F4 (entr).

For most applications, all module references should fall within the network map configured for the Bus Interface Unit (see Section 6. for more information). For local control, a module can be configured outside the BIU network map.

In addition, each data type (I, Q, AI, AQ) has a total of 256 bytes allocated within the BIU. So for each data type, all references must be located within a 256-byte range. For example, if the starting address for analog output data configured for the Bus Interface Unit was AQ0101, all analog outputs would need to be located between AQ0101 and AQ0357.

Module references are automatically assigned by the Bus Interface Unit based on its configured data addresses and the number of points appropriate for the module type.

To edit the module’s configuration, press F4 (zoom).

12.2. Default Outputs or Hold Last State

After zooming in from the reference address screen, configure what type of data the Bus Interface Unit should provide to the module if it stops receiving actual output data from the network controller.

```

S1 Hld Lst State
NO
< > tgl entr

```

1. Select YES if the Bus Interface Unit should hold outputs in their last states and supply that data to the module. Select NO if the Bus Interface Unit should default all the module's outputs and supply that data to the module instead.

Note

This selection has no effect if the BIU itself fails.

2. Press F4 to save the selection.
3. Press F2 (>) to go to the next screen.

12.3. Output Default Values

If Hold Last State is set to NO, the following screen appears:

```

S1 Out Def Ch 01
00000
< > entr

```

1. Enter output default values from the HHM keypad. To enter a negative value, press the minus key after entering the value.
2. Use the F1 (<) and F2 (>) keys to select channels.
3. Press F4 (entr) key to save the selection and go on to the next item.
4. Press F2 (>) to go to the next screen.

12.4. Channel Fault Reporting

The Bus Interface Unit can report faults for each channel to the network controller. If fault reporting is enabled for a channel, the Bus Interface Unit sends a message to the network controller if any fault occurs on that channel. If fault reporting is disabled, the Bus Interface Unit does not send fault reports for the channel to the network controller.

Regardless of whether fault *reporting* is enabled, the Bus Interface Unit detects faults on the circuit and takes appropriate action. If a fault occurs, the fault condition must be corrected for proper operation of the I/O module.

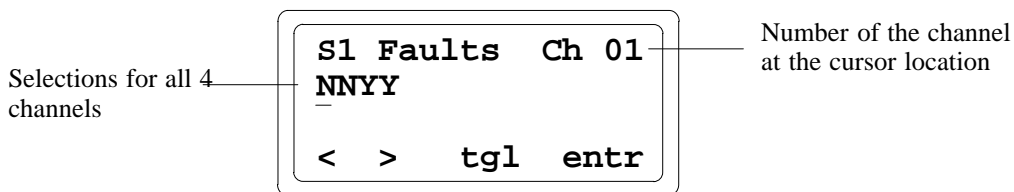

1. Use the F3 (tgl) key to select Y or N for each channel. Select Y if the Bus Interface Unit should report module faults to the network controller for that channel. Select N if it should not.
2. Use the F1 (<) and F2 (>) keys to select move the cursor (selects channels). If Hold Last State is set to NO, pressing F1 (<) from the first channel displays the Output Default screen.
3. Use the F4 (entr) key to save the selections on this screen.
4. Press F2 (>) to go to the next screen.

12.5. Channel Active

When a channel is configured as Active, it is scanned for data and checked for errors. If a channel should not be scanned, that channel can be configured as inactive. An inactive input channel provides no faults and uses no data.

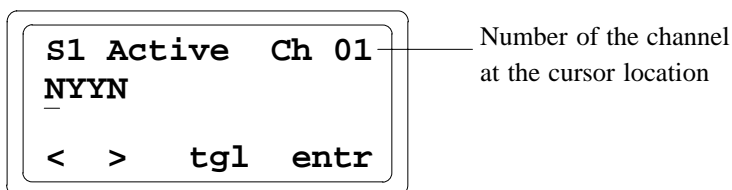

1. For each channel, select Y if the channel should be active. Select N if it should not.
2. Use the F1 (<) and F2 (>) keys to select channels.
3. Use the F4 (entr) key to save the selections on this screen.
4. Press F2 (>) to go to the next screen.

12.7. Output Scaling

While the actual values received from the application program may represent various types of engineering units, the Bus Interface Unit reports values from decimal 0 to 4095 to an analog output module. The BIU converts the application data using “scaling values” configured for each output channel.

For each channel, two sets of values are configured: high and low “scaled” values and the actual high and low digital values they represent. Based on these two pairs of values, the Bus Interface Unit will be able to scale values for all other output levels.

See Appendix A for information on finding appropriate scaling values for your application. If you don’t have scaling values ready, you can continue to the next screen now and configure scaling at another time. The Bus Interface Unit will use default scaling values of 1:1 if no scaling values are entered.

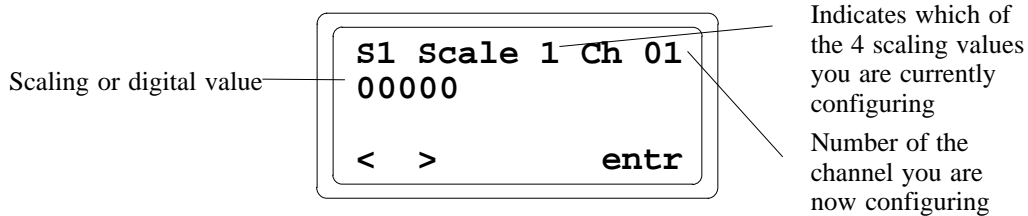

1. For EACH channel in turn, enter scaling values in this order:

- Low scaling value (“eng lo”)
- High scaling value (“eng hi”)
- Low digital value (“int lo”)
- High digital value (“int hi”)

2. If you press F2 (>), the display goes from value to value in sequence. If you press F1 (<), the display goes to the first value for the previous channel
3. Use the HHM keypad to enter values. To enter a negative value, first enter the numbers, then press the - key.
4. Use the F4 (entr) key to save the selections on this screen. Press F2 (>) to return to the original slot configuration screen.

13. CONFIGURE A 16-POINT GROUPED ANALOG INPUT MODULE

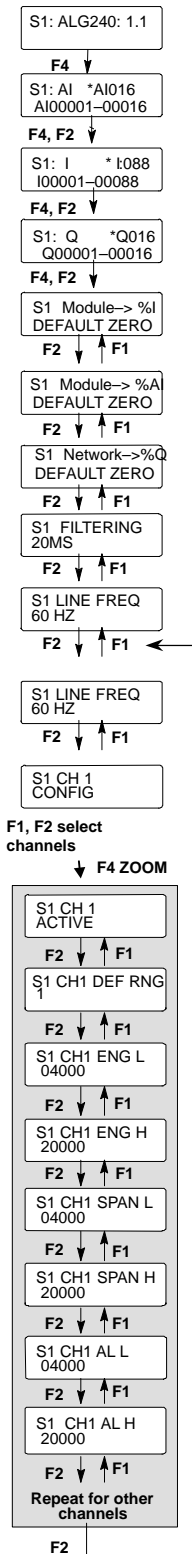

When you select “Read” from the empty slot HHM screen, this module screen appears:

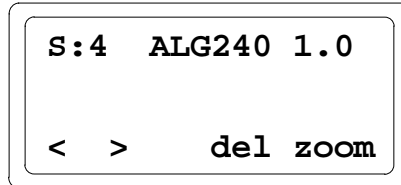

13.1. Assign I/O References for the Module

When you “zoom” into the module’s slot, a screen like this appears:

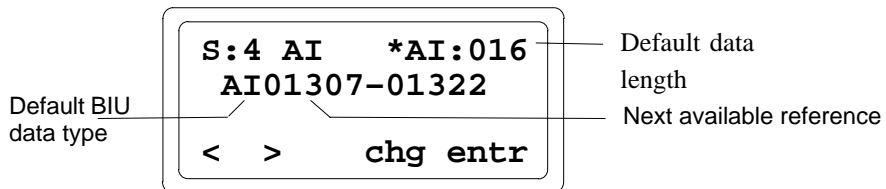

This screen shows the default table and length and the next available reference address in that table for that reference parameter. The length is displayed in units that are appropriate for that data type (AI and AQ are in words, Q and I are in bits). The asterisk indicates that this reference has not yet been defined.

If the present selection is acceptable, press F4 (enter) to accept it. The asterisk will disappear.

If you prefer to change the BIU table mapping, length or reference value, press F3 (change).

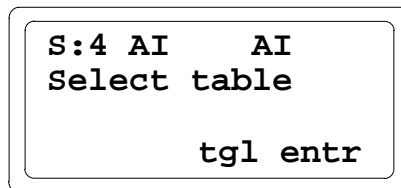

From this screen, you can display the other BIU data types by pressing F3 (toggle). Press F4 (enter) when the desired data type is displayed.

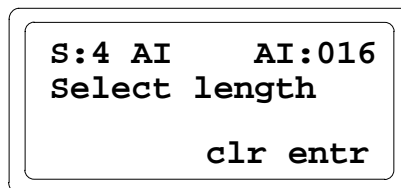

If you want to enter a different length for the displayed data type, press F3 (clear) to clear the length field. Enter the new length from the keypad. If you enter an invalid length, the HHM prompts: **BAD LENGTH ERR.**

After “entering” the correct length, the offset (starting reference) screen appears. The BIU automatically supplies the next available address in the selected table. You can press F4 (enter) to accept this value or F3 (clear) then enter a new value from the keypad. Press the F4 (enter) key after entering a new offset.

```
S:4 AI    AI:016
Ref Addr 01896
< >    clr entr
```

The 16-Point Grouped Analog Input Module is an intelligent module, which uses more than one type of data. See Subsection 20.4. for more information. Use the F2 (>) key to display the screen for the module’s discrete input diagnostic data.

```
S:4 I    * I:088
I01817-01904
< >    chg entr
```

You can edit this screen or accept it using the F4 (enter) key. The asterisk beside the data type disappears, to show that the current values have been saved.

```
S:4 I    I:088
I01817-01904
< >    chg entr
```

Next, go to the screen that shows the module’s discrete output references, which are used for fault clearing.

```
S:4 Q    * Q:016
Q01817-01832
< >    chg entr
```

You can also edit this screen. Use the F4 (enter key) to save the selections and continue to the next item. Note that all required references for the module must be entered. You can give a reference parameter a length of zero if you do not want to map the data to the BIU. If you attempt to back out before the references are all configured, the HHM displays the following screen:

```

Cfg Incomplete
Clear Slot?

      yes   no

```

If you exit, the references you have configured are not saved.

13.2. Configure Data Defaults

For data types AI and I, you can determine what the BIU should do with the module's data if the BIU loses communications with the module. Data can either be held at its present values or defaulted to zero.

You can accept DEFAULT: ZERO with the F4 (enter) key or press F3 (toggle) then F4 (enter) to change to DEFAULT: HOLD and save it.

```

S:4 Module-> %I
DEFAULT:ZERO

< >   tgl entr

```

```

S:4 Module-> %I
DEFAULT:HOLD

< >   tgl entr

```

```

S:4 Module-> %AI
DEFAULT:ZERO

< >   tgl entr

```

For data going to the module (type Q) which is included within the BIU's I/O map, you can determine what data the BIU will send to the module if the BIU loses communications with the network.

```

S:4 Network-> %Q
DEFAULT:ZERO

< >   tgl entr

```

13.3. Configure Filtering

Next, select the filtering delay to eliminate noise due to the AC power lines. Filtering increases the response time to changes in a channel.

The choices for filtering are:

- A. 10 ms: The module averages the most recent 8 samples of the input.
- B. 20 ms: The module averages the most recent 16 samples of the input.

The module will perform filtering on all inputs on the module that are configured as “active”.

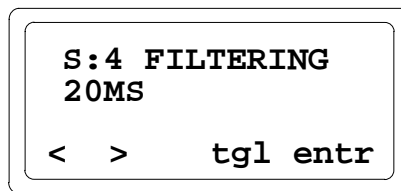

1. If you want to change the displayed selection, press F3 (Tgl).
2. Use the F4 (entr) key to save the selection.
3. Press F2 (>) to go to the next screen.

13.4. Configure the Line Frequency

Next, set the line frequency for the module. Select 50 or 60 Hz.

Disturbances due to AC noise cause variations around the desired DC level. The amplitude of these variations can be reduced by configuring the rate at which the module scans inputs for the operating frequency. If the line frequency is configured at 60 Hz, the module scans each input channel every 1.04 milliseconds. If the line frequency is configured at 50 Hz, the module scans each input channel every 1.25 ms.

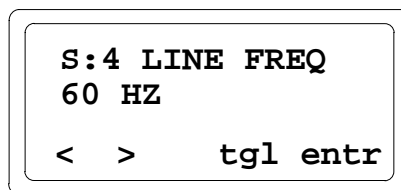

1. If you want to change the displayed selection, press F3 (Tgl).
2. Use the F4 (entr) key to save the selection.
3. Press F2 (>) to go to the next screen.

13.5. Circuit Configuration

The sequence in which circuit configuration screens appear depends on the revision level of the module, the Hand-Held Monitor and the BIU.

13.5.1. Channel Header

For module IC670ALG240, version 1.3 or later, if the BIU and Hand-Held Monitor support display of channel headers, a header screen appears for each channel as shown below:

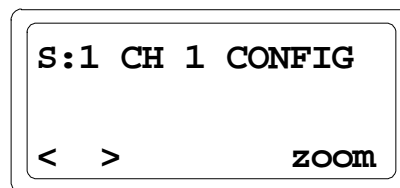

- A. Press F2 (>) from this screen to go to the header screen for the next channel. Pressing F2 (>) from channel 8 displays the module's first reference parameter screen.
- B. Press F1 (<) from this screen to go to the header screen for the previous channel. Pressing F1 (<) from channel 1 displays the module's last reference parameter screen.
- C. Press F4 (zoom) to go to the first configuration screen for the channel.
- D. When in a channel-specific configuration screen, press the up arrow/MENU key to go to that channel's header screen.

If the BIU and Hand-Held Monitor do not support display of channel headers, the header screens do not appear and keys F1 (<) and F2 (>) are used to scroll through channel-specific configuration screens.

The following features are configured for each channel.

13.5.2. Channel Active

When a channel is configured as Active, it is scanned for data and checked for errors. If a channel should not be scanned, that channel can be configured as inactive. An inactive input channel returns the value 0.

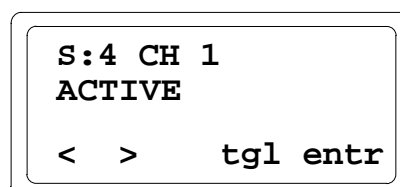

1. If you want to change the displayed selection, press F3 (Tgl).
2. Use the F4 (entr) key to save the selection.
3. Press F2 (>) to go to the next screen.

13.5.3. Input Range

On this screen, specify the range for the input. There are four predetermined range and data scaling combinations (selections 1, 2, 3 and 4), plus custom scaling (select “none”).

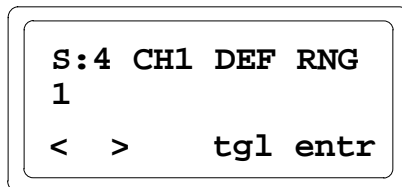

The default is 1. Selections 1 or 2 will convert the full input current span down to 0 milliamps and produce negative values below 4 mA. Selection 1 produces engineering unit data in microAmps. These also enable an “Open Wire” diagnostic bit which is true whenever the input falls below the normal range.

Selection	Input current (µA) = Data range
1	4000 to 20000 = 4000 to 20000
2	4000 to 20000 = 0 to 32000
3	0 to 20000 = 0 to 32000
4	0 to 24000 = 0 to 32000
none	Configurable scaling (see below)

13.5.4. Input Scaling

The following screens can be used to set up custom scaling values. The 16-Point Grouped Analog Input Module performs its own scaling (unlike conventional Alspa CE80–20 analog modules, whose scaling is performed by the BIU).

Scaling can be used to define a linear relationship between a channel’s input current in microAmps (μA) and the value in engineering units returned to the BIU. The default scaling configuration provides values from 4000 to 20000 for an input current range of 4 mA (low span value) to 20 mA (high span value).

To scale a channel, choose a high and low point and enter the actual input value (span) and a corresponding engineering units value for each. During operation, the module will use these values to convert input currents into digital values that represent engineering units. Scaling does not increase the resolution of the data, but it does transform the values returned to the BIU into more convenient units. The “Open Wire” diagnostic bit is enabled if actual input current value used for the “Low Point” is greater than 2 milliamps.

If the scaled data falls below the minimum for engineering units, the module returns the minimum engineering units value (–32768). If the scaled data rises above the maximum for engineering units, the module returns the maximum engineering units value (32767).

The illustration below shows the module’s default scaling.

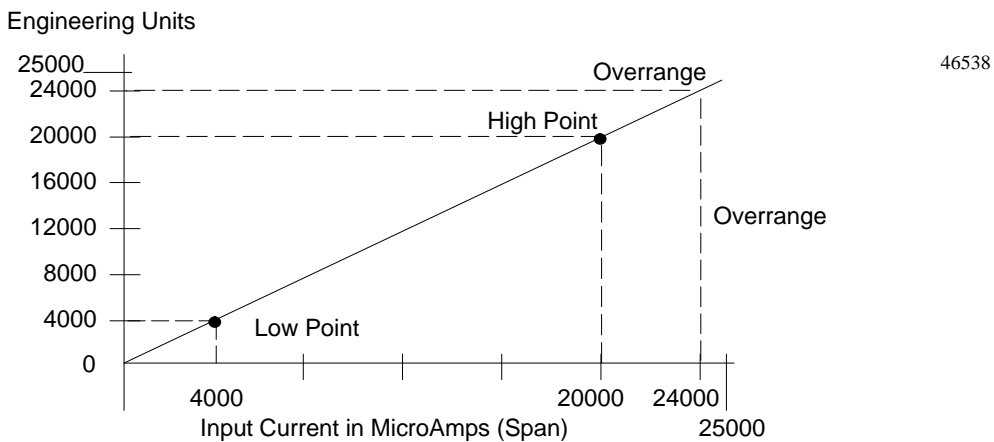

The first scaling screen shows the engineering units value that is considered equivalent to the low span (actual) value. Engineering units may be from –32768 to 32767.

```

S:4 CH1 EU L
  00000
< >   chg entr
    
```

Enter the high span value for the channel. This is the actual current in microAmps to be scaled to the high engineering units value.

```

S:4 CH1 EU H
  32000
< >   chg entr
    
```

Next, enter the actual current in microAmps to be scaled to the low engineering units value.

```
S:4 CH1 SPAN L
04000
< > chg entr
```

Span values are 16 unsigned integers ranging from 0 to 25000. After entering the low span value for the input, press the F4 (enter) key. Enter a high span value for the same input.

```
S:4 CH1 SPAN H
20000
< > chg entr
```

13.5.5. Alarm Limits

The next screen is used to set the low alarm limit for the channel in engineering units.

```
S:4 CH1 AL L
00000
< > chg entr
```

Each input channel can have a low alarm limit and a high alarm limit. Alarm limits can be set anywhere over the dynamic range of the signal. The range for each is -32768 to $+32767$. The high alarm limit must be greater than the low alarm limit. If alarm reporting is not wanted, alarm limits can be set beyond the dynamic range of the signal so they will never be activated.

After entering the Low Alarm Limit, press the F4 (enter) key. Then enter the High Alarm Limit for the channel.

```
S:4 CH1 AL H
32000
< > chg entr
```

That completes the configuration steps for one input channel on the 16-Point Grouped Analog Input module. Continue as described above to configure the rest of the inputs.

14. CONFIGURE AN 8-POINT GROUPED ANALOG VOLTAGE INPUT MODULE

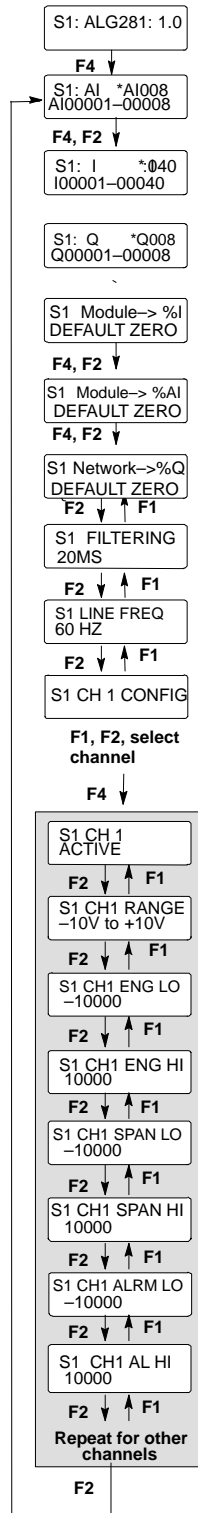

When you select “Read” from the empty slot HHM screen, this module screen appears:

```
S:2 ALG281 1.0
< > del zoom
```

14.1. Assign I/O References for the Module

When you “zoom” into the module’s slot, a screen like this appears:

```
S:2 AI *AI:008
AI01970-01977
< > chg entr
```

Default BIU data type

Default data length

Next available reference

This screen shows the default table and length and the next available reference address in that table for that reference parameter. The length is displayed in units that are appropriate for that data type (AI and AQ are in words, Q and I are in bits). The asterisk indicates that this reference has not yet been defined.

If the present selection is acceptable, press F4 (enter) to accept it. The asterisk will disappear.

If you prefer to change the BIU table mapping, length or reference value, press F3 (change).

```
S:2 AI AI
Select table
tgl entr
```

From this screen, you can display the other BIU data types by pressing F3 (toggle). Press F4 (enter) when the desired data type is displayed.

```
S:2 AI      AI:008
Select length
          clr entr
```

If you want to enter a different length for the displayed data type, press F3 (clear) to clear the length field. Enter the new length from the keypad. If you enter an invalid length, the HHM prompts: **BAD LENGTH ERR.**

After entering the correct length, the offset (starting reference) screen appears. The BIU automatically supplies the next available address in the selected table. You can press F4 (enter) to accept this value or F3 (clear) then enter a new value from the keypad. Press the F4 (enter) key after entering a new offset.

```
S:2 AI      AI:008
RefAddr 00114
< >      clr entr
```

The 8-Point Grouped Analog Voltage Input Module is an intelligent module, which uses more than one type of data. Use the F2 (>) key to display the screen for the module's discrete input diagnostic data.

```
S:2 I      * I:040
I01152-01191
< >      chg entr
```

You can edit this screen or accept it using the F4 (enter) key. The asterisk beside the data type disappears, to show that the current values have been saved.

```
S:2 I      I:040
I01152-01191
< >      chg entr
```

Next, go to the screen that shows the module's discrete output references, which are used for fault clearing.

```

S:2 Q   * Q:008
Q00916-00923
< >   chg entr

```

You can also edit this screen. Use the F4 (enter key) to save the selections and continue to the next item. Note that all required references for the module must be entered. You can give a reference parameter a length of zero if you do not want to map the data to the BIU. If you attempt to back out before the references are all configured, the HHM displays the following screen:

```

Cfgr Incomplete
Clear Slot?
      yes   no

```

If you exit, the references you have configured are not saved.

14.1.1. Configure Data Defaults

For data types AI and I, you can determine what the BIU should do with the module's data if the BIU loses communications with the module. Data can either be held at its present values or defaulted to zero.

You can accept DEFAULT: ZERO with the F4 (enter) key or press F3 (toggle) then F4 (enter) to change to DEFAULT: HOLD and save it.

```

S:2 Module-> %I
DEFAULT:ZERO
< >   tgl entr

```

```

S:2 Module-> %I
DEFAULT:HOLD
< >   tgl entr

```

```

S:2 Module-> %AI
DEFAULT:ZERO
< >   tgl entr

```

For data going to the module (type Q) which is included within the BIU's I/O map, you can determine what data the BIU will send to the module if the BIU loses communications with the network.

```
S:2 Network-> %Q
DEFAULT:ZERO
< > tgl entr
```

14.1.2. Configure Filtering

Next, select the filtering delay to eliminate noise due to the AC power lines. Filtering increases the response time to changes in a channel.

The choices for filtering are:

- A. None : The module returns the most recent sample of the input.
- B. 10 ms: The module averages the most recent 8 samples of the input.
- C. 20 ms: The module averages the most recent 16 samples of the input.

The module will perform filtering on all inputs on the module that are configured as "active".

```
S:2 FILTERING
20MS
< > tgl entr
```

1. If you want to change the displayed selection, press F3 (tgl).
2. Use the F4 (entr) key to save the selection.
3. Press F2 (>) to go to the next screen.

14.1.3. Configure the Line Frequency

Next, set the line frequency for the module. Select 50 or 60 Hz.

Disturbances due to AC noise cause variations around the desired DC level. The amplitude of these variations can be reduced by configuring the rate at which the module scans inputs for the operating frequency. If the line frequency is configured at 60 Hz, the module scans each input channel every 1.04 milliseconds. If the line frequency is configured at 50 Hz, the module scans each input channel every 1.25 ms.

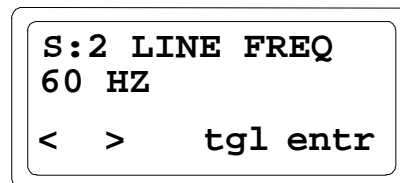

1. If you want to change the displayed selection, press F3 (tgl).
2. Use the F4 (entr) key to save the selection.
3. Press F2 (>) to go to the first circuit configuration screen.

14.2. Circuit Configuration

The sequence in which circuit configuration screens appear depends on the revision level of the Hand-Held Monitor and the BIU.

14.2.1. Channel Header

If the BIU and Hand-Held Monitor support display of channel headers, a header screen appears for each channel as shown below:

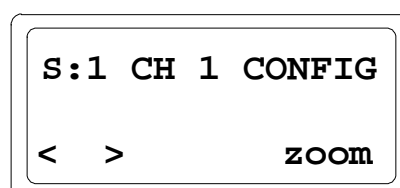

- A. Press F2 (>) from this screen to go to the header screen for the next channel. Pressing F2 (>) from channel 8 displays the module's first reference parameter screen.
- B. Press F1 (<) from this screen to go to the header screen for the previous channel. Pressing F1 (<) from channel 1 displays the module's last reference parameter screen.
- C. Press F4 (zoom) to go to the first configuration screen for the channel.
- D. When in a channel-specific configuration screen, press the up arrow/MENU key to go to that channel's header screen.

If the BIU and Hand-Held Monitor do not support display of channel headers, the header screens do not appear and keys F1 (<) and F2 (>) are used to scroll through channel-specific configuration screens.

The following features are configured for each channel.

14.2.2. Channel Active

When a channel is configured as Active, it is scanned for data and checked for errors. If a channel should not be scanned, that channel can be configured as inactive. An inactive input channel returns the value 0.

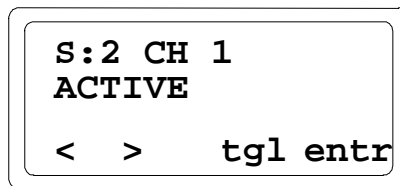

1. If you want to change the displayed selection, press F3 (tgl).
2. Use the F4 (entr) key to save the selection.
3. Press F2 (>) to go to the next screen.

14.2.3. Input Range

On this screen, specify the range for the input. There are two predetermined range and data scaling combinations.

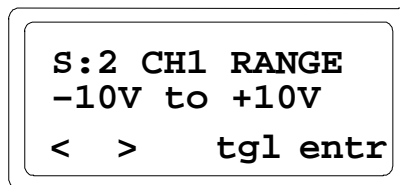

The default is -10V to +10V.

Selection	Input voltage (mV) = Data range
1	-10000 to 10000 = -10000 to 10000
2	0 to 10000 = 0 to 10000

14.2.4. Input Scaling

The 8-Point Grouped Analog Voltage Input Module performs its own scaling (unlike conventional CE80-20 analog modules, whose scaling is performed by the BIU).

Scaling can be used to define a linear relationship between a channel's input voltage in millivolts (mV) and the value in engineering units returned to the BIU. The default scaling configuration provides values from -10,000 to 10,000 for an input voltage range of -10V (low span value) to 10V (high span value).

To scale a channel, choose a high and low point and enter the actual input value (span) and a corresponding engineering units value for each. During operation, the module will use these values to convert input voltages into digital values that represent engineering units. Scaling does not increase the resolution of the data, but it does transform the values returned to the BIU into more convenient units.

If the scaled data falls below the minimum for engineering units, the module returns the minimum engineering units value (-32767). If the scaled data rises above the maximum for engineering units, the module returns the maximum engineering units value (32767).

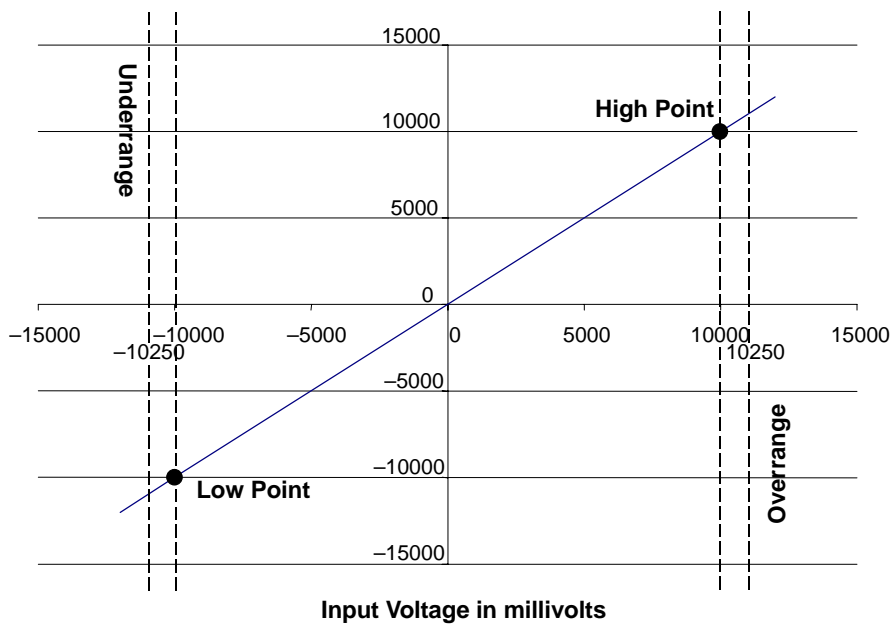

The illustration below shows the module's default scaling.

The first scaling screen shows the engineering units value that is considered equivalent to the low span (actual) value. Engineering units may be from -32767 to 32767.

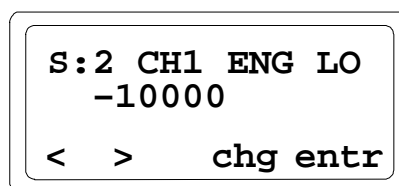

Enter the high span value for the channel. This is the actual voltage in millivolts to be scaled to the high engineering units value.

```
S:2 CH1 ENG HI
 10000
< >   chg entr
```

Next, enter the actual voltage in millivolts to be scaled to the low engineering units value.

```
S:2 CH1 SPAN LO
-10000
< >   chg entr
```

Span values are 8 signed integers ranging from -10,000 to 10,000. After entering the low span value for the input, press the F4 (enter) key. Enter a high span value for the same input.

```
S:2 CH1 SPAN HI
-10000
< >   chg entr
```

14.2.5. Alarm Limits

The next screen is used to set the low alarm limit for the channel in engineering units.

```
S:2 CH1 ALRM LO
-10000
< >   chg entr
```

Each input channel can have a low alarm limit and a high alarm limit. Alarm limits can be set anywhere over the dynamic range of the signal. The range for each is -32,767 to +32,767. The high alarm limit must be greater than the low alarm limit. If alarm reporting is not wanted, alarm limits can be set beyond the dynamic range of the signal so they will never be activated.

After entering the Low Alarm Limit, press the F4 (enter) key. Then enter the High Alarm Limit for the channel.

```
S:2 CH1 ALRM HI
10000
< > chg entr
```

That completes the configuration steps for one input channel on the 8-Point Grouped Analog Voltage Input module. Continue as described above to configure the rest of the inputs.

15. CONFIGURE A 16-POINT GROUPED ANALOG VOLTAGE INPUT MODULE

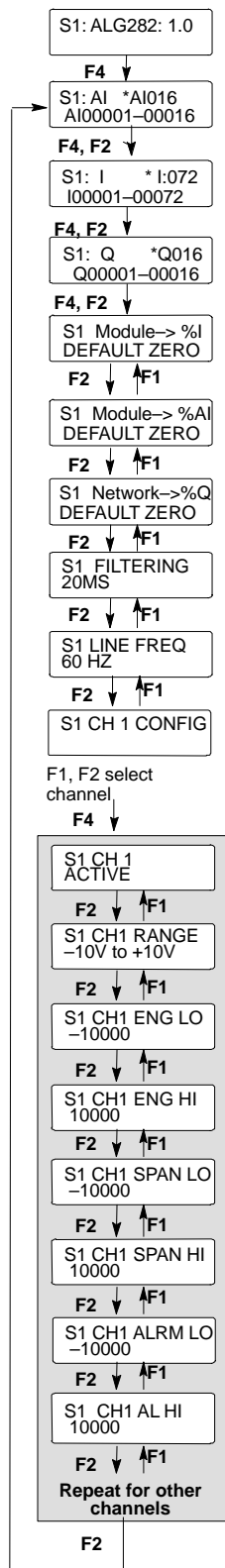

When you select “Read” from the empty slot HHM screen, this module screen appears:

```
S:2 ALG282 1.0
< > del zoom
```

15.1. Assign I/O References for the Module

When you “zoom” into the module’s slot, a screen like this appears:

```
S:2 AI *AI:016
AI01970-01985
< > chg entr
```

Default BIU data type

Default data length

Next available reference

This screen shows the default table and length and the next available reference address in that table for that reference parameter. The length is displayed in units that are appropriate for that data type (AI and AQ are in words, Q and I are in bits). The asterisk indicates that this reference has not yet been defined.

If the present selection is acceptable, press F4 (enter) to accept it. The asterisk will disappear. If you prefer to change the BIU table mapping, length or reference value, press F3 (change).

```
S:2 AI AI
Select table
tgl entr
```

From this screen, you can display the other BIU data types by pressing F3 (toggle). Press F4 (enter) when the desired data type is displayed.

```
S:2 AI AI:016
Select length
clr entr
```

If you want to enter a different length for the displayed data type, press F3 (clear) to clear the length field. Enter the new length from the keypad. If you enter an invalid length, the HHM prompts: **BAD LENGTH ERR.**

After entering the correct length, the offset (starting reference) screen appears. The BIU automatically supplies the next available address in the selected table. You can press F4 (enter) to accept this value or F3 (clear) then enter a new value from the keypad. Press the F4 (enter) key after entering a new offset.

```
S:2 AI      AI:016
Ref Addr 00114
< >      clr entr
```

The 16-Point Grouped Analog Voltage Input Module is an intelligent module, which uses more than one type of data. Use the F2 (>) key to display the screen for the module's discrete input diagnostic data.

```
S:2 I      * I:072
I01152-01223
< >      chg entr
```

You can edit this screen or accept it using the F4 (enter) key. The asterisk beside the data type disappears, to show that the current values have been saved.

```
S:2 I      I:072
I01152-01223
< >      chg entr
```

Next, go to the screen that shows the module's discrete output references, which are used for fault clearing.

```
S:2 Q      * Q:016
Q00916-00931
< >      chg entr
```

You can also edit this screen. Use the F4 (enter key) to save the selections and continue to the next item. Note that all required references for the module must be entered. You can give a reference parameter a length of zero if you do not want to map the data to the BIU. If you attempt to back out before the references are all configured, the HHM displays the following screen:

```
Cfg Incomplete
Clear Slot?
          yes  no
```

If you exit, the references you have configured are not saved

15.2. Configure Data Defaults

For data types AI and I, you can determine what the BIU should do with the module's data if the BIU loses communications with the module. Data can either be held at its present values or defaulted to zero.

You can accept DEFAULT: ZERO with the F4 (enter) key or press F3 (toggle) then F4 (enter) to change to DEFAULT: HOLD and save it.

```
S:2 Module-> %I
DEFAULT:ZERO
< > tgl entr
```

```
S:2 Module-> %I
DEFAULT:HOLD
< > tgl entr
```

```
S:2 Module-> %AI
DEFAULT:ZERO
< > tgl entr
```

For data going to the module (type Q) which is included within the BIU's I/O map, you can determine what data the BIU will send to the module if the BIU loses communications with the network.

```
S:2 Network-> %Q
DEFAULT:ZERO
< > tgl entr
```

15.3. Configure Filtering

Next, select the filtering delay to eliminate noise due to the AC power lines. Filtering increases the response time to changes in a channel.

The choices for filtering are:

- A. None: The module returns the most recent sample of the input.
- B. 10 ms: The module averages the most recent 8 samples of the input.
- C. 20 ms: The module averages the most recent 16 samples of the input.

The module will perform filtering on all inputs on the module that are configured as "active".

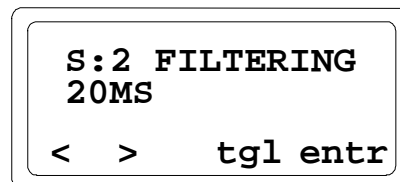

1. If you want to change the displayed selection, press F3 (tgl).
2. Use the F4 (entr) key to save the selection.
3. Press F2 (>) to go to the next screen.

15.4. Configure the Line Frequency

Next, set the line frequency for the module. Select 50 or 60 Hz.

Disturbances due to AC noise cause variations around the desired DC level. The amplitude of these variations can be reduced by configuring the rate at which the module scans inputs for the operating frequency. If the line frequency is configured at 60 Hz, the module scans each input channel every 1.04 milliseconds. If the line frequency is configured at 50 Hz, the module scans each input channel every 1.25 ms.

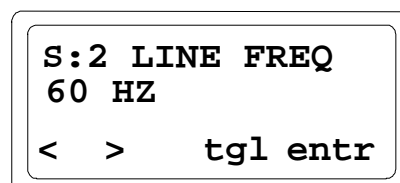

1. If you want to change the displayed selection, press F3 (tgl).
2. Use the F4 (entr) key to save the selection.
3. Press F2 (>) to go to the first circuit configuration screen.

15.5. Circuit Configuration

The sequence in which circuit configuration screens appear depends on the revision level of the Hand-Held Monitor and the BIU.

15.5.1. Channel Header

If the BIU and Hand-Held Monitor support display of channel headers, a header screen appears for each channel as shown below.

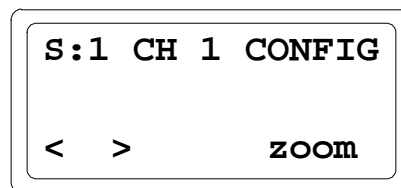

- A. Press F2 (>) from this screen to go to the header screen for the next channel. Pressing F2 (>) from channel 8 displays the module's first reference parameter screen.
- B. Press F1 (<) from this screen to go to the header screen for the previous channel. Pressing F1 (<) from channel 1 displays the module's last reference parameter screen.
- C. Press F4 (zoom) to go to the first configuration screen for the channel.
- D. When in a channel-specific configuration screen, press the up arrow/MENU key to go to that channel's header screen.

If the BIU and Hand-Held Monitor do not support display of channel headers, the header screens do not appear and keys F1 (<) and F2 (>) are used to scroll through channel-specific configuration screens.

The following features are configured for each channel.

15.5.2. Channel Active

When a channel is configured as Active, it is scanned for data and checked for errors. If a channel should not be scanned, that channel can be configured as inactive. An inactive input channel returns the value 0.

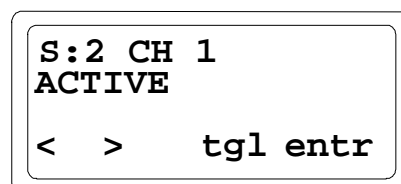

1. If you want to change the displayed selection, press F3 (tgl).
2. Use the F4 (entr) key to save the selection.
3. Press F2 (>) to go to the next screen.

15.5.3. Input Range

On this screen, specify the range for the input. There are two predetermined range and data scaling combinations.

```

S:2 CH1 RANGE
-10V to +10V
< > tgl entr

```

The default is -10V to +10 V.

Selection	Input voltage (mV) = Data range
1	-10000 to 10000 = -10000 to 10000
2	0 to 10000 = 0 to 10000

15.5.4. Input Scaling

The 16-Point Grouped Analog Voltage Input Module performs its own scaling (unlike conventional CE80-20 analog modules, whose scaling is performed by the BIU).

Scaling can be used to define a linear relationship between a channel's input voltage in millivolts (mV) and the value in engineering units returned to the BIU. The default scaling configuration provides values from -10,000 to 10,000 for an input voltage range of -10 V (low span value) to 10 V (high span value).

To scale a channel, choose a high and low point and enter the actual input value (span) and a corresponding engineering units value for each. During operation, the module will use these values to convert input voltages into digital values that represent engineering units. Scaling does not increase the resolution of the data, but it does transform the values returned to the BIU into more convenient units.

If the scaled data falls below the minimum for engineering units, the module returns the minimum engineering units value (-32767). If the scaled data rises above the maximum for engineering units, the module returns the maximum engineering units value (32767).

The illustration below shows the module's default scaling.

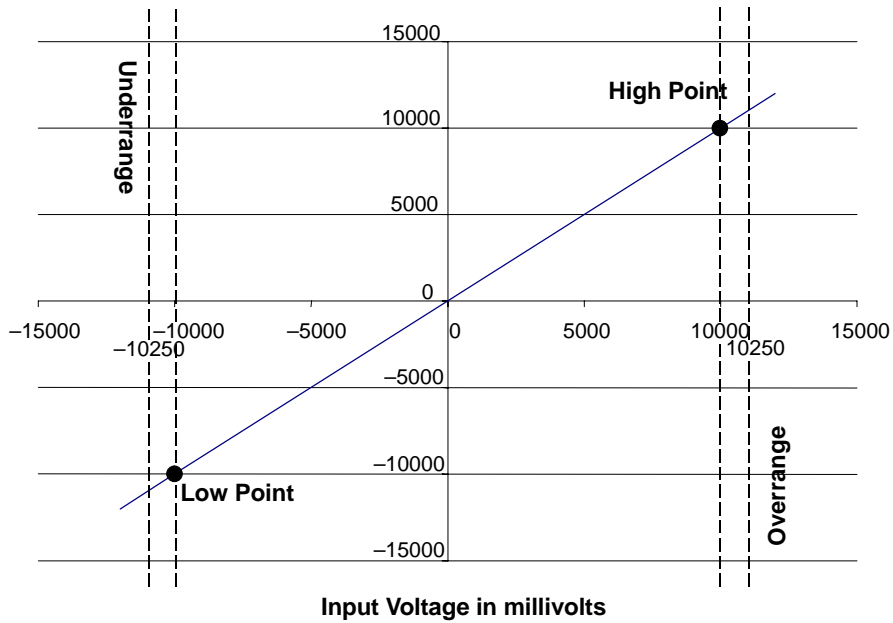

The first scaling screen shows the engineering units value that is considered equivalent to the low span (actual) value. Engineering units may be from -32767 to 32767.

```
S:2 CH1 ENG LO
-10000
< > chg entr
```

Enter the high span value for the channel. This is the actual voltage in millivolts to be scaled to the high engineering units value.

```
S:2 CH1 ENG HI
10000
< > chg entr
```

Next, enter the actual voltage in millivolts to be scaled to the low engineering units value.

```
S:2 CH1 SPAN LO
-10000
< > chg entr
```

Span values are 16 signed integers ranging from -10,000 to 10,000. After entering the low span value for the input, press the F4 (enter) key. Enter a high span value for the same input.

```
S:2 CH1 SPAN HI
-10000
< > chg entr
```

15.5.5. Alarm Limits

The next screen is used to set the low alarm limit for the channel in engineering units.

```
S:2 CH1 ALRM LO
-10000
< > chg entr
```

Each input channel can have a low alarm limit and a high alarm limit. Alarm limits can be set anywhere over the dynamic range of the signal. The range for each is -32,767 to +32,767. The high alarm limit must be greater than the low alarm limit. If alarm reporting is not wanted, alarm limits can be set beyond the dynamic range of the signal so they will never be activated.

After entering the Low Alarm Limit, press the F4 (enter) key. Then enter the High Alarm Limit for the channel.

```
S:2 CH1 ALRM HI
10000
< > chg entr
```

That completes the configuration steps for one input channel on the 16-Point Grouped Analog Voltage Input module. Continue as described above to configure the rest of the inputs.

16. CONFIGURE AN RTD INPUT MODULE

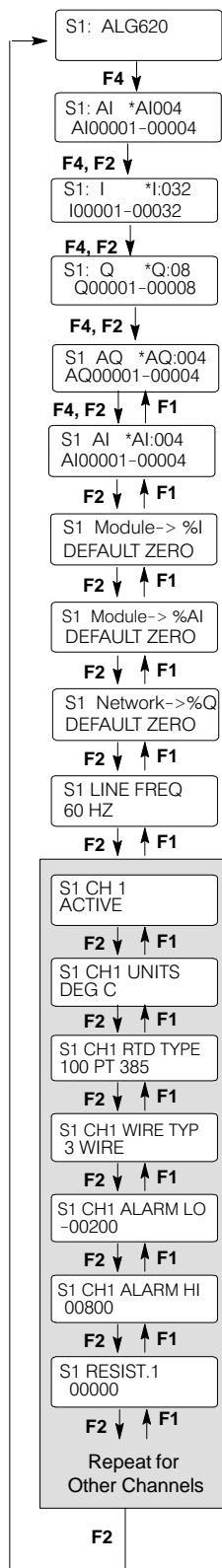

Follow the configuration steps below for the RTD module.

```
S:4 ALG620 *.*
< > del zoom
```

Module version

16.1. Assign I/O References for the Module

Press F4 to zoom into the slot. A screen like this appears:

```
S:4 AI *AI:004
AI01311-01314
< > chg entr
```

Number of references for this module type

This screen shows the default table and length and the next available reference address for that reference type. The length is displayed in appropriate units (AI and AQ in words, Q and I are bits). An asterisk indicates that the reference is not yet defined. If the present selection is acceptable, press F4 (enter) to accept it. The asterisk will disappear.

If you prefer to change the BIU table mapping, length or reference value, press F3 (change).

```
S:4 AI AI
Select table
chg entr
```

From this screen, you can display the other data types by pressing F3 (toggle). Press F4 (enter) when the desired data type is displayed.

```
S:4 AI AI:004
Select length
chg entr
```

If you want to enter a different length for the displayed data type, press F3 (clear) to clear the length field. Enter the new length from the keypad. If you enter an invalid length, the HHM prompts: **BAD LENGTH ERR.** After “entering” the correct length, the offset (starting reference) screen appears. The BIU automatically supplies the next available address in the selected table.

You can press F4 (enter) to accept this value or F3 (clear) then enter a new value from the keypad. Press the F4 (enter) key after entering a new offset.

```
S:4 AI    AI:004
Ref Addr 01896

      clr entr
```

Use the F2 (>) key to display the screen for the module’s discrete input diagnostic data.

```
S:4 I    * I:032
I01817-01904

< >    chg entr
```

You can edit this screen or accept it using the F4 (enter) key. After you press the Enter key, the asterisk disappears to show that the current values have been saved. Next, press F2 to go to the screen that shows the module’s Q references, which are for fault clearing.

```
S:4 Q    * Q:008
Q01817-01832

< >    chg entr
```

You can also edit this screen. Use the F4 (enter key) to save the selections. Press F2 to continue to the next item. The next screen displays AQ references for the module. Enter a length of 0. Use the F4 (enter) key to save and continue.

```
S:4 AQ    AQ:004
AQ01057-01060

< >    chg entr
```

All required references for the module must be entered. You can give a reference parameter a length of zero if you do not want to map the data to the BIU. If you attempt to back out before the references are all configured, the HHM displays the following screen:

```
Cfg Incomplete
Clear slot?

      yes no
```

If you exit from this display, the references you have configured are not saved.

16.2. Assign Data Defaults

For data types AI and I, you can determine what the BIU should do with the module's data if the BIU loses communications with the module. Data can either be held at its present values or defaulted to zero.

You can accept DEFAULT: ZERO with the F4 (enter) key or press F3 (toggle) then F4 (enter) to change to DEFAULT: HOLD and save it.

I data is diagnostic data sent by the module.

```
S:4 Module-> %I
DEFAULT:ZERO
< >      tgl entr
```

AI data is RTD input data sent by the module.

```
S:4 Module-> %AI
DEFAULT:ZERO
< >      tgl entr
```

For command data going to the module (data types Q and AQ) which is included within the BIU's I/O map, you can determine what data the BIU will send to the module if the BIU loses communications with the network.

```
S:4 Network-> %Q
DEFAULT:ZERO
< >      tgl entr
```

16.3. Line Frequency

Next, set the line frequency for the module. Select 50 or 60 Hz.

```
S:1 LINE FREQ
60 HZ

< >      tgl entr
```

16.4. Circuit Configuration

The sequence in which circuit configuration screens appear depends on the revision level of the module, the Hand-Held Monitor and the BIU.

16.4.1. Channel Header

For module version IC670ALG620, version 1.4 or later, if the BIU and Hand-Held Monitor support display of channel headers, a header screen appears for each channel as shown below.

```
S:1 CH 1 CONFIG

< >      zoom
```

- A. Press F2 (>) from this screen to go to the header screen for the next channel. Pressing F2 (>) from channel 8 displays the module's first reference parameter screen.
- B. Press F1 (<) from this screen to go to the header screen for the previous channel. Pressing F1 (<) from channel 1 displays the module's last reference parameter screen.
- C. Press F4 (zoom) to go to the first configuration screen for the channel.
- D. When in a channel-specific configuration screen, press the up arrow/MENU key to go to that channel's header screen.

If the BIU and Hand-Held Monitor do not support display of channel headers, the header screens do not appear and keys F1 (<) and F2 (>) are used to scroll through channel-specific configuration screens.

The following features are configured for each channel.

16.4.2. Channel Active

```
S:4 CH 1
ACTIVE
< >    tgl entr
```

When a channel is configured as Active, it is scanned for data and checked for errors. If a channel should not be scanned, that channel can be configured as inactive. An inactive input channel returns the value 0.

1. If you want to change the displayed selection, press F3 (Tgl).
2. Use the F4 (entr) key to save the selection.
3. Press F2 (>) to go to the next screen.

16.4.3. Units

Next, select the conversion type for each RTD: tenths of degrees Fahrenheit, tenths of degrees Celsius or tenths of Ohms.

```
S:1 CH1 UNITS
DEG C
< >    tgl entr
```

1. Press F3 (toggle) if you want to change the displayed type of units.
2. Use the F4 (enter) key to save the selections on this screen and go on to the next item.

16.4.4. Units' Ranges

The following table shows the ranges for the types of units configured on this screen. Notice that Tenths of Ohms units are unsigned.

Units Selected	Integer Ranges	Engineering Units Ranges
(Tenths of) Degrees (F or C)	-32767 to +32767	-3276.7 to +3276.7
(Tenths of) Ohms	0 to 65535	0 Ohms to 6553.5 Ohms

16.5. RTD Type

Select the RTD type that most closely matches the RTD used on that channel. The table below has more information about RTD categories.

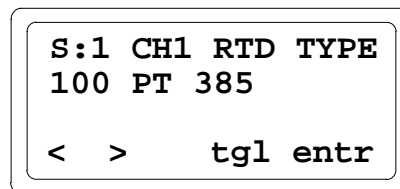

1. Use the F3 (toggle) key if you want to change the displayed RTD type.
2. Use the F4 (enter) key to save the selections on this screen and go on to the next item.

Selection	Comments	Selection	Comments	Selection	Comments
10 PT	10 Ohm Platinum (PT)	100 PT 3916	100 Ohm Platinum, $\alpha=0.003916$	100 NI 618	100 Ohm Nickel At 0°C, DIN43760, $\alpha=0.00618$
25 PT	25 Ohm Platinum IPTS-68	1K PT 375	1 KOhm Platinum, $\alpha=0.00375$	120 NI 672	120 Ohm Nickel, at 0°C, $\alpha=0.00672$
25.5 PT 392	25.5 Ohm Platinum, $\alpha=0.00392$ at 0°C Lab Std	10 CU	10 Ohm Copper, at 25°C, IPTS-68	604 NI/FE 518	604 Ohm Nickel/Iron, at 0°C, $\alpha=0.00518$
100 PT 385	100 Ohm Platinum, DIN43760, $\alpha=0.00385$	9.035 CU 427	9.035 Ohm Copper, at 25°C, $\alpha=0.00427$	1K NI/FE 527	1 KOhm Nickel/Iron, at 70°F, $\alpha=0.00527$
100 PT 3902	100 Ohm Platinum, $\alpha=0.003902$	50 CU 427	50 Ohm Copper, $\alpha=0.00427$	500 OHM	Select UNITS of 1/10 Ohms
100 PT 392	100 Ohm Platinum, $\alpha=0.00392$ IPTS-6 8	100 CU 427	100 Ohm Copper, $\alpha=0.00427$	3000 OHM	Select UNITS of 1/10 Ohms
100PT 3923	98.13 Ohm Platinum, $\alpha=0.003923$	100 NI	100 Ohm Nickel, IPTS-68		

16.6. Wire Type

Next, specify the type of field wiring present at the terminal board connectors for each RTD. The choices are 3 WIRE and 4 WIRE.

```
S:1 CH1 WIRE TYP
3 WIRE
< >   tgl entr
```

1. Use the F3 (toggle) key if you want to change the displayed RTD Wire type.
2. Use the F4 (enter) key to save the selections on this screen and go on to the next item.

16.7. Low Alarm Limit

Next, set the low alarm limit for the RTD. The range is -32767 to $+32767$.

Each RTD channel can have a low alarm limit and a high alarm limit. Alarms do not stop the process or change the value of the input.

Alarm limits can be set anywhere over the dynamic range of the signal. If alarm reporting is not wanted, alarm limits can be set beyond the dynamic range of the signal so they will never be activated.

The units used for alarm limits are the same type entered on the Units screen (tenths of Ohms or tenths of degrees Celsius or Fahrenheit). If units are subsequently changed, alarm limits should be reviewed and adjusted if necessary.

```
S:1 CH1 ALARM LO
-200
< >   chg entr
```

1. Use the F3 (change) key if you want to change the Low Alarm Limit and enter the new value.
2. Use the F4 (enter) key to save the selections on this screen and go on to the next item.

16.8. High Alarm Limit

Next, set the high alarm limit for an RTD. The range is -32767 to $+32767$. The high alarm limit must be greater than the low alarm limit.

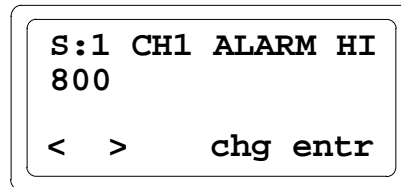

1. Use the F3 (change) key if you want to change the High Alarm Limit and enter the new value.
2. Use the F4 (enter) key to save the selections on this screen and go on to the next item.

16.9. Resistance

The RTD Resistance is a resistance adjustment that can change the Ohms value of an input. Its use is optional. The range is 0 to 3276.7.

The value is entered and displayed in tenths of Ohms.

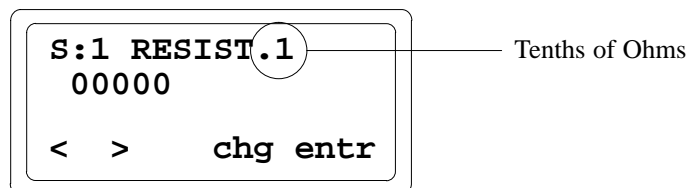

The resistance value is used to correct for RTD values that are not at the nominal value. For example, if a 100 Ohm platinum RTD is being used and it measures 99 Ohms at 25°C instead of the nominal 100 Ohms at 25°C , the value 990 should be entered here to correct the temperature readings.

1. Use the F3 (change) key if you want to change the RTD Resistance.
2. Enter the new value in tenths of ohms.
3. Use the F4 (enter) key to save the selections on this screen and go on to the next channel.

RTD Resistance specifications are available from the RTD manufacturer or may be determined by actual measurement.

RTD Type	Low Ω Limit	High Ω Limit	Low Temp. °C	High Temp. °C
10 Ohm Copper at 25°C	6.13600	14.8200	-75.00	150.00
10 Ohm Platinum at 25°C	7.02000	37.2599	-70.00	1000.00
25 Ohm Platinum	4.14500	74.3089	-201.1111	537.77
100 Ohm Nickel	80.88890	147.7700	-40.00	140.00
1 KOhm Platinum, $\alpha= 0.00375$	199.4880	2754.620	-200.00	500.00
100 Ohm Platinum $\alpha=0.00385$	27.01	389.936	-180.0	850.0
100 Ohm Platinum, $\alpha=0.003902$	93.5400	135.000	-17.7777	99.9999
100 Ohm Platinum IPTS68 (PA)	26.5	327.744	-200.0	630.0
100 Ohm Platinum SAMA-RC21-4 (PC)	26.5	311.874	-200.0	600.0
100 Ohm Platinum JISC-1604-'81	26.5	323.780	-200.0	620.0
25.5 Ohm Platinum Lab Std (PJ)	4.50	83.575	-200.0	630.0
9.035 Ohm Copper (CA)	6.05	16.400	-100.0	260.0
50 Ohm Copper (CB/2)	28.379	105.787	-100.0	260.0
100 Ohm Copper (CB)	56.757	211.574	-100.0	260.0
100 Ohm Nickel (NB)	69.520	223.221	-60.0	180.0
120 Ohm Nickel (NA)	66.600	380.310	-80.0	260.0
604 Ohm Nickel/Iron (FA)	372.789	1318.722	-100.0	204.0
1 KOhm Nickel/Iron (FB)	566.576	1985.891	-100.0	204.0

17. CONFIGURE A THERMOCOUPLE INPUT MODULE

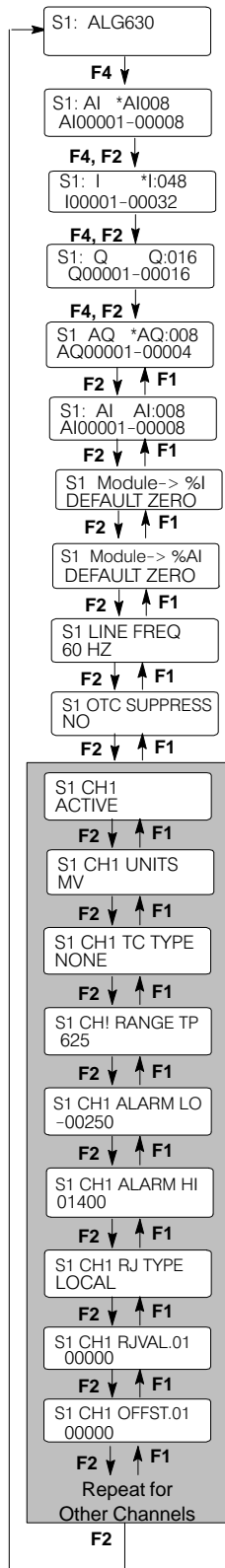

When you select “Read” from the empty slot HHM screen, this module screen appears:

```
S:4 ALG630 *.*
< > del zoom
```

17.1. Assign I/O References for the Module

Press F4 to zoom into the slot. A screen like this appears:

```
S:4 AI *AI:008
AI00009-00016
< > chg entr
```

Number of references for this module type

This screen shows the default table and length and the next available reference address for that reference type. The length is displayed in appropriate units (AI and AQ in words, Q and I are bits). The asterisk indicates that the reference is not yet defined. If the present selection is acceptable, press F4 (enter) to accept it. The asterisk will disappear.

If you prefer to change the BIU table mapping, length or reference value, press F3 (change).

```
S:4 AI AI
Select table
tgl entr
```

From this screen, you can display the other data types by pressing F3 (toggle). Press F4 (enter) when the desired data type is displayed.

```
S:4 AI AI:008
Select length
clr entr
```

If you want to enter a different length for the displayed data type, press F3 (clear) to clear the length field. Enter the new length from the keypad. If you enter an invalid length, the HHM prompts: **BAD LENGTH ERR.** After “entering” the correct length, the offset (starting reference) screen appears. The BIU automatically supplies the next available address in the selected table.

You can press F4 (enter) to accept this value or F3 (clear) then enter a new value from the keypad. Press the F4 (enter) key after entering a new offset.

```
S:4 AI      AI:008
Ref Addr 01896

      clr entr
```

Use the F2 (>) key to display the screen for the module’s discrete input diagnostic data.

```
S:4 I      * I:048
I01801-01848

< >      chg entr
```

You can edit this screen or accept it using the F4 (enter) key. After you press the Enter key, the asterisk disappears to show that the current values have been saved. Next, go to the screen that shows the module’s Q references, which are for fault clearing.

```
S:4 Q      * Q:016
Q01801-01816

< >      chg entr
```

You can also edit this screen. Use the F4 (enter key) to save the selections and continue to the next item. The next screen displays the AQ reference for the module. You can edit the address and length. This one-word reference is used only if a remote compensation value will be supplied to the module by the BIU. (“Remote” must be configured as the RJ Type). For all other RJ Types, enter a length of 0. Use the F4 (enter) key to save and continue.

```
S:4 AQ      AQ:001
AQ01057-01058

< >      chg entr
```

All required references for the module must be entered. You can give a reference parameter a length of zero if you do not want to map the data to the BIU. If you attempt to back out before the references are all configured, the HHM displays the following screen:

```

Cfg Incomplete
Clear Slot?

      yes  no
  
```

If you exit from this display, the references you have configured are not saved.

17.2. Assign Data Defaults

For input data types AI and I, you can determine what the BIU should do with the module's data if the BIU loses communications with the module. Data can either be held at its present values or defaulted to zero.

You can accept DEFAULT: ZERO with the F4 (enter) key or press F3 (toggle) then F4 (enter) to change to DEFAULT: HOLD and save it.

Discrete input (I) data is diagnostic data sent by the module.

```

S:4 Module-> %I
DEFAULT:ZERO

< >    tgl entr
  
```

Analog input (AI) data is input data sent by the module.

```

S:4 Module-> %AI
DEFAULT:ZERO

< >    tgl entr
  
```

For command data going to the module (data types Q and AQ) which is included within the BIU's I/O map, you can determine what data the BIU will send to the module if the BIU loses communications with the network.

```

S:4 Network-> %Q
DEFAULT:ZERO

< >    tgl entr
  
```

```

S:4 Network->%AQ
DEFAULT:ZERO

< >    tgl entr
  
```

17.3. Line Frequency

Next, set the line frequency for the module. Select 50 or 60 Hz.

```
S:1 LINE FREQ
60 HZ

< >    tgl entr
```

17.4. Suppress Open Thermocouple Diagnostic

```
S:4 OTC SUPPRESS
NO

< >    tgl entr
```

Configure whether the module should perform Open Thermocouple diagnostics on the input data.

1. Select NO (the default) if the module should perform Open Thermocouple diagnostics. Select YES if it should not.
2. Use the F4 (enter) key to save the selections on this screen and go on to the next item.

17.5. Circuit Configuration

The following features are configured for each channel in turn.

17.5.1. Channel Active

```
S:4 CH 1
ACTIVE

< >    tgl entr
```

When a channel is configured as Active, it is scanned for data and checked for errors. If a channel should not be scanned, that channel can be configured as inactive. An inactive input channel returns the value 0.

1. If you want to change the displayed selection, press F3 (Tgl).
2. Use the F4 (entr) key to save the selection.
3. Press F2 (>) to go to the next screen.

17.5.2. Engineering Units

Specify whether the module should report values for the input as hundredths of millivolts or as tenths of degrees C or F.

```
S:1 CH1 UNITS
MV
< > tgl entr
```

1. Use the F3 (tgl) key if you want to change the current choice.
2. Use the F4 (enter) key to save the selection.

17.5.3. Thermocouple Type

Next, specify the type of Thermocouple present on the channel: J, K, T, E, S, R, B, N, G, C, D or Platinel II. The default is NONE. If this default is selected, the module will report inputs as millivolts.

```
S:1 CH1 TC TYPE
NONE
< > tgl entr
```

Note

If you selected Engineering Units of millivolts on the previous screen, the TC Type should be NONE.

1. Use the F3 (toggle) key if you want to change the displayed thermocouple type.
2. Use the F4 (enter) key to save the selection.

TC Type	Low mV Limit	High mV Limit	Low Temperature Limit (C)	High Temperature Limit (C)
J	-8.0960	57.9420	-210.00	1000.00
K	-5.8910	54.8069	-200.00	1370.00
T	-5.6030	20.2520	-200.00	390.00
E	-8.8240	76.3580	-200.00	1000.00
S	-0.1940	18.5040	-40.00	1750.00
R	-0.1880	20.8780	-40.00	1750.00
B	0.03300	13.8140	100.00	1820.00
N	-0.57480	47.5019	-22.222	1300.00
G	-0.00600	38.5639	4.444	2315.55
C	0.23400	37.0660	-17.7777	2315.55
D	-0.16300	39.5060	-17.7777	2315.55
Platinel II	0.0000	52.25	0.00	1300.00

17.5.4. Range Type

If None was configured for Thermocouple Type, specify the range for millivolt inputs. The number displayed represents a +/- span of millivolts. For example, 19.5 represents +/-19.53 millivolts. The choices are: unused, 19.5 mV, 39 mV, 78.125 mV, 156.25 mV, 312.5 mV and 625 mV. The default is 625.

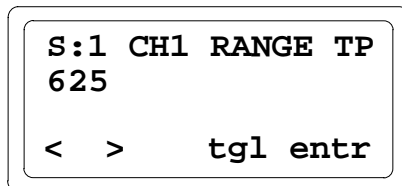

1. Use the F3 (toggle) key if you want to change the displayed thermocouple range.
2. Use the F4 (enter) key to save the selection and go on to the next item.

Note

If you selected Engineering Units of millivolts, be sure to configure alarm limits (see next page) within the Range selected here.

17.5.5. Low Alarm Limit

Next, set the low alarm limit for the input. The range is -32767 to +32767.

Each thermocouple channel can have a low alarm limit and a high alarm limit. If an input reaches one of its limits, the module reports the actual value and a LOW ALARM or HIGH ALARM message. The message identifies the circuit in alarm. Only one message is sent upon reaching the limit. Alarms do not stop the process or change the value of the input.

Alarm limits can be set anywhere over the dynamic range of the signal. If alarm reporting is not wanted, alarm limits can be set beyond the dynamic range of the signal so they will never be activated.

The units used for alarm limits are the same type entered on the Units screen (hundredths of millivolts or tenths of degrees Celsius or Fahrenheit). If units are subsequently changed, alarm limits should be reviewed and adjusted if necessary.

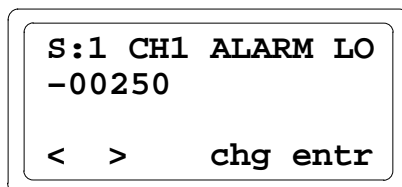

1. Use the F3 (change) key if you want to change the Low Alarm Limit and enter the new value.
2. Use the F4 (enter) key to save the selections on this screen and go on to the next item.

17.5.6. High Alarm Limit

Next, set the high alarm limit for a thermocouple. The range is -32767 to $+32767$. The high alarm limit must be greater than the low alarm limit.

```

S:1 CH1 ALARM HI
01400

< >   chg entr

```

1. Use the F3 (change) key if you want to change the High Alarm Limit and enter the new value.
2. Use the F4 (enter) key to save the selections on this screen and go on to the next item.

17.5.7. Reference Junction Compensation

Specify how or whether the channel will perform cold junction compensation. The choices are Local, Remote, Fixed and None. The default is Local.

```

S:1 CH1 RJ TYPE
LOCAL

< >   tgl entr

```

Select Local if cold junction compensation will be provided for locally-terminated thermocouples using a locally-mounted thermistor (either as part of a Thermocouple Terminal Block (catalog number IC670CHS004), as described in the Installation Instructions or connected directly to the A and B terminals of the I/O Terminal Block on which the module is installed).

Select Remote if the module will receive a cold junction compensation value from the controller, via the BIU, as analog output (AQ) data. The value is in degrees C and includes 2 decimal places.

Select Fixed if you want to configure a specific reference value (on a later screen). The fixed value is configurable on a per channel basis.

Select None for measuring millivolt inputs or if cold junction will be maintained at zero degrees C.

1. Use the F3 (toggle) key if you want to change the displayed Reference Junction type.
2. Use the F4 (enter) key to save the selection and go on to the next item.

17.5.8. Reference Junction Value

If you selected Fixed for RJ (Reference Junction) Type, enter the fixed value here. The 0.01 in the display is a reminder that the value entered includes tenths and hundredths. For example, you would enter 5522 to specify a value of 55.22 millivolts. The fixed value is added to the input millivolt value before linearization occurs. The fixed value should be obtained from a table for the appropriate thermocouple type.

```
S:1 CH1 RJVAL.01
00000
< > chg entr
```

1. Use the F3 (change) key if you want to change the value and enter the new value.
2. Use the F4 (enter) key to save the selections on this screen and go on to the next item.

17.5.9. Offset

The last selection for each channel is Offset. This parameter is normally left at zero.

The Offset is an optional fixed value that can be used to adjust for differences in thermocouples when the configured engineering units are either degrees C or degrees F. For example, if a thermocouple reads 25.3 degrees C when the actual temperature is known to be 25.0 degrees C, a value of -30 would be entered to cause the thermocouple to read 25.0 degrees.

The value contains two decimal places and should be supplied in the units specified by the Range Type. The value is applied before high and low alarm checks.

```
S:1 CH1 OFFST.01
00000
< > chg entr
```

1. Use the F3 (change) key if you want to change the Offset and enter the new value.
2. Use the F4 (enter) key to save the selections on this screen and go on to the next item.

17.5.10. Configure the Next Channel

Continue to configure the next channel in the same manner.

18. CONFIGURE AN 8-POINT ANALOG VOLTAGE OUTPUT MODULE

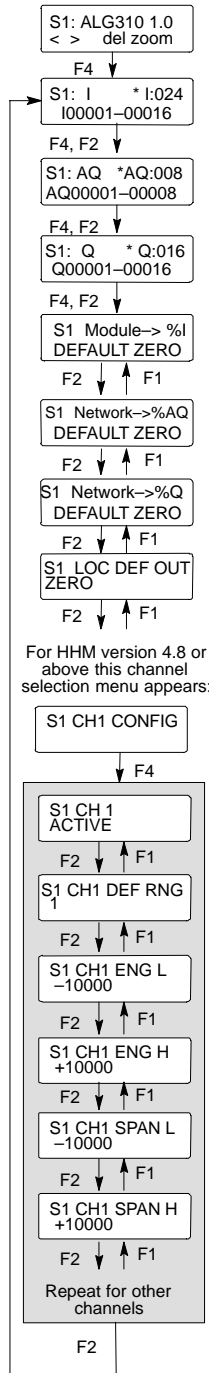

For HHM version 4.8 or above press F1 from Channel Active screen or Up Menu key to go to Channel Config screen.

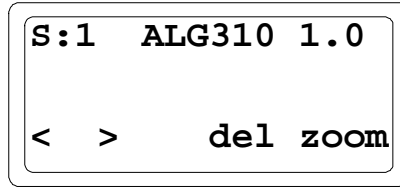

18.1. Assign I/O References for the Module

When you "zoom" into the module's slot, a screen like this appears:

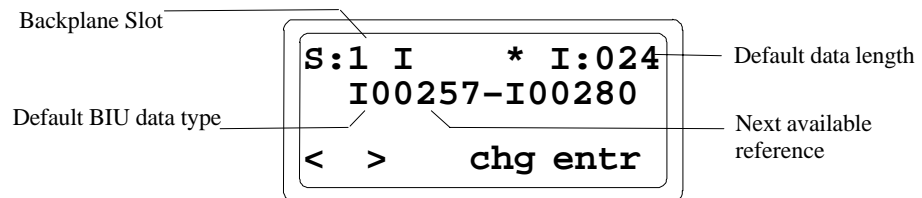

This I/O reference assignment screen shows the length and the next available reference address for each data type in BIU memory.

The 8-Point Analog Current Output Module is an intelligent module that uses more than one type of data.

- up to 8 words of analog output data (data type AQ on the Hand-Held Monitor),
- 0-4 bytes of discrete input data (data type I) for module and channel status. Use of this data is optional,
- 0-2 bytes of discrete output data (data type Q) for clearing alarms. Use of this data is optional.

The length is displayed in units that are appropriate for the data type (analog output data is in words, discrete inputs and outputs are in bits). The asterisk indicates that the reference has not yet been defined.

The first screen shows references for discrete input (I) diagnostic data. You can display the other BIU data types by pressing F3 (toggle). Press F4 (enter) when the desired data type is displayed.

If the starting reference and length for the data type are acceptable, press F4 (enter) to accept them. The asterisk will disappear.

If you prefer to change the BIU table mapping, length or reference value, press F3 (change). Then press F3 to select a data table (data type).

```
S:1 I      I
Select table

      tgl entr
```

To configure the selected data type, press F4 (entr). You can edit the length on this screen.

```
S:1 I      I:024
Select length

      clr entr
```

Enter the new length from the keypad. Valid values are:

- | | |
|-----------------------|---|
| 0, 8, 16 or 24 (bits) | for discrete input (data type I) data. |
| 0, 8 or 16 bits | for discrete output (data type Q) data. |
| up to 8 words | for analog output (data type AQ) data. |

If you enter a length of zero, the HHM displays **Unassigned** for that data type.

If you enter an invalid length, the HHM prompts: **BAD LENGTH ERR**. Data must be contained within byte boundaries; entries for length and reference address are automatically adjusted if needed. Lengths are adjusted down and reference addresses are adjusted down. For example, a length of 18 would be decreased to 16 and a starting address of 5 would be decreased to 1.

After entering a valid length, the offset (starting reference address) screen appears. The BIU automatically supplies the next available address for the selected data type. You can press F4 (enter) to accept the default value or enter a new value from the keypad. Press the F4 (enter) key after entering a new offset.

```
S:1 I      I:024
Ref Addr 00481

< >      clr entr
```

Module reference addresses for each data type must be greater than or equal to the starting addresses listed in the BIU map. If you enter an invalid address, the HHM prompts: **BAD REF ADDRESS**.

Use the F2 (>) key to display the screen for the module's analog output data.

```
S:1 AQ      *AQ:008
AQ00025-00032

< >      chg entr
```

You can edit this screen or accept it using the F4 (enter) key. The asterisk beside the data type disappears, to show that the current values have been saved. Valid values for analog output data length are 0–8. If this length is set to less than 8 and the module has not been previously configured the outputs of unused channels will go to 0 mV. However, if the module has been configured previously and is reconfigured to use fewer channels, the channels that are "removed" will continue to output voltage at their previously-configured levels until the module is reset.

```

S:1 AQ    AQ:008
AQ00025-00032
< >    chg entr

```

Pressing F2 (>) moves you to the screen that shows the module's discrete output bits, which can be used by the host for clearing faults. Valid lengths for this data type are 0–16. The data must lie on byte boundaries; entered lengths and reference addresses are automatically adjusted if necessary.

```

S:1 Q    * Q:016
Q01817-01832
< >    chg entr

```

Edit the reference address and length if needed. Press F4 (enter) to save the selections.

Entries must be made for data types I, Q and AQ. If you do not want to use one of these data types, give it a length of zero.

If you back out before all data types have been configured, the HHM displays the following screen:

```

Cfg Incomplete
Clear Slot?
      yes   no

```

If you exit, the I/O configuration choices are not saved.

The BIU will not send commands to the module until all three data types (I, Q and AQ) have been configured.

18.1.1. Configure Data Defaults

Data default screens are displayed next. For the module's diagnostic input bits (data type I), you can determine what the BIU should do with the data if the BIU loses communications with the module. Data can either be held at its present values or defaulted to zero.

```
S:1 Module-> %I
DEFAULT:ZERO
< >      tgl entr
```

You can accept DEFAULT: ZERO with the F4 (enter) key or press F3 (toggle) then F4 (enter) to change the default and save it.

```
S:1 Module-> %I
DEFAULT:HOLD
< >      tgl entr
```

For the module's fault clearing discrete output bits (AQ and Q) you can determine what data the BIU will send to the module if the BIU loses communications with the network. Selectable values are ZERO and HOLD.

```
S:1 Network->%AQ
DEFAULT:ZERO
< >      tgl entr
```

```
S:1 Network- %Q
DEFAULT:ZERO
< >      tgl entr
```

In an I/O station that includes local I/O control, some or all of the module's outputs may be assigned to addresses that are not within the BIU's I/O map. The defaults configured here do NOT apply to module outputs that are outside the BIU's I/O map

18.1.2. Configure Local Default Outputs

Next, select the default output mode used for all channels in the event of a local (module) failure or reset.

This is not the same as the data defaults described on the previous page, which are for the BIU.

The choices for local default output are:

- A. **ZERO**: The output of each channel goes to 0mV in the event of a local failure or reset.
- B. **HOLD LAST**: The output of each channel is held at the last value latched by the D/A converters in the event of a local failure or reset (provided the appropriate user power supply is present).

```
S:1 LOC DEF OUT
ZERO
< >    tgl entr
```

1. If you want to change the displayed selection, press F3 (Tgl).
2. Use the F4 (entr) key to save the selection.
3. Press F2 (>) to go to the next screen.

18.2. Circuit Configuration

The sequence in which circuit configuration screens appear depends on the revision level of the Hand-Held Monitor and the BIU.

18.2.1. Channel Header

If the BIU and Hand-Held Monitor support display of channel headers, a header screen appears for each channel as shown below.

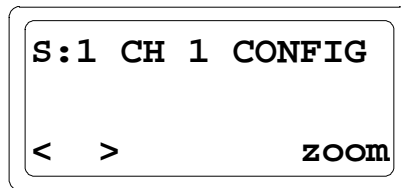

- A. Press F2 (>) from this screen to go to the header screen for the next channel. Pressing F2 (>) from channel 8 displays the module's first reference parameter screen.
- B. Press F1 (<) from this screen to go to the header screen for the previous channel. Pressing F1 (<) from channel 1 displays the module's last reference parameter screen.
- C. Press F4 (zoom) to go to the first configuration screen for the channel.
- D. When in a channel-specific configuration screen, press the up arrow/MENU key to go to that channel's header screen.

If the BIU and Hand-Held Monitor do not support display of channel headers, the header screens do not appear and keys F1 (<) and F2 (>) are used to scroll through channel-specific configuration screens.

The following features are configured for each channel.

18.2.2. Channel Active

When a channel is configured as Active, its analog output data is processed and its alarm conditions are returned. When a channel is configured as Inactive, its output goes to 0mV and its alarm conditions are not returned although any alarms that were already set can still be cleared using discrete output (Q) data.

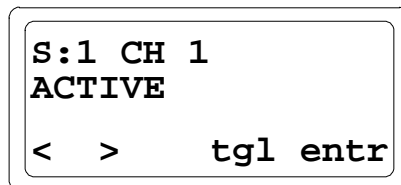

- 1. If you want to change the displayed selection, press F3 (Tgl).
- 2. Use the F4 (entr) key to save the selection.
- 3. Press F2 (>) to go to the next screen.

18.2.3. Scaling Range

Scaling can be used to define a constant-slope mapping from the value in engineering units sent by the BIU to a channel's output voltage. The default scaling configuration (-10V to +10V) provides an output voltage range of -10,000 (low span value) to +10,000 (high span value) for engineering units (AI) values of -10,000 to +10,000.

On this screen, specify the default range used for scaling analog output data. There are two predetermined range and data scaling combinations (-10V to +10V and 0V to +10V).

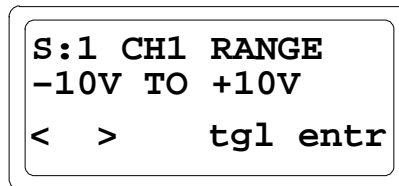

The default is -10V to +10V, which provides negative/positive scaled values. For positive values only, select 0V to +10V. Note that if the 0V to +10V range is used, the module will *not* report underrange faults during operation.

For either selection, you can use the default scaling parameters or enter different ones on the scaling screens.

Selection	Data Range = Output Voltage (mV)
-10V to +10V	-10,000 to +10,000 = -10,000 to +10,000
0V to +10V	0 to +10,000 = 0 to +10,000

The illustration below shows the default relationship between span values and digital to analog counts.

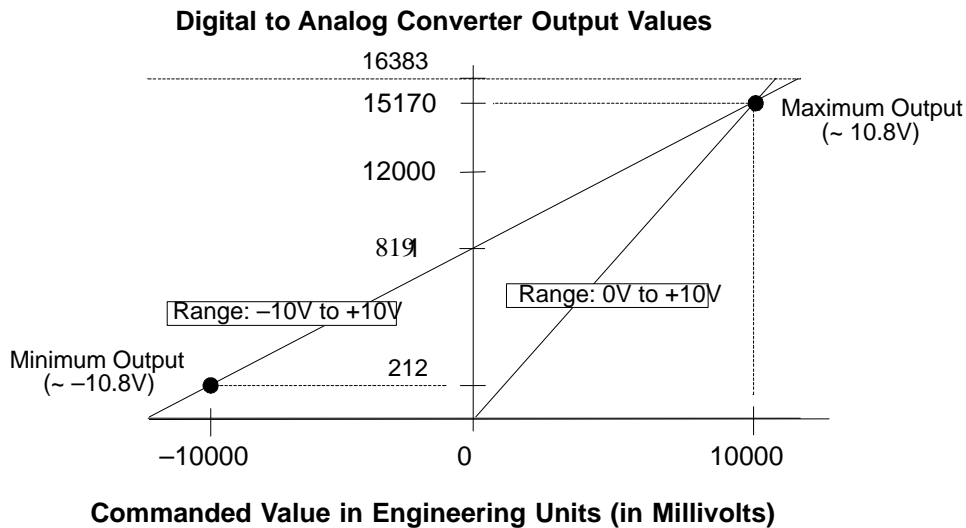

18.2.3.1. Custom Scaling

To scale a channel, choose a high and low point and enter the actual input value (span) and a corresponding engineering units value for each point. During operation, the module will use these values to convert engineering units into digital values that represent output voltage. Engineering units values are 16-bit signed integers from -32,768 to 32,767. Span values are signed integers ranging from -10,000 to +10,000 or 0 to +10,000.

The first scaling screen shows the engineering units (AQ) value that corresponds the low span (output) value. Valid engineering units are -32768 to 32767.

```
S:1 CH1 ENG L
-10000
< > chg entr
```

1. If you want to change the displayed selection, press F3 (chg).
2. Enter the new value using the numeric keypad.
3. Press F4 (entr) to enter the new value or F3 (clr) to abort the change.

The high engineering units value for the channel is displayed next.

```
S:1 CH1 ENG H
10000
< > chg entr
```

If the low and high engineering units values are equal, the output of the channel is:

- the minimum output level (0 mV) if the AQ data is less than the low engineering units value,
- the maximum output level (approximately 10.5 V) span value if the AQ data is greater than or equal to the low engineering units value,
- The low span value is displayed next. This is the actual voltage in microvolts that a channel will output when the low engineering units value is commanded. Span values are changed in the same way that engineering units values are changed. Valid span values are -10,000 to +10,000 or 0 to +10,000. In the 0 to 10 V range, a negative value for low span can not be configured.

```
S:1 CH1 SPAN L
-10000
< > chg entr
```

The high span value for the channel is displayed next.

```
S:1 CH1 SPAN H
10000
< > chg entr
```

If the low and high span values are configured to be equal, the channel will output the same voltage for all engineering units (AQ) values. The output voltage will correspond to that low/high span value. For example, if both the low span and high span values were configured as 10,000, the output voltage for the channel would be 10V regardless of the AQ value.

The high span value must be greater than or equal to the low span value. If you enter a high or low span value that violates this condition, you will not be able to leave the span configuration screens until valid low and high values are configured. Pressing the CLEAR key in this situation will cause the HHM to display the following message:

```
Cfg Incomplete
Clear Slot ?
      yes  no
```

If you want to return to the span configuration screens, press F4 (no). If you want to clear the entire slot configuration instead, press F3 (yes). The slot will then be displayed as empty.

19. CONFIGURE AN 8-POINT ANALOG CURRENT OUTPUT MODULE

When you select “Read” from the empty slot HHR screen, this module screen appears:

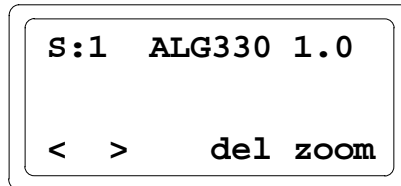
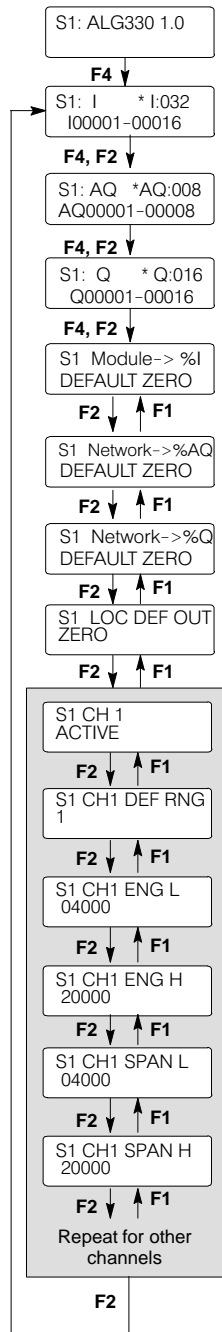

19.1. Assign I/O References for the Module

When you “zoom” into the module’s slot, a screen like this appears:

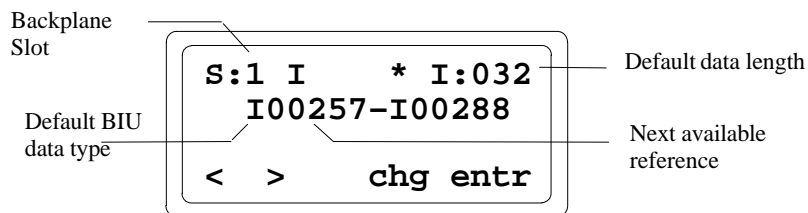

This I/O reference assignment screen shows the length and the next available reference address for each data type in BIU memory.

The 8-Point Analog Current Output Module is an intelligent module that uses more than one type of data.:

- up to 8 words of analog output data (data type AQ on the Hand-Held Monitor),
- 0–4 bytes of discrete input data (data type I) for module and channel status. Use of this data is optional,
- 0–2 bytes of discrete output data (data type Q) for clearing alarms. Use of this data is optional.

The length is displayed in units that are appropriate for the data type (analog output data is in words, discrete inputs and outputs are in bits). The asterisk indicates that the reference has not yet been defined.

The first screen shows references for discrete input (I) diagnostic data. You can display the other BIU data types by pressing F3 (toggle). Press F4 (enter) when the desired data type is displayed.

If the starting reference and length for the data type are acceptable, press F4 (enter) to accept them. The asterisk will disappear.

If you prefer to change the BIU table mapping, length or reference value, press F3 (change). Then press F3 to select a data table (data type).

```

S:1 I      I
Select table

      tgl entr
  
```

To configure the selected data type, press F4 (entr). You can edit the length on this screen.

```

S:1 I      I:032
Select length

      clr entr
  
```

Enter the new length from the keypad. Valid values are:

0, 8, 16, 24 or 32 (bits)	for discrete input (data type I) data.
0, 8 or 16 bits	for discrete output (data type Q) data.
up to 8 words	for analog output (data type AQ) data

If you enter a length of zero, the HHM displays **Unassigned** for that data type.

If you enter an invalid length, the HHM prompts: **BAD LENGTH ERR**. Data must be contained within byte boundaries; entries for length and reference address are automatically adjusted if needed. Lengths and reference addresses are adjusted down. For example, a length of 18 would be *adjusted* to 16 and a starting address of 5 would be *adjusted* to 1.

After entering a valid length, the offset (starting reference address) screen appears. The BIU automatically supplies the next available address for the selected data type. You can press F4 (enter) to accept the default value or enter a new value from the keypad. Press the F4 (enter) key after entering a new offset.

```

S:1 I      I:032
Ref Addr 00481

< >      clr entr
  
```

Module reference addresses for each data type must be greater than or equal to the starting addresses listed in the BIU map. If you enter an invalid address, the HHM prompts: **BAD REF ADDRESS**.

Use the F2 (>) key to display the screen for the module's analog output data.

```

S:1 AQ      *AQ:008
AQ00025-00032

< >      chg entr
  
```

You can edit this screen or accept it using the F4 (enter) key. The asterisk beside the data type disappears, to show that the current values have been saved. Valid values for analog output data length are 0–8. If this length is set to less than 8 and the module has not been previously configured the outputs of unused channels will go to 0 mA. However, if the module has been configured previously and is reconfigured to use fewer channels, the channels that are “removed” will continue to output current at their previously-configured levels until the module is reset.

```
S:1 AQ    AQ:008
AQ00025-00032
< >    chg entr
```

Pressing F2 (>) moves you to the screen that shows the module’s discrete output bits, which can be used by the host for clearing faults. Valid lengths for this data type are 0–16. The data must lie on byte boundaries; entered lengths and reference addresses are automatically adjusted if necessary.

```
S:1 Q    * Q:016
Q01817-01832
< >    chg entr
```

Edit the reference address and length if needed. Press F4 (enter) to save the selections.

Entries must be made for data types I, Q and AQ. If you do not want to use one of these data types, give it a length of zero.

If you back out (using F1 (<) or MENU) before all data types have been configured, the HHM displays the following screen:

```
Cfg Incomplete
Clear Slot?
        yes    no
```

If you exit, the I/O configuration choices are not saved.

The BIU will not send data to the module until all three data types (I, Q and AQ) have been configured.

19.1.1. Configure Data Defaults

Data default screens are displayed next. For the module’s diagnostic input bits (data type I), you can determine what the BIU should do with the data if the BIU loses communications with the module. Data can either be held at its present values or defaulted to zero.

```
S:1 Module-> %I
DEFAULT:ZERO
< >    tgl entr
```

You can accept DEFAULT: ZERO with the F4 (enter) key or press F3 (toggle) then F4 (enter) to change the default and save it.

```
S:1 Module-> %I
DEFAULT:HOLD
< > tgl entr
```

For the module's fault clearing discrete output bits (AQ and Q) you can determine what data the BIU will send to the module if the BIU loses communications with the network. Selectable values are ZERO and HOLD.

```
S:1 Network-> %Q
DEFAULT:ZERO
< > tgl entr
```

```
S:1 Network->%AQ
DEFAULT:ZERO
< > tgl entr
```

In an I/O station that includes local I/O control, some or all of the module's outputs may be assigned to addresses that are not within the BIU's I/O map. The defaults configured here do NOT apply to module outputs that are outside the BIU's I/O map.

19.1.2. Configure Local Default Outputs

Next, select the default output mode used for all channels in the event of a local (module) failure or reset.

This is not the same as the data defaults described on the previous page, which are for the BIU.

The choices for local default output are:

- A. ZERO: The output of each channel goes to 0 mA in the event of a local failure or reset.
- B. HOLD LAST: The output of each channel is held at the last value latched by the D/A converters in the event of a local failure or reset (provided the appropriate user power supply is present).

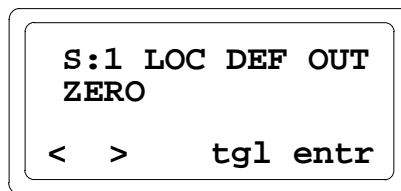

1. If you want to change the displayed selection, press F3 (Tgl).
2. Use the F4 (entr) key to save the selection.
3. Press F2 (>) to go to the next screen.

19.2. Circuit Configuration

The sequence in which circuit configuration screens appears depends on the revision level of the Hand-Held Monitor and the BIU.

19.2.1. Channel Header

If the BIU and Hand-Held Monitor support display of channel headers, a header screen appears for each channel as shown below.

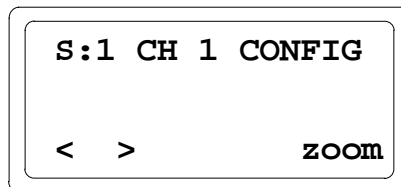

- A. Press F2 (>) from this screen to go to the header screen for the next channel. Pressing F2 (>) from channel 8 displays the module's first reference parameter screen.
- B. Press F1 (<) from this screen to go to the header screen for the previous channel. Pressing F1 (<) from channel 1 displays the module's last reference parameter screen.
- C. Press F4 (zoom) to go to the first configuration screen for the channel.
- D. When in a channel-specific configuration screen, press the up arrow/MENU key to go to that channel's header screen.

If the BIU and Hand-Held Monitor do not support display of channel headers, the header screens do not appear and keys F1 (<) and F2 (>) are used to scroll through channel-specific configuration screens.

The following features are configured for each channel.

19.2.2. Channel Active

When a channel is configured as Active, its analog output data is processed and its alarm conditions are returned. When a channel is configured as Inactive, its output goes to 0mA and its alarm conditions are not returned although any alarms that were already set can still be cleared using discrete output (Q) data.

```
S:1 CH 1
ACTIVE
< >    tgl entr
```

1. If you want to change the displayed selection, press F3 (Tgl).
2. Use the F4 (entr) key to save the selection.
3. Press F2 (>) to go to the next screen.

19.2.3. Scaling Range

Scaling can be used to define a constant-slope mapping from the value in engineering units sent by the BIU to a channel's output current. The default scaling configuration (selection 1 on this screen) provides an output current range of 4 mA (low span value) to 20 mA (high span value) for engineering units (AI) values of 4000 to 20000.

On this screen, specify the default range used for scaling analog output data. There are three predetermined range and data scaling combinations (selections 1, 2 and 3).

```
S:1 CH1 DEF RNG
1
< >    tgl entr
```

The default is 1. Selections 1 or 2 have low span (output current) values which are greater than 3.5 mA and therefore enable an "Open Wire" diagnostic bit which is set whenever the output falls below approximately 2 mA. "NONE" is used for display purposes only and cannot be selected if range 1, 2 or 3 is being used (see next paragraph). If you want to enter different scaling parameters than those used for selections 1, 2 or 3, change the span and engineering units values from the scaling screens.

Selection	Data Range = Output current (mA)
1	4000 to 20000 = 4000 to 20000
2	0 to 32000 = 4000 to 20000
3	0 to 32000 = 0 to 20000
none	User-configured scaling

The illustration below shows scaling for the default range selections.

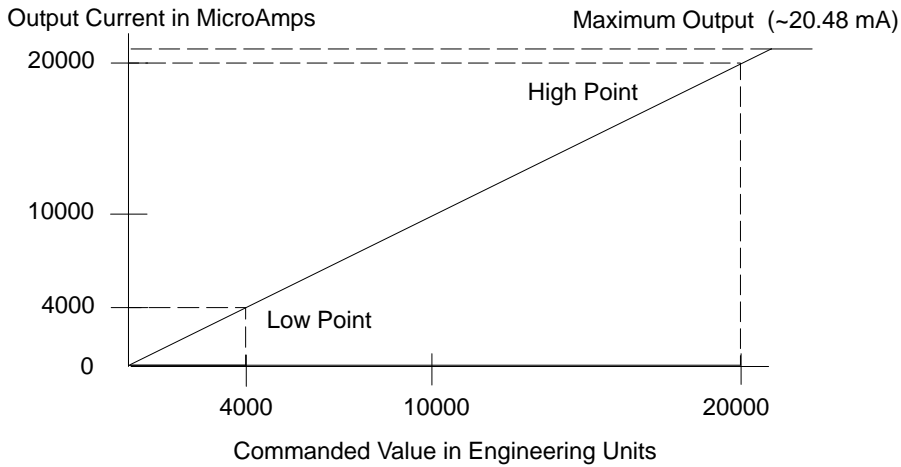

19.2.4. Output Scaling

If engineering and span values for a channel are entered during configuration rather than being set by a default range, “NONE” is displayed on the Default Range screen. “NONE” can then be selected again but will have no effect on the module configuration. The module performs its own scaling (unlike conventional Alspa CE80–20 analog modules, whose scaling is performed by the BIU).

19.3. Custom Scaling

To scale a channel, choose a high and low point and enter the actual input value (span) and a corresponding engineering units value for each point. During operation, the module will use these values to convert engineering units into digital values that represent output current. Engineering units values are 16-bit signed integers from –32768 to 32767. Span values are unsigned integers ranging from 0 to 20000.

The engineering and span points you select do not limit the actual hardware output range. For example, a channel whose range is configured to 1 will output current below 4mA for engineering units values below 4000 even though the low span value is 4mA. It is possible to choose scaling parameters that will cause the current output to be limited by the scaling process. For example, using a low engineering units value of –32768 (minimum value) and a high engineering units value of 32767 (maximum value) would effectively limit the output current to values between the corresponding low and high span values.

The first scaling screen shows the engineering units (AQ) value that corresponds to the low span (output) value. Valid engineering units are –32768 to 32767.

```
S:1 CH1 ENG L
04000
< > chg entr
```

1. If you want to change the displayed selection, press F3 (chg).
2. Enter the new value using the numeric keypad.
3. Press F4 (entr) to enter the new value or F3 (clr) to abort the change.

The high engineering units value for the channel is displayed next.

```
S:1 CH1 ENG H
20000
< > chg entr
```

If the low and high engineering units values are equal, the output of the channel is:

- the minimum output level (0 mA) if the AQ data is less than the low engineering units value.
- the maximum output level (approximately 20 mA) span value if the AQ data is greater than or equal to the low engineering units value.

The low span value is displayed next. This is the actual current in microAmps that a channel will output when the low engineering units value is commanded. Span values are changed in the same way that engineering units values are changed. Valid span values are 0 to 20000.

```
S:1 CH1 SPAN L
04000
< > chg entr
```

The high span value for the channel is displayed next.

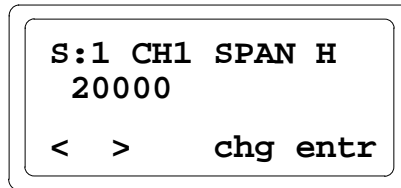

If the low and high span values are configured to be equal, the channel will output the same current for all engineering units (AQ) values. The output current will correspond to that low/high span value. For example, if both the low span and high span values were configured as 10000, the output current for the channel would be 10 mA regardless of the AQ value.

The high span value must be greater than or equal to the low span value. If you enter a high or low span value that violates this condition, you will not be able to leave the span configuration screens until valid low and high values are configured. Pressing the MENU Up key in this situation will cause the HHM to display the following message:

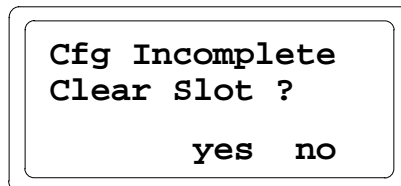

If you want to return to the span configuration screens, press F4 (no). If you want to clear the entire slot configuration instead, press F3 (yes). The slot will then be displayed as empty.

20. CONFIGURE A MICRO FIELD PROCESSOR

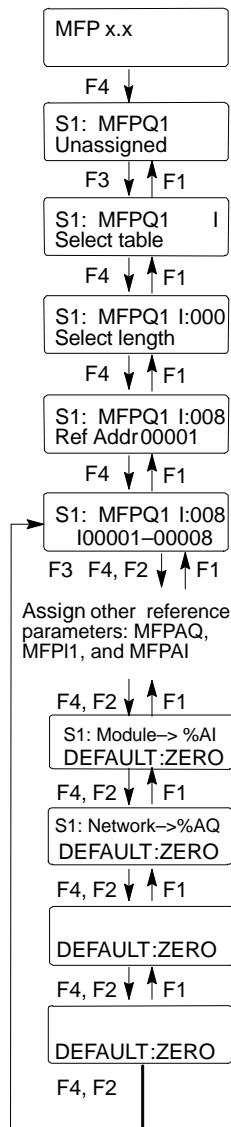

There are two basic steps to configuring a Micro Field Processor (MFP):

1. **Configuring the MFP's Reference Parameters**, as described here. Reference Parameter is the term used here to describe data (usually of more than one data type) that is transferred between an intelligent module and the Bus Interface Unit *during each BIU sweep*. All data exchanged by intelligent modules in an Alspa CE80-20 station is called Reference Parameters.
2. **Configuring any Group Data Moves** that will be used to transfer Micro Field Processor data *during specified BIU sweeps*. All Group Data Moves are considered part of the Bus Interface Unit's own configuration. Instructions for configuring Group Data Moves begin on Subsection 20.4.

It is possible to configure a Micro Field Processor (or any other type of intelligent module) to have only Reference Parameters and no Group Data or only Group Data and no Reference Parameters. But both types of data transfers can be used in a system. The typical configuration is to use only Reference Parameters.

20.1. Configure the Reference Parameters for the Micro Field Processor

To configure Reference Parameters for a Micro Field Processor, go to this menu:

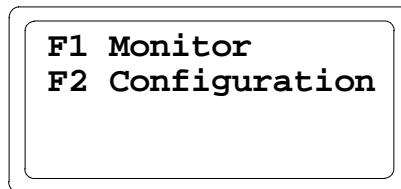

Select F2 (configuration). If the module has not previously been added to the BIU configuration, the module configuration screen looks like this:

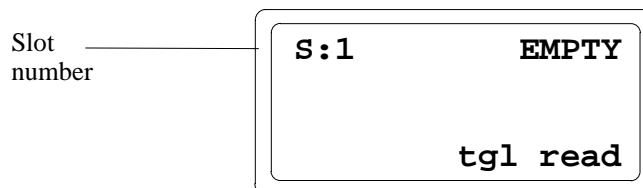

If the module is already installed and powered up, select F2 (>) repeatedly until the menu below appears, then press the F4 (read) key.

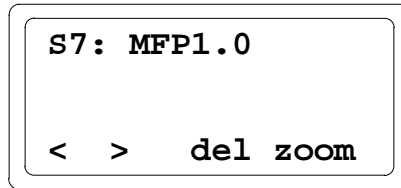

Press F4 (zoom). The HHM displays the first MFP data type screen.

20.2. Select Data Types for Micro Field Processor Data

To configure BIU references for MFP data, use the cursor (F1, F2) keys to go through the available MFP data types. On the example screen below, the displayed MFP data type is Q (discrete outputs). If a data type has not been configured or if it has been configured with a length of zero, the display indicates that it is not assigned:



Note that data from the BIU to the Micro Field Processor's discrete output (Q) table will always start at Q00001 within the Micro Field Processor, as shown on the HHM screen above (MFPQ1). Similarly, data from the Micro Field Processor discrete input (I) table to the BIU will always come from the MFP starting at I00001 (which is indicated on the HHM as MFP11).

If you do not want any reference parameters for a Micro Field Processor (if you are using Group Moves to transfer all data between the MFP and the BIU), you must still configure at least one reference parameter with a length of zero. The reference parameter configured with the zero length will show as unassigned.

To assign references to the presently-displayed data type, press the F3 (change) key. the screen displays:

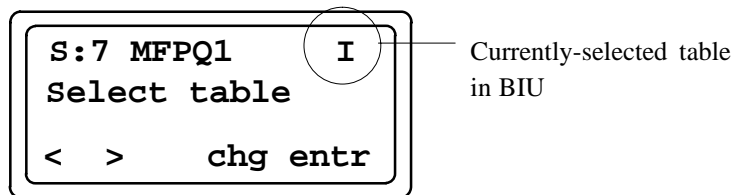

The upper right corner of the screen shows the BIU table type for the data. On the screen above, it is the discrete input (I) table. Normally, the same data type is used in both the MFP and the BIU. Use the F3 (change) key to choose the correct BIU table type.

The HHM then requests a length for that data type. This is the amount of data of the selected type that will be exchanged with the BIU.

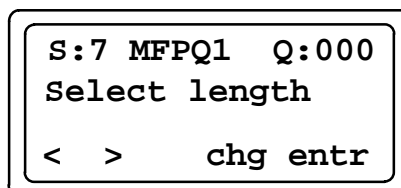

Enter the data length from the keypad, then press F4 (enter) to save it. The HHM displays the offset (reference address) of the first reference of the selected type that is available in the BIU. For example, if Q00001 to Q00032 were already assigned to other modules, the next available reference would be Q00033:

```
S:7 MFPQ1 Q:016
Ref Addr 00033
< > chg entr
```

If you enter an invalid length value or overlapping references, the HHM displays an error message. If that happens, press the HHM Clear key and make a new entry.

If you enter a number that is not on a byte boundary for discrete data, the BIU will round down to the nearest correct offset.

Select other MFP data types and specify BIU data types and references.

20.3. Assign Data Defaults

Next, set the default for each configured type of BIU data (unassigned data types are not displayed here).

For the input data types AI and I, select what the BIU should do with the MFP's data if the BIU loses communications with the MFP. Data can either be held at its present values or defaulted to zero.

```
S:4 Module-> %I
DEFAULT:ZERO
< > tgl entr
```

```
S:4 Module-> %AI
DEFAULT:ZERO
< > tgl entr
```

You can accept DEFAULT: ZERO with the F4 (enter) key or press F3 (toggle) then F4 (enter) to change to DEFAULT: HOLD and save it.

For output (Q and AQ) data which is included within the BIU's I/O map, determine what data the BIU will send to the module if the BIU loses communications with the network.

```
S:4 Network-> %Q
DEFAULT:ZERO
< > tgl entr
```

```
S:4 Network->%AQ
DEFAULT:ZERO
< > tgl entr
```

When you are finished assigning and saving the Reference Parameters and data defaults for the Micro Field Processor, use the F2 (>) to return to the first Micro Field Processor configuration screen.

20.4. Configure Group Data Moves

The BIU, Micro Field Processor and intelligent modules can also be configured for “Group” data transfer. Group data is a set of data that the BIU regularly transfers from one location in the station to another.

Up to 16 data groups can be set up for an I/O station. Each group can consist of up to four separate data moves *between the same two devices and in the same direction*. For more information about Group data, see chapter 4 Subsection 1.3.

You might use a form like the one below to record your Group Data assignments. There is also a worksheet for I/O module reference assignments on Section 6.

Group Data Moves Worksheet

Data Group	Source Slot	Dest. Slot	BIU Scans	Move No	Src. Ref.	Dest. Ref.	Data Len.	Data Group	Source Slot	Dest. Slot	BIU Scans	Move No	Src. Ref.	Dest. Ref.	Data Len.
1			1 2 3 4	1				9			1 2 3 4	1			
			5 6 7 8	2							5 6 7 8	2			
			9 10 11 12	3							9 10 11 12	3			
			13 14 15 16	4							13 14 15 16	4			
2			1 2 3 4	1				10			1 2 3 4	1			
			5 6 7 8	2							5 6 7 8	2			
			9 10 11 12	3							9 10 11 12	3			
			13 14 15 16	4							13 14 15 16	4			
3			1 2 3 4	1				11			1 2 3 4	1			
			5 6 7 8	2							5 6 7 8	2			
			9 10 11 12	3							9 10 11 12	3			
			13 14 15 16	4							13 14 15 16	4			
4			1 2 3 4	1				12			1 2 3 4	1			
			5 6 7 8	2							5 6 7 8	2			
			9 10 11 12	3							9 10 11 12	3			
			13 14 15 16	4							13 14 15 16	4			
5			1 2 3 4	1				13			1 2 3 4	1			
			5 6 7 8	2							5 6 7 8	2			
			9 10 11 12	3							9 10 11 12	3			
			13 14 15 16	4							13 14 15 16	4			
6			1 2 3 4	1				14			1 2 3 4	1			
			5 6 7 8	2							5 6 7 8	2			
			9 10 11 12	3							9 10 11 12	3			
			13 14 15 16	4							13 14 15 16	4			
7			1 2 3 4	1				15			1 2 3 4	1			
			5 6 7 8	2							5 6 7 8	2			
			9 10 11 12	3							9 10 11 12	3			
			13 14 15 16	4							13 14 15 16	4			
8			1 2 3 4	1				16			1 2 3 4	1			
			5 6 7 8	2							5 6 7 8	2			
			9 10 11 12	3							9 10 11 12	3			
			13 14 15 16	4							13 14 15 16	4			

20.4.1. Set Up a Group Data Move

To configure one or more Data Groups, begin at the Main Menu for the BIU:



From this menu, press F2 (Configuration). This menu appears:

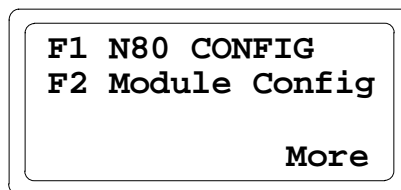

Press F3 to display the next configuration screen:

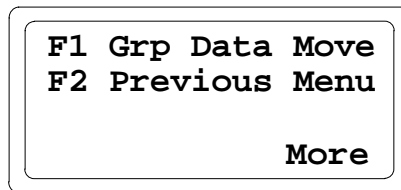

Press F1 to display the first Group Data Move configuration screen:

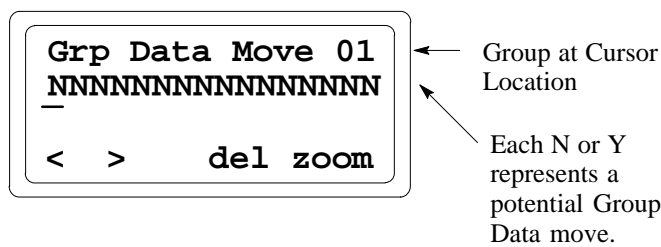

On this screen, each of the 16 potential Data Groups is represented by a letter N (no moves are defined for that group) or Y (for Yes, at least one move is defined in the group). The number of the Data Group indicated by the cursor also appears in the upper right corner of the screen.

Move the cursor under the number of a group to set up and press F4 (zoom).

20.4.2. Identify the Source and Destination Device

The HHM is now ready to configure the parameters for the Group.

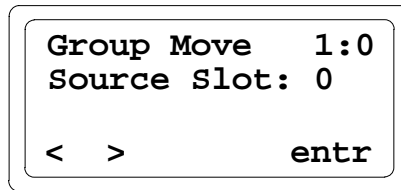

The number in the upper right corner of the HHM screen shows the group number (1 in the example above). The 0 indicates the slot definition.

For each group move, the BIU can move data in one direction, to or from any intelligent module in the I/O Station including itself. It is also possible to move data from one memory type in the BIU to another memory type in this manner.

Note the following about Group Moves:

1. If a Group Move involves an intelligent module, the module must be present to configure the Group Move.
2. If a Group Move has been configured with an intelligent module involved and the intelligent module is then deleted from the configuration, the Group Move containing that module is automatically deleted.
3. The individual moves within a Group Move are not done by the BIU in sequential order. For example, two Group Moves would be needed to make the following moves sequentially:

Slot 0 (the BIU)	to	Slot 0 (the BIU)
I00001	to	Q00001, length 2
Q00001	to	I00017, length 2

The BIU would not move the contents of I00001 – I00016 into Q00001 – Q00016, then move the same data out of Q00001 – Q00016 into I00017 – I00032.

Both the device being read from and the device being written to are identified by specifying their “slot” number (location in the I/O Station) as part of the group configuration.

On the screen shown above, enter the slot number of the module (0 for the BIU, 1 to 8 for any other module) that will be the source of the data.

Press the F4 (enter) key to accept the slot. Press F2 (>) to go to the next configuration screen.

Next, enter the slot number of the module (0 for the BIU, 1 to 8 for another module) that will receive the Group Data. For example:

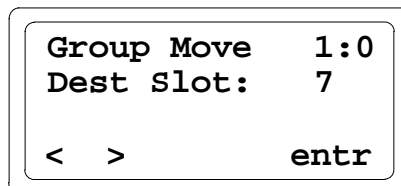

The Destination can be the same module specified as the Source.

Press the F4 (enter) key to accept the destination slot, then press F2 (>) to go to the next configuration screen.

20.4.3. Configure the First Move for a Group

```

Group Move    1:1
Src Ref:%AI00009

< >    tgl entr

```

For each data type, a starting offset and length can be specified. It is not necessary to move all of a module's data of a particular type. You can specify any suitable offset and length.

If the reference is to a BIU table, you must enter the actual address of the data. The BIU will calculate the offset.

For a Micro Field Processor, the following data types can be read or written: R, AI, AQ, A, I, Q, M, T, G. In addition, data of types S, SA, SB and SC can be moved from the MFP to BIU (only). The BIU has read access only to these tables.

Press the F4 (enter) key to accept the Source Reference. Press F2 (>) to go to the next configuration screen.

Next, enter the Destination Reference:

```

Group Move    1:1
Des Ref: %R00002

< >    tgl entr

```

Press the F4 (enter) key to accept the Destination Reference. Press F2 (>) to go to the next configuration screen.

Enter the length for the data to be moved.

```

Group Move    1:1
Byte Len: 032

< >    entr

```

20.4.4. Configure More Moves for a Group

Continue from the screen shown above to configure additional moves in the same group.

It is not necessary to configure moves that are not used—a group can have 1, 2, 3 or 4 moves.

20.4.5. Configure the Defaults for Each Move in a Group

Next, establish the defaults for each move in a Group. This determines how the BIU responds if it loses communications with the module that is the source of the data. The BIU continues performing the Group Data moves even if it is not able to read fresh data from the Source module. If the source is slot 0 (the BIU itself) and the data type is discrete or analog output (Q or AQ) and that data is included within the BIU's I/O map of data received from the network, these determine what happens if network communications are lost.

On the next screen, specify whether the BIU should set the data it transfers to all zeros or hold the data in its last valid states.

Make this selection for each move in the Group by moving the cursor under the selection for each move (move 1 of Group 1 in the example below). Use the F3 (toggle) key to select either Y for Default to Zero or N for Hold Last State.

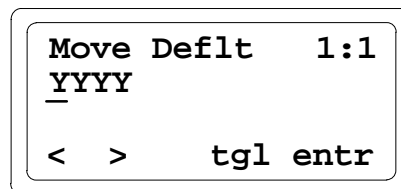

Press the F4 (enter) key then press F2 (>) to go to the next configuration screen.

20.4.6. Specify the BIU Scanning Frequency for the Data Group

An important characteristic of Group Data is that it does not need to be moved during each BIU sweep. The last step in configuring a Group is to specify the sweeps during which the data should be moved. If you need more information, see chapter 4 Subsection 1.3.

The screen shows the scans (1 to 16) when the BIU will transfer the indicated Data Group. The number of the current Data Group appears in the upper left corner of the screen.

If every location on this screen is set to Y (yes), the BIU will transfer the data during each of its sweeps. If every location is set to N, the BIU will never move the Group Data. Setting only one location to Y and the rest to N means the data will be transferred during every 16th sweep by the BIU.

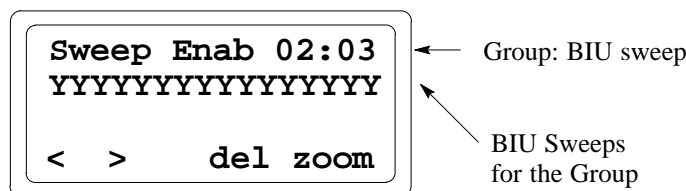

Use the F3 (toggle) key to change to "N" any sweep the Group should not be moved. You can select any combination of sweeps. Select a number that is appropriate for the data in the Group. Remember that skipping sweeps will speed up the operation of the BIU.

After completing this screen, press F4 (enter) to download the group definitions to the module and update the group in the BIU EEPROM.

20.4.7. Return to the Group Screen

After configuring a Group, use the HHM's Clear key or F1 (<) to return to the Group screen.

20.4.8. Deleting a Group Data Move

To remove one or more Data Groups, begin at the Main Menu for the BIU:

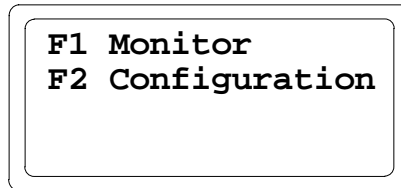

From this menu, press F2 (Configuration). This menu appears:

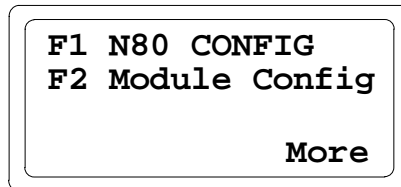

Press F3 to display the next configuration screen:

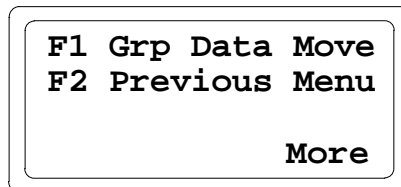

Press F1 to display the first Group Data Move configuration screen:

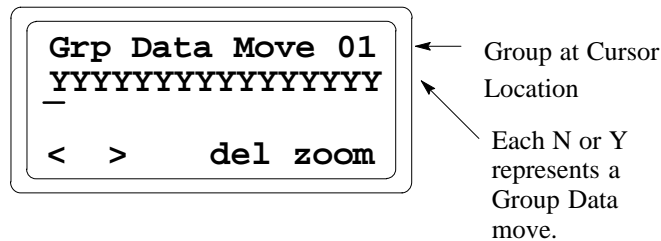

On this screen, each of the 16 potential Data Groups is represented by a letter N (for No) or Y (for Yes). The number of the Data Group indicated by the cursor also appears in the upper right corner of the screen.

To delete a previously-configured data group, on the screen shown directly above, move the cursor under the group to delete. Press F3 (delete) to remove the configuration for that group.

Chapter 6

Diagnostics and Fault Clearing

This chapter describes the diagnostics capabilities of the Bus Interface Unit and explains how faults can be cleared from a Hand-Held Monitor or programmer.

- Diagnostics and Fault Clearing for Intelligent Modules.
- Diagnostics and Fault Clearing for the BIU and Conventional Modules.
- Display and Clear Faults from an Hand-Held Monitor.
- Display and Clear Faults from an Alspa 8000 PLC.

1. DIAGNOSTICS AND FAULT CLEARING FOR INTELLIGENT MODULES

Some types of Alspa CE80–20 modules, for example, RTD and Thermocouple modules, can provide module and circuit diagnostics in the form of discrete input data. This data can be automatically sent to the host and used by the host as needed. The content of each type of intelligent module's diagnostic data is different. Details are given in the module's datasheet.

This diagnostic information is separate from the fault table and fault clearing procedures used by the BIU and conventional I/O modules. The faults do not count in the total number of faults that can be stored by the BIU.

The host can clear an intelligent module's diagnostic bits using the module's discrete output bits. These faults cannot be cleared using a Hand-Held Monitor or by sending a Clear Faults datagram.

2. DIAGNOSTICS AND FAULT CLEARING FOR THE BIU AND CONVENTIONAL MODULES

The Bus Interface Unit reads faults from conventional modules in the I/O station. These faults can be viewed and cleared from a programmer fault table or from a Hand-Held Monitor. The following table lists the fault messages generated by the N80 Bus Interface Unit for module and circuit faults on conventional I/O modules.

BIU Level Faults	Corrupted EEPROM
Module Level Faults	Unsupported Feature Calibration Memory Failure System Configuration Mismatch Fuse Blown Loss of I/O Module Addition of I/O Module Extra I/O Module Loss of User Power
Circuit Level Faults	Analog Open Wire Analog High Alarm Analog Low Alarm Analog Over Range Analog Under Range

In addition, the Bus Interface Unit itself provides the following diagnostics:

- Serial Bus Address conflict,
- Loss of communications,
- Loss of controllers,
- EPROM fault,
- RAM fault,
- Processor fault.

Maximum Number of Uncleared Faults

The Bus Interface Unit can store up to 32 uncleared faults at one time in its internal fault table. The same internal table is used for faults from I/O modules and Bus Interface Unit faults.

As faults occur, the first 16 are saved in the internal table. They stay there until the faults are cleared; none of these 16 faults will be lost if the table overflows. However, for faults 17 through 32, the internal fault table operates as a First-In-First-Out stack. When fault 33 occurs, fault 17 is dropped from the table.

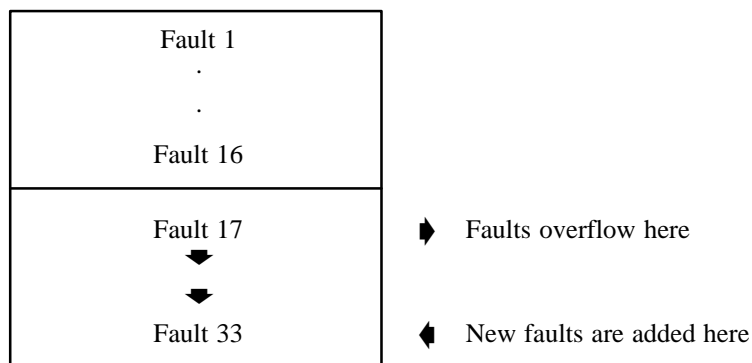

3. DISPLAY AND CLEAR FAULTS FROM A HAND-HELD MONITOR

3.1. Displaying Faults

A Hand-Held Monitor can display faults from a Bus Interface Unit while attached anywhere on the N80 network.

- From the HHM Main Menu shown below, display the HHM's special set of menus for the Bus Interface Unit.

```

F1:HHM UTILITIES
F2:ANALYZE
F3:CONFIGURATION
F4:DEVICE MEMORY

```

- If the Bus Interface Unit is the currently-selected device, press either F3 (Configuration) or F2 (analyze) twice.
- If the Bus Interface Unit is NOT the currently-selected device:
 - Select F2 (analyze) then F3 (Block/Bus Status).
 - Press the F1 (nxt) or F2 (prev) key repeatedly until you reach the serial bus address of the Bus Interface Unit. Press F3 to make the Bus Interface Unit the active device. Then, press the keypad Menu key, followed by F2 (Monitor/Control Reference).

The HHM's Main Menu for the Bus Interface Unit appears:

```

F1 Monitor
F2 Configuration

```

- Select F1 (monitor) to display this menu:

```

F1 Monitor I/O
F2:Faults

F3 Previous Menu

```

- Select F2 (faults) to display fault information for the Bus Interface Unit and its modules.
- The Faults menu appears:

```

F1 First 16 Flts
F2 Last 16 Flts

F3 Previous Menu

```

5. Press F1 to display the first set of 16 faults (one fault at a time). For example:

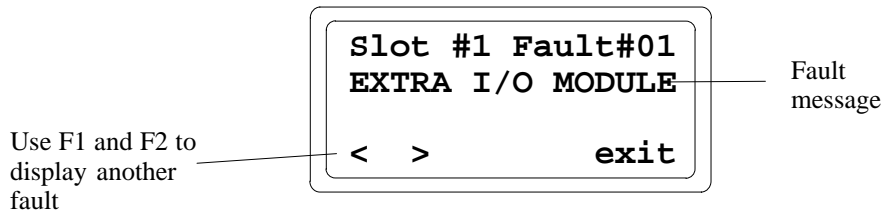

If there are no faults, the HHM displays the message: **No Faults** on the top line.

6. To display the last 16 faults (if any):
 1. Press F4 (exit) to return to the screen shown at the top if this page.
 2. Press F2 (last 16 faults).

3.2. Clearing Faults

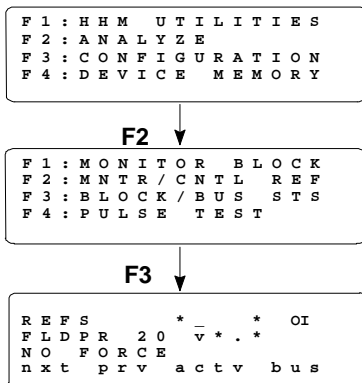

If faults are present, pressing Clear here has no effect. To clear faults from the Hand-Held Monitor you need to do the following:

1. Return to the HHM Main Menu.
2. Press F2 (Analyze).
3. Press F3 (Block/Bus Status).
4. Press the Clear key.

Clearing faults from the Hand-Held Monitor does not clear faults at the host PLC. To keep the entire system in step and up-to-date, fault clearing should be performed from the host PLC.

4. DISPLAY AND CLEAR FAULTS FROM AN Alspa 8000 PLC

A PLC places faults from an Alspa CE80–20 station are placed in the I/O and PLC Fault Tables.

4.1. Alspa C80–75 PLC I/O Fault Table

The content of the I/O fault display depends on the revision level of the PLC's Bus Controller module and the type of programmer software being used.

With a Bus Controller that is version 4.6 or later, when a fault occurs on an Alspa CE80–20 station, the I/O Fault Table shows the station ID and the rack and slot within the station where the fault has occurred:

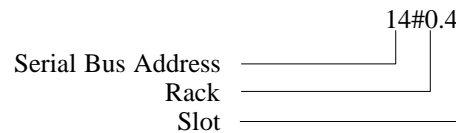

If the Bus Controller is only a rev. 3 version, it cannot transfer to the PLC the detailed fault information provided by a Bus Interface Unit. Instead, a rev. 3 Bus Controller reports any fault from a remote station as a **GENA** fault.

To clear the fault table, press the Clear key.

You must clear the I/O Fault Table from the programming software for the fault to be cleared in the PLC CPU and for the associated fault contact to be cleared. *Clearing faults with a Hand-Held Monitor alone does not remove them from the Fault Table, or cause any associated –[FAULT]– contacts to stop passing power flow.*

Clearing the I/O Fault Table at the PLC causes the Bus Controller to send a Clear All Circuit Faults background message to all blocks on the bus. Faults can be cleared from the Fault Table either from the fault table display or by the application program.

Clearing the fault table removes the faults it contains; it does not clear fault conditions in the system. If the condition that caused a fault still exists and is detected, the fault will be reported again.

Note: If faults are cleared from the PLC before the BIU has received outputs from the PLC, some faults such as Loss of Module or Extra Module are lost.

4.2. Alspa C80–75 PLC Fault Table

The PLC Fault Table shows the station ID and the location within the station where the fault has occurred:

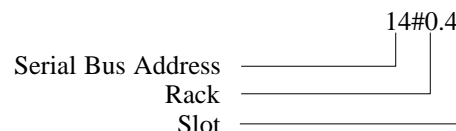

Pressing the Clear key from this display clears the entire PLC Fault Table. If there are *no* faults in the I/O Fault Table, then pressing Clear will also clear Bus Interface Unit faults.

Chapter 7

Monitoring and Controlling Alspa CE80–20 Data

This chapter explains how to monitor or control Alspa CE80–20 I/O data using a Hand–Held Monitor or a programmer.

- Overview,
 - Forcing Circuits,
 - Overriding I/O Circuits,
- Monitor/Control I/O Data: Hand–Held Monitor,
 - Changing the Reference Type Being Displayed,
 - Displaying Another Reference,
 - Changing the Display Mode,
 - Forcing/Unforcing the Displayed Reference,
- Monitor/Control I/O Data: Alspa 8000 PLC,
 - Reference Tables Display from the PLC,
- Monitor/Control I/O Data: Computer.

If you are using another type of programmer software, please consult the documentation supplied with that software for instructions.

1. OVERVIEW

There are two ways to manipulate I/O data in a station:

- A. by forcing an input or output to assume a desired state or value which will be stored in the BIU's EEPROM memory. This is done with a Hand–Held Monitor; no equipment other than the I/O module(s) is required. It can also be done using datagrams. Forces can only be applied to the portions of the BIU's internal memory that are included in the BIU's I/O map. Forces cannot be applied to references that lie outside the I/O map. Forcing guarantees consistent I/O behavior regardless of power failures or communications interruptions. If you want to check out a circuit at the station, the simplest way is with a Hand–Held Monitor, using force/unforce.
- B. for a host PLC, data can be manipulated by overriding an input or output state in the PLC's override tables. This is done with the programmer. The PLC and N80 Bus Controller must be connected to the Bus Interface Unit and must be operating.

Both methods are described on the following pages. They are valuable tools for verifying circuit wiring in an Alspa CE80–20 station.

1.1. Forcing Circuits

Forcing an I/O circuit from a Hand–Held Monitor causes the circuit to assume a selected state (for discrete circuits) or value (for analog circuits). Once forced, a circuit retains the selected state or value even if power is cycled. The forced circuit ignores data from an attached input device or output data from a CPU. Forcing is the only method of manipulating I/O circuits that guarantees a fixed output/input state.

While any circuit in the station is forced, the Bus Interface Unit's I/O Enabled LED blinks.

The force is normally applied and removed with the Hand–Held Monitor. When unforced, a circuit responds to real input or output data. Output circuits begin accepting CPU outputs. If no CPU outputs are available, the output will either go to its programmed default state or hold its last state, according to the circuit's preselected configuration.

The only other action that removes forces is a configuration change to delete a module. In that case, all forced data is assumed obsolete and is discarded.

Note

Forcing supercedes all other considerations, including default and hold last state.

If a discrete circuit configured to hold its last state is forced while the Bus Interface Unit online, the forced state is considered to be the last state.

If the Bus Interface Unit goes offline and the force is removed while offline, the circuit remains in the forced state, rather than assuming its actual last state. When the Bus Interface Unit goes back online, the circuit will again accept outputs normally.

1.2. Overriding I/O Circuits

Overriding an I/O circuit means changing its state or value in the PLC's Override Tables. Overrides must be done from the PLC, with the Bus Interface Unit online. Results can be viewed on the programmer screen.

The override data is stored in the PLC and survives loss of power in the PLC. However, if power is lost at the PLC but not at the Bus Interface Unit, the Bus Interface Unit operates as it normally does if CPU communications are lost. Outputs go to their default state or hold their last state (as configured). Once power is restored at the PLC and CPU communications resume, the output overrides again take effect.

2. MONITOR/CONTROL I/O DATA: HAND–HELD MONITOR

A Hand–Held Monitor can be used to display diagnostics (see chapter 8) and current I/O states and to force and unforce individual I/O points.

1. From the HHM Main Menu shown below, display the HHM’s special set of menus for the Bus Interface Unit.

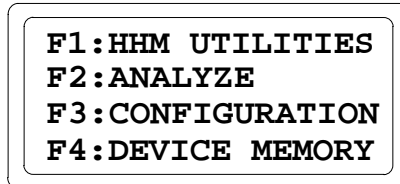

- A. If the Bus Interface Unit is the currently-selected device, press either F3 (Configuration) or F2 (analyze) twice.
- B. If the Bus Interface Unit is NOT the currently-selected device:
 - Select F2 (analyze) then F3 (Block/Bus Status).
 - Press the F1 (nxt) or F2 (prev) key repeatedly until you reach the serial bus address of the Bus Interface Unit. Press F3 to make the Bus Interface Unit the active device. Then, press the keypad Menu key, followed by F2 (Monitor/Control Reference).

The HHM’s Main Menu for the Bus Interface Unit appears:

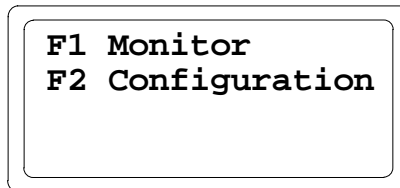

2. Select F1 (monitor) to display this menu:

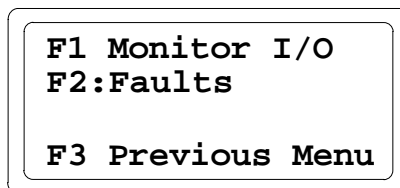

3. Select F1 (monitor I/O) to display I/O information for the Bus Interface Unit and its modules.

The first screen that appears is the Monitor screen for the first %I reference.

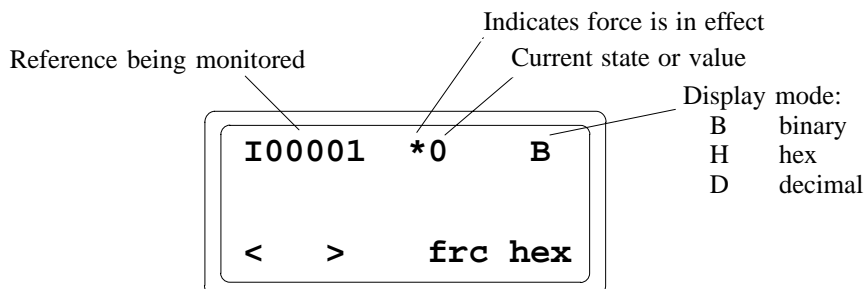

2.1. Changing the Reference Type Being Displayed

Use the F1 (<) key to select a reference type: I (discrete inputs), Q (discrete outputs), AQ (analog outputs) or AI (analog inputs).

2.2. Stepping Through the Configured References of the Displayed Type

Use the F2 (>) key to advance through the point reference screens for the selected reference type.

2.3. Displaying a Specific Reference

If you want to go directly to a specific reference:

1. Display the reference type I (discrete inputs), Q (discrete outputs), AQ (analog outputs) or AI (analog inputs) as described above.
2. Press the HHM's \pm key.
3. Enter the reference number from the keypad.
4. Press the F4 (enter) key.

2.4. Displaying References that are Outside the BIU's I/O Map

If you want to display a reference that lies outside the I/O map that has been configured for the Bus Interface Unit, follow the instructions for Displaying a Specific Reference.

2.5. Changing the Display Mode

Use the F4 (mode) key to change change the displayed point state or value to hex (H), binary (B) or decimal (D) format.

2.6. Returning to the Previous Menu

From this screen, press the HHM Clear key to return to the main Bus Interface Unit menu.

2.7. Forcing/Unforcing the Displayed Reference

Individual I/O points can be forced and unforced from the Hand–Held Monitor (the HHM’s circuit forcing capability must be enabled to use this function).

Forcing an I/O point changes its state in the Bus Interface Unit’s EEPROM memory. If the circuit is an output, the physical state of the output also changes. If the circuit is an input, the forced input data is sent to the CPU. Once forced, a circuit retains the forced state or value if power is removed. The forced circuit ignores data from an attached input device or output data from the CPU. The force can ONLY be removed from the Hand–Held Monitor.

1. Select the correct data type for forcing (Binary for discrete I/O or Decimal for analog I/O). Press F4. to change the data type.

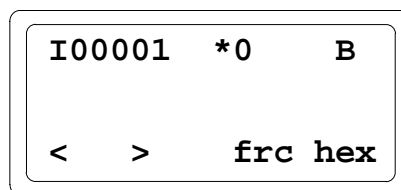

2. Press the F3 (force) key to force the reference now being displayed:

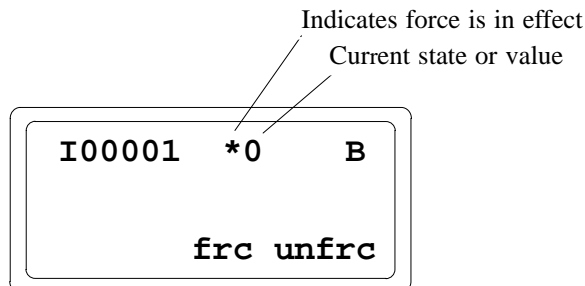
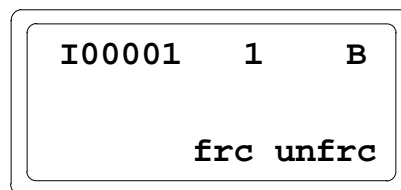

3. Press F3 (force) again. Then, use the HHM keypad to enter the force state or value.
4. Use the F4 (unforce) key from the same screen when you want to unforce the point.

3. MONITOR/CONTROL I/O DATA: ALSPA 8000 PLC

If the host is an Alspa 8000 PLC, I/O data can be displayed in the PLC's reference tables. The PLC's reference tables displays will include those portions of the PLC's I, Q, AI and AQ memory being used by a Bus Interface Unit.

In the reference tables for the PLC, these inputs are displayed along with other system inputs. When the programmer is attached to the PLC, the programmer software can override or toggle the I/O data and cause a change.

4. MONITOR/CONTROL I/O DATA: COMPUTER

To utilize the Bus Interface Unit's I/O data correctly, a computer must know the sequence of modules in the station and the amount of input and output data each has.

For the PCIM, QBIM and other GENI-based interfaces, the input and output data will occupy the Device Input and Output Tables at the segments associated with the serial bus address of the Bus Interface Unit.

I/O Tables

<p>Input Table 32 segments, 128 bytes each</p>
<p>Output Table 32 segments, 128 bytes each</p>

The Bus Interface Unit automatically sends all discrete inputs followed by all analog inputs from the station, each bus scan. The PCIM or QBIM places this data into its Input Segment. The application program must read the Input Segment to obtain the input data from the PCIM or QBIM.

Input Table Segment for a Bus Interface Unit

<p>Discrete Inputs Bits (number of bytes = configured I length / 8)</p>
<p>Analog Input Words (number of bytes = configured AI length X 2)</p>

The Output Segment is used similarly. The application program must send to the PCIM or QBIM's Output Segment all the discrete outputs followed by all the analog outputs for the station. The PCIM or QBIM will automatically direct the outputs to the Bus Interface Unit each bus scan.

Chapter 8

Datagrams

This chapter lists datagrams that can be sent to a Bus Interface Unit and shows the datagrams for Alspa CE80–20 modules that are different from the formats used by other modules.

It also shows the format of configuration data for the Bus Interface Unit and the modules in the station.

- Datagram Types,
- Read Map,
- Read Map Reply,
- Write Map,
- Report Fault Datagram Format,
- Configuration Data,
- Set Bus Interface Unit Operating Mode,
- Set Micro Field Processor Operating Mode,
- 16 Point Grouped Analog Module Recalibration Datagram.

For Additional Information, Also See:

The *Bus Controller User's Manual* for the PLC or computer, which explains the specific programming used to send datagrams.

The *ALS 52301 Alspa CE80–15 I/O System and Alspa N80 Communications Network User's Manual*, which describes N80 datagrams and data formats.

1. DATAGRAM TYPES

The table below shows the primary datagrams that may be acted upon by the Bus Interface Unit. The table lists the types of device that can send each datagram and the resulting action taken by the Bus Interface Unit.

Datagram Type	Subfunction Code	Sent From	Bus Interface Unit Action
Read Identification	00	BC, HHM	send Read ID Reply
Read Configuration	02	BC, HHM	send Read Configuration Reply
Write Configuration	04	BC, HHM	process (possibly send configuration changes)
Assign Monitor	05	BC	process
Begin Packet Sequence	06	BC, HHM	start sequence
End Packet Sequence	07	BC, HHM	end/check sequence
Pulse Test	10	HHM	send Pulse Test Complete
Clear All Faults	13	BC, HHM	process
Set Status Table Address	17	BC, HHM	process
Force BSM	1A	BC, HHM	process (send config. change)
Unforce BSM	1B	BC, HHM	process (send config. change when last point is unforced)
Switch BSM	1C	BC	process
Set MFP Operating Mode	21	BC	
Recalibrate Analog Module	21	BC	
Read Map	2A	BC, HHM	send Read Map Reply
Write Map	2C	BC, HHM	process—autoconfigure
Set Operating Mode	39	BC	process
Read I/O Forces	40	BC	send Read I/O Forces Reply
Read Slot Diagnostics	42	BC	send Read Slot Diagnostics Reply

Table 8.1 – Datagrams for the BIU

A PLC or computer can send a datagram to the Bus Interface Unit in the same manner as sending a datagram to an I/O block or Bus Controller.

2. READ MAP

Subfunction Code: 2A hex

This datagram is used to read the reference addresses and lengths that have been configured for the BIU's network I/O map.

Data Field Format: none

3. READ MAP REPLY

Subfunction Code: 2B hex

A Bus Interface Unit sends this reply datagram after receiving a Read Map datagram. It contains the previously-configured BIU network map addresses. The BIU's network map defines the BIU memory locations of the data that is exchanged on the bus. It provides no information about the I/O assignments of individual I/O modules in the station. However, the checksums indicate that the overall configuration remains unchanged.

Byte No.	Byte Description
0	Not used
1	Starting reference for discrete input (I) data (LSB)
2	Starting reference for discrete input (I) data (MSB)
3	Length of discrete input (I) data (in bytes)
4, 5	Starting reference of analog input (AI) data
6	Length of analog input (AI) data (in bytes)
7, 8	Starting reference of discrete output (Q) data
9	Length of discrete output (Q) data (in bytes)
10,11	Starting reference of analog output (AQ) data
12	Length of analog output (AQ) data (in bytes)
13	8-bit Additive Checksum Unused
14, 15	16-bit LRC Critical Checksum (lsb in 14, msb in 15) READ ONLY
16	Alspa CE80-20 8-bit Additive Checksum. Unused
17, 18	Alspa CE80-20 16-bit CRC Non-Critical Checksum (lsb in 17, msb in 18) READ ONLY

Starting references in I, AI, Q and AQ memory are returned. For each memory type, a data length is also supplied. If a length is zero, the associated starting reference can be ignored; it is not meaningful.

4. WRITE MAP

Subfunction Code: 2C hex

This datagram allows a CPU to change a previously-configured or unconfigured BIU network map addresses, if configuration is not currently protected. The BIU's network map defines the BIU memory locations of the data that is exchanged on the bus. Starting references in I, AI, Q and AQ memory are sent. If any length is zero, the associated starting reference is ignored; it is not meaningful.

Byte No.	Byte Description
0	Not used
1	Starting reference for discrete input (I) data (LSB)
2	Starting reference for discrete input (I) data (MSB)
3	Length of discrete input (I) data (in bytes)
4, 5	Starting reference of analog input (AI) data
6	Length of analog input (AI) data (in bytes)
7, 8	Starting reference of discrete output (Q) data
9	Length of discrete output (Q) data (in bytes)
10,11	Starting reference of analog output (AQ) data
12	Length of analog output (AQ) data (in bytes)

How a Write Map Datagram Affects I/O Modules in the Station

Receiving a Write Map datagram with different starting addresses and/or lengths changes the memory assigned previously configured for the BIU's network map, as explained above. Because only data included within the map is exchanged on the bus, the BIU responds to such changes in its network map by automatically reassigning the I/O addresses of the modules in the station. This assures that the I/O data will continue to be exchanged on the bus. It is important that the lengths supplied in the Write Map datagram accommodate all of the data that should be exchanged. The data of any modules configured outside the BIU's network map will be scanned by the BIU, but not exchanged on the bus.

For example, suppose an I/O station has three 16-point discrete input modules, originally configured to use addresses I0001 through I0048. All of this input data is included in the BIU's network map and is sent on the bus.

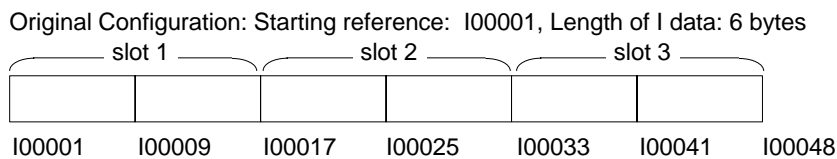

Later, a Write Map datagram is sent to the BIU, specifying a beginning address of I00065 and a length of 5 bytes for I data. The BIU would automatically reassign starting addresses to the I/O modules starting at I00065. However, this would place 8 inputs (I00105 through I00112) outside the network map and the BIU would no longer send those inputs to the host.

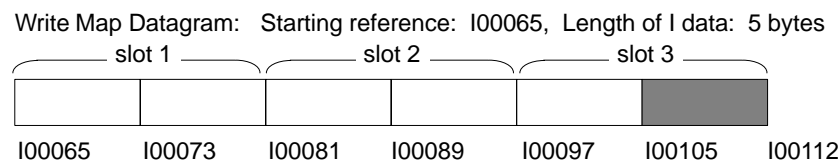

5. REPORT FAULT DATAGRAM FORMAT

The format of Report Fault datagrams sent by a Bus Interface Unit is shown below. The Alspa C80-75 Bus Controller interprets this information automatically; no datagram programming is required.

If the host is a computer, this information can be retrieved from the unsolicited datagram queue and interpreted as needed for the application.

Subfunction Code: 0F hex

Byte No.	Description
0	Fault Byte 1
1	Fault Byte 2
2	Fault byte 3
3	Fault byte 4
4	Fault byte 5
5	Fault byte 6
6	Fault byte 7

5.1. Fault Byte 1

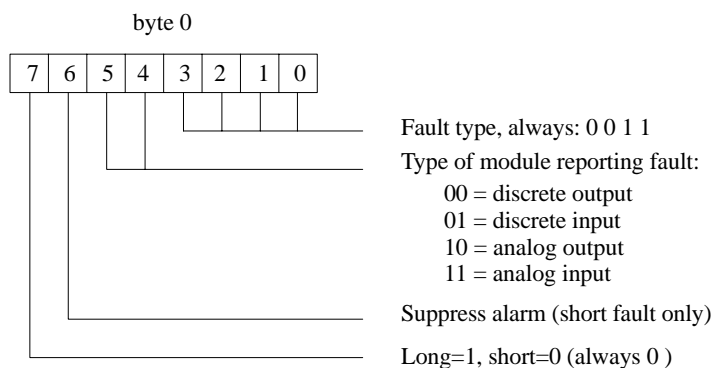

5.2. Fault Byte 2

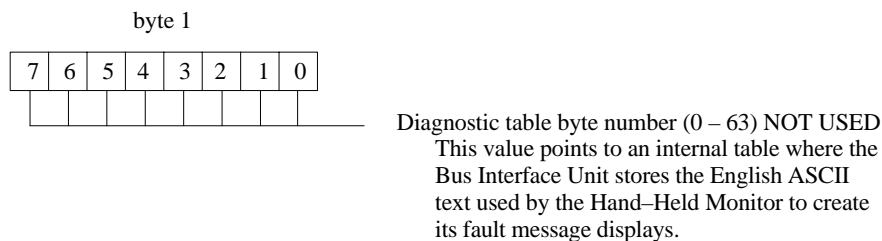

5.3. Fault Byte 3

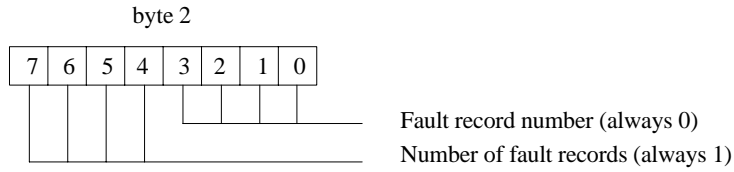

5.4. Fault Bytes 4 and 5

Fault bytes 4 and 5 (bytes 3 and 4 of the datagram) identify the reference offset (within the Bus Interface Unit itself) assigned to the faulted module. This is an internal reference, not an Alspa C80–75 reference.

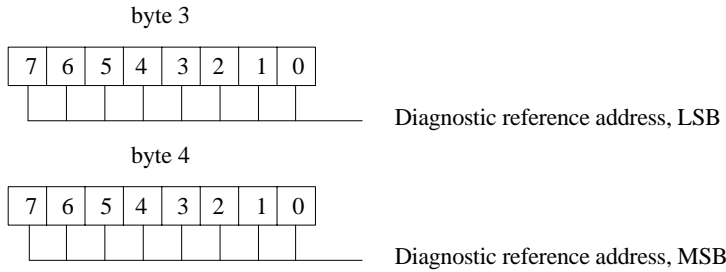

5.5. Fault Bytes 6 and 7

Fault bytes 6 and 7 (datagram bytes 5 and 6) are interpreted by the Alspa C80–75 Bus Controller automatically. They are not relevant to other types of host.

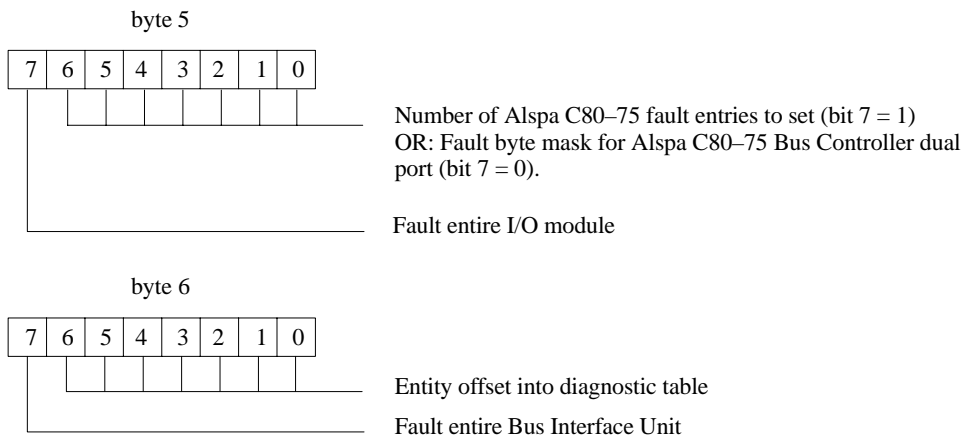

6. CONFIGURATION DATA

For a Bus Interface Unit, the data format of configuration data transferred by Read Configuration Reply and Write Configuration datagrams is slightly different than the format for other N80 devices. Instead of an offset, the data specifies the slot number of a specific device in the Alspa CE80–20 Station. The length specified must exactly match the length of the configuration data for the module (Bus Interface Unit or other module in the station); partial configuration data cannot be read or written. For programming instructions, you will need to refer to the *Bus Controller User's Manual* for the PLC. For the Alspa C80–75 PLC, COMMREQ 15 must be used with a Read Configuration datagram.

Configuration files for conventional Alspa CE80–20 modules can be read or written one module per message. However, the configuration files of intelligent modules may exceed the 128-byte maximum length of a data message. Therefore, any Write Configuration to an intelligent module must be contained within a Begin/End Packet Sequence.

6.1. Read Configuration Data

Subfunction Code: 02 hex

The Read Configuration Datagram is used to read configuration data. The datagram format is different for conventional Alspa CE80–20 modules or intelligent modules.

6.1.1. Read Configuration Data Format for Alspa CE80–20 Conventional Modules

Byte No.	Description
0	Slot number
1	Length (will return minimum 6 bytes to maximum 128 bytes, or specific amount requested. It can be more or less than the configured size for the slot. If more data is requested than is available for a slot, the extra data bytes will contain zeros).

6.1.2. Read Configuration Datagram Format for Alspa CE80–20 Intelligent Modules

Configuration data for the BIU and other intelligent modules is transmitted in packets. Depending on the module type, there can be many packets. Each packet can be up to 128 bytes long.

Byte No	Description
0	Slot number in bottom nibble, Intelligent Packet in upper nibble. Examples: 01(hex) reads packet 0 of intelligent module in slot 1 11(hex) reads packet 1 of intelligent module in slot 1.
1	Length in bytes (maximum per packet is 128)
2	(optional). If the slot number is 0 (the location of the BIU) and this byte is not included or if it is set to FF(hex), the BIU configuration is returned. If this byte is set to 01(hex) through 10(hex), the appropriate group information is returned.

6.2. Read Configuration Reply Data

Subfunction Code: 03 hex

This datagram is a reply to the Read Configuration datagram. The following pages show the formats of configuration data for Alspa CE80–20 devices.

Byte No	Description
0	Slot (corresponds to slot supplied in Read Configuration message)
1	Length (depends on module type)
2–N	Data format shown on the following pages

6.3. Write Configuration Data

Subfunction Code: 04 hex

The Write Configuration datagram is used to send configuration data. Content of the data is the same as the Read Configuration Reply. Do not send partial configuration data.

6.3.1. Write Configuration Data Format for Alspa CE80–20 Conventional Modules

Byte No.	Description
0	Slot (Bus Interface Unit is 0)
1	Length (must match the length for the specific device whose configuration will be written).
2–N	Data format shown on the following pages

Use the Begin and End Packet sequence messages to ensure that a sequence of Write Configuration messages is treated as a single entity. Each packet should be in slot order. Multiple packets for a slot must also be in order. Multiple packets must be 128 bytes in length except the last which may be shorter.

Example:

Begin Packet Sequence	(subfunction code 06 hex)
Write Configuration 1	(subfunction code 04 hex)
Write Configuration 2	
Write Configuration N	
End Packet Sequence	(subfunction code 07 hex). This contains the total number of BYTES in all Write Configuration packets. For Alspa CE80–20 (only) the End Packet Sequence has 2 bytes. Byte 0 is the least significant byte of the data length and byte 1 is the most significant.

6.3.2. Write Configuration Datagram Format for Alspa CE80–20 Intelligent Modules

When using the Write Configuration datagram to configure Group Moves, the datagram format is:

Byte No	Description
0	Slot number in bottom nibble, Intelligent Packet in upper nibble. Examples: 01(hex) writes packet 0 to intelligent module in slot 1 11(hex) writes packet 1 to intelligent module in slot 1.
1	Length sent, in bytes (maximum per packet is 128)
2	(optional). If the slot number is 0 (the location of the BIU) and this byte is not included or if it is set to FF(hex), the BIU configuration is written. If this byte is set to 01(hex) through 10(hex), the appropriate group information is written.

6.3.3. Bus Interface Unit Configuration Data Format

For the Bus Interface Unit, the slot number is 0 and the length varies.

Bytes 0 to 11 must be: FF hex, 0,0,0,0,0,0,0,0,0,0

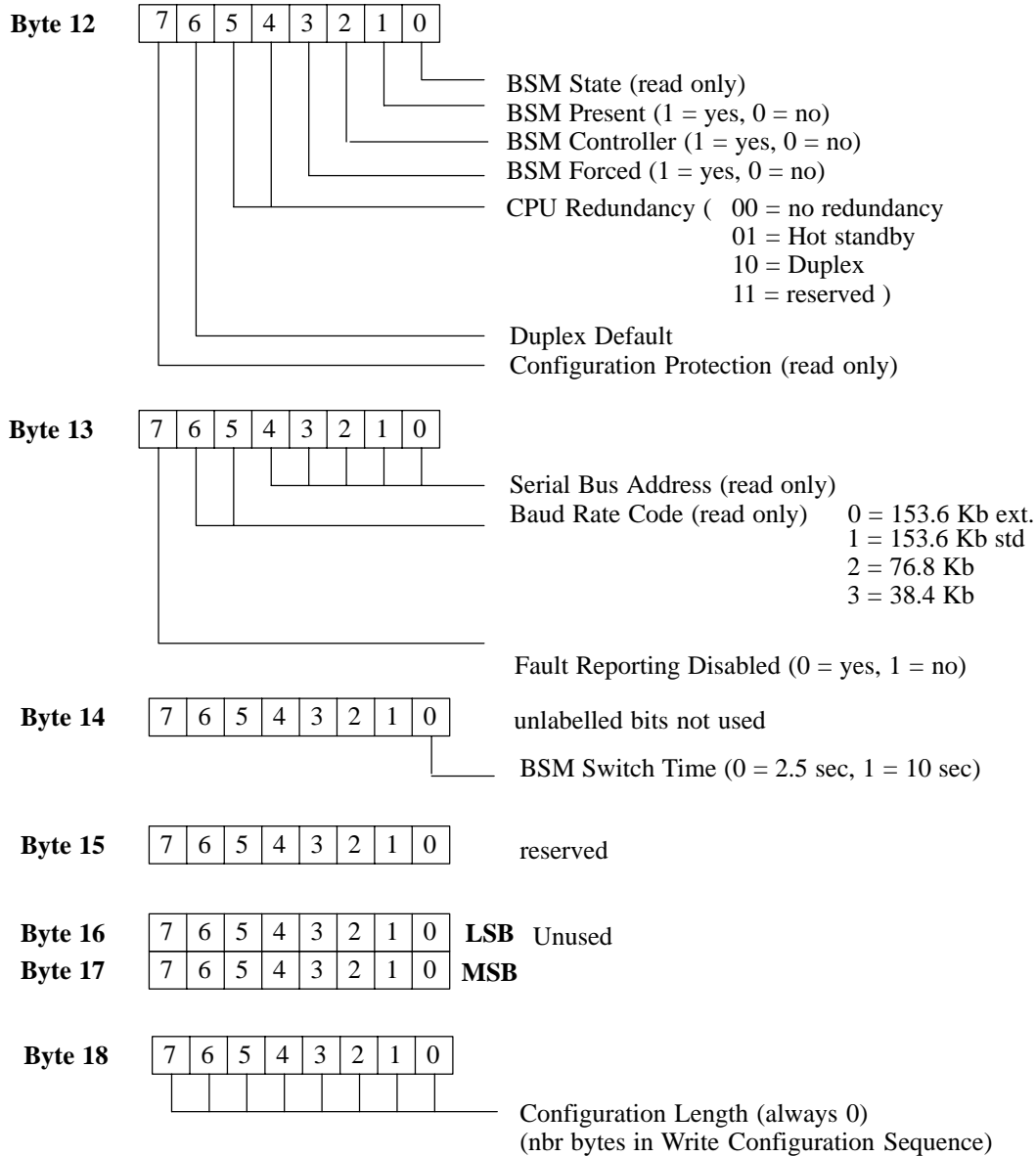

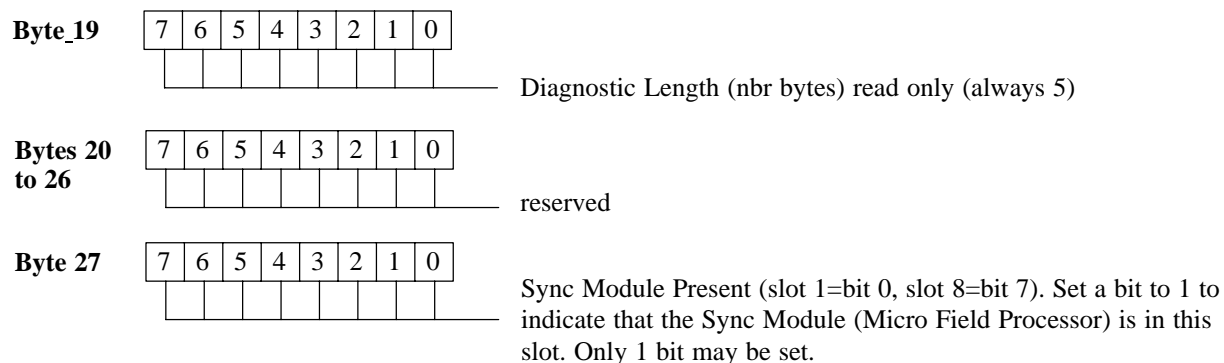

6.3.4. Discrete Input Modules Configuration Data Format

Specify the actual slot number and a length of 13.

The reference address is the location in the BIU's I, Q, AI or AQ memory that is used by the module's data. Specify only one address, typically in the discrete input (I) table. Set the other address selection bytes to all zeros.

Bytes 0 to 3 must be: 45 hex, 0,0,0

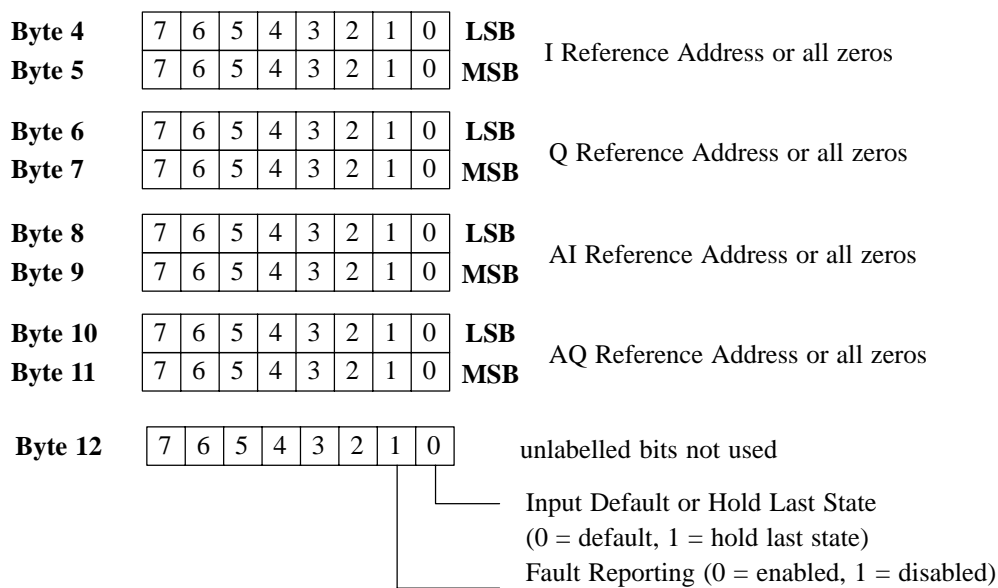

6.3.5. Discrete Output Modules Configuration Data Format

Specify the actual slot number and a length of 30.

The reference address is the location in the BIU's I, Q, AI or AQ memory that is used by the module's data. Specify only one address, typically in the discrete output (Q) table. Set the other address selection bytes to all zeros.

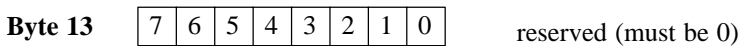
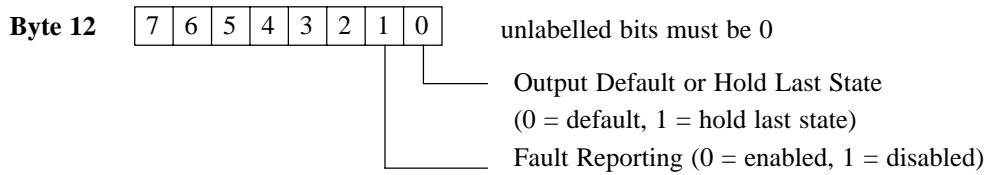
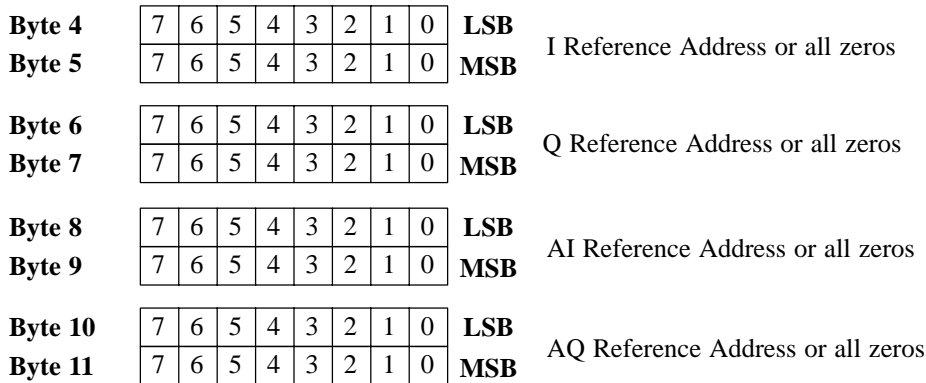

Bytes 14 to 29: Circuit Configuration. For each circuit, content is:

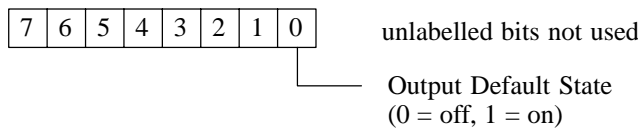

(Byte No.)	Byte Description	(Byte No.)	Byte Description
14	Circuit 1 Configuration	22	Circuit 9 Configuration
15	Circuit 2 Configuration	23	Circuit 10 Configuration
16	Circuit 3 Configuration	24	Circuit 11 Configuration
17	Circuit 4 Configuration	25	Circuit 12 Configuration
18	Circuit 5 Configuration	26	Circuit 13 Configuration
19	Circuit 6 Configuration	27	Circuit 14 Configuration
20	Circuit 7 Configuration	29	Circuit 15 Configuration
21	Circuit 8 Configuration	29	Circuit 16 Configuration

6.3.6. Discrete Combination Input/Output Modules Configuration Data Format

Specify the actual slot number and a length of 20.

Entering the Reference Addresses

The reference addresses are the locations in the BIU's I, Q, AI or AQ memory used by the module's data. In this module configuration only, the input reference is the first non-zero entry **WITHOUT** the corresponding bit set in byte 12 (see below) The output reference is the first non-zero entry **WITH** the corresponding bit set. In byte 12, bits 4, 5, 6 and 7 define the input reference. For example, if bit 6 of byte 12 is set to 1 and a reference is specified in bytes 8 and 9, inputs for the module will be mapped to the AI table. Note that the entries must correspond properly or the BIU will reject the module configuration. In a normal configuration for a combination discrete module, inputs go to the I table and outputs go to the Q table. In that case, you enter the input reference in bytes 4/5 and the output reference in bytes 6/7 and set bit 4 of byte 12 to 1. All other reference address bytes and other input reference bits (in byte 12) must be set to zero.

Bytes 0 to 3 must be: 21 hex, 0,0,0

Byte 4	7	6	5	4	3	2	1	0	LSB	I Reference Address or all zeros
Byte 5	7	6	5	4	3	2	1	0	MSB	
Byte 6	7	6	5	4	3	2	1	0	LSB	Q Reference Address or all zeros
Byte 7	7	6	5	4	3	2	1	0	MSB	
Byte 8	7	6	5	4	3	2	1	0	LSB	AI Reference Address or all zeros
Byte 9	7	6	5	4	3	2	1	0	MSB	
Byte 10	7	6	5	4	3	2	1	0	LSB	AQ Reference Address or all zeros
Byte 11	7	6	5	4	3	2	1	0	MSB	

Byte 12	7	6	5	4	3	2	1	0	unlabelled bit must be 0
									Input Default or Hold Last State (0 = default, 1 = hold last state)
									Fault Reporting (0 = enabled, 1 = disabled)
									Output Default or Hold Last State
									Input Reference is I table
									Input Reference is Q Table
									Input Reference is AI Table
									Input Reference is AQ Table

Byte 13 7 6 5 4 3 2 1 0 reserved (must be 0)

Bytes 14 to 19: Output Circuit Configuration. For each output, content is:

7	6	5	4	3	2	1	0	unlabelled bits must be 0
								Output Default State (0 = off, 1 = on)

(Byte No.)	Byte Description
14	Output 1 Configuration
15	Output 2 Configuration
16	Output 3 Configuration
17	Output 4 Configuration
18	Output 5 Configuration
19	Output 6 Configuration

6.3.7. Conventional Analog Input Modules Configuration Data Format

Specify the actual slot number and a length of 126.

The reference address is the location in the BIU's I, Q, AI or AQ memory that is used by the module's data. Specify only one address, typically in the analog input (AI) table. Set the other address selection bytes to all zeros.

For current module, bytes 0 to 3 must be: 32 hex, 0,0,0

For voltage module, bytes 0 to 3 must be: 34 hex, 0,0,0

Byte 4	7	6	5	4	3	2	1	0	LSB	I Reference Address or all zeros
Byte 5	7	6	5	4	3	2	1	0	MSB	
Byte 6	7	6	5	4	3	2	1	0	LSB	Q Reference Address or all zeros
Byte 7	7	6	5	4	3	2	1	0	MSB	
Byte 8	7	6	5	4	3	2	1	0	LSB	AI Reference Address or all zeros
Byte 9	7	6	5	4	3	2	1	0	MSB	
Byte 10	7	6	5	4	3	2	1	0	LSB	AQ Reference Address or all zeros
Byte 11	7	6	5	4	3	2	1	0	MSB	

Byte 12	7	6	5	4	3	2	1	0	unlabelled bits must be 0
									Input Default or Hold Last Value (0 = default, 1 = hold last value)

Byte 13	7	6	5	4	3	2	1	0	reserved
----------------	---	---	---	---	---	---	---	---	----------

Bytes 14, 28, 42, 56, 70, 84, 98, 112 (see below)

7	6	5	4	3	2	1	0	unlabelled bits must be 0
								Fault Reporting (0 = enabled, 1 = disabled)
								Channel Active (0 = active, 1 = inactive)
								Range: 00 = 0 mA to 20 mA
								01 = 4 mA to 20 mA
								10 = 0 V to 10 V
								11 = -10 V to +10 V

Bytes 14 – 125: Channel Configuration

(Byte No.)	Byte Description	(Byte No.)	Byte Description
14 15 16, 17 18, 19 20, 21 22, 23 24, 25 26, 27	Input 1: circuit configuration (see above) reserved low scaling point, eng. units (lsb in byte 16) high scaling point, eng. units (lsb in byte 18) low scaling point, digital counts (lsb in byte 20) high scaling point, digital counts (lsb in byte 22) low alarm limit (lsb in byte 24) high alarm limit (lsb in byte 26)	70 71 72, 73 74, 75 76, 77 78, 79 80, 81 82, 83	Input 5: circuit configuration (see above) reserved low scaling point, eng. units (lsb in byte 72) high scaling point, eng. units (lsb in byte 74) low scaling point, digital counts (lsb in byte 76) high scaling point, digital counts (lsb in byte 78) low alarm limit (lsb in byte 80) high alarm limit (lsb in byte 82)
28 29 30, 31 32, 33 34, 35 36, 37 38, 39 40, 41	Input 2: circuit configuration (see above) reserved low scaling point, eng. units (lsb in byte 30) high scaling point, eng. units (lsb in byte 32) low scaling point, digital counts (lsb in byte 34) high scaling point, digital counts (lsb in byte 36) low alarm limit (lsb in byte 38) high alarm limit (lsb in byte 40)	84 85 86, 87 88, 89 90, 91 92, 93 94, 95 96, 97	Input 6: circuit configuration (see above) reserved low scaling point, eng. units (lsb in byte 86) high scaling point, eng. units (lsb in byte 88) low scaling point, digital counts (lsb in byte 90) high scaling point, digital counts (lsb in byte 92) low alarm limit (lsb in byte 94) high alarm limit (lsb in byte 96)
42 43 44, 45 46, 47 48, 49 50, 51 52, 53 54, 55	Input 3: circuit configuration (see above) reserved low scaling point, eng. units (lsb in byte 44) high scaling point, eng. units (lsb in byte 46) low scaling point, digital counts (lsb in byte 48) high scaling point, digital counts (lsb in byte 50) low alarm limit (lsb in byte 52) high alarm limit (lsb in byte 54)	98 99 100, 101 102, 103 104, 105 106, 107 108, 109 110, 111	Input 7: circuit configuration (see above) reserved low scaling point, eng. units (lsb in byte 100) high scaling point, eng. units (lsb in byte 102) low scaling point, digital counts (lsb in byte 104) high scaling point, digital counts (lsb in byte 106) low alarm limit (lsb in byte 108) high alarm limit (lsb in byte 110)
56 57 58, 59 60, 61 62, 63 64, 65 66, 67 68, 69	Input 4: circuit configuration (see above) reserved low scaling point, eng. units (lsb in byte 58) high scaling point, eng. units (lsb in byte 60) low scaling point, digital counts (lsb in byte 62) high scaling point, digital counts (lsb in byte 64) low alarm limit (lsb in byte 66) high alarm limit (lsb in byte 68)	112 113 114, 115 116, 117 118, 119 120, 121 122, 123 124, 125	Input 8: circuit configuration (see above) reserved low scaling point, eng. units (lsb in byte 114) high scaling point, eng. units (lsb in byte 116) low scaling point, digital counts (lsb in byte 118) high scaling point, digital counts (lsb in byte 120) low alarm limit (lsb in byte 122) high alarm limit (lsb in byte 124)

6.3.8. Analog Output Modules Configuration Data Format

Specify the actual slot number and a length of 62.

The reference address is the location in the BIU's I, Q, AI or AQ memory that is used by the module's data. Specify only one address, typically in the analog input (AI) table. Set the other address selection bytes to all zeros.

Bytes 0 to 3 must be: 33 hex, 0,0,0

Byte 4	7	6	5	4	3	2	1	0	LSB	I Reference Address or all zeros
Byte 5	7	6	5	4	3	2	1	0	MSB	
Byte 6	7	6	5	4	3	2	1	0	LSB	Q Reference Address or all zeros
Byte 7	7	6	5	4	3	2	1	0	MSB	
Byte 8	7	6	5	4	3	2	1	0	LSB	AI Reference Address or all zeros
Byte 9	7	6	5	4	3	2	1	0	MSB	
Byte 10	7	6	5	4	3	2	1	0	LSB	AQ Reference Address or all zeros
Byte 11	7	6	5	4	3	2	1	0	MSB	

Byte 12	7	6	5	4	3	2	1	0	unlabelled bits must be 0
									Output Default or Hold Last Value (0 = default, 1 = hold last value)

Byte 13	7	6	5	4	3	2	1	0	reserved (must be 0)
----------------	---	---	---	---	---	---	---	---	----------------------

Bytes 14, 26, 38, 50 (see below)

7	6	5	4	3	2	1	0	unlabelled bits must be 0
								Fault Reporting (0 = enabled, 1 = disabled)
								Channel Active (0 = active, 1 = inactive)
								Range: 00 = 0 mA to 20 mA 01 = 4 mA to 20 mA 10 = 0 V to 10 V 11 = -10 V to +10 V

Bytes 14 – 61: Channel Configuration

(Byte No.)	Byte Description	(Byte No.)	Byte Description
14	Input 1: circuit configuration (see above)	38	Input 3: circuit configuration (see above)
15	reserved	39	reserved
16, 17	low scaling point, eng. units (lsb in byte 16)	40, 41	low scaling point, eng. units (lsb in byte 40)
18, 19	high scaling point, eng. units (lsb in byte 18)	42, 43	high scaling point, eng. units (lsb in byte 42)
20, 21	low scaling point, digital counts (lsb in byte 20)	44, 45	low scaling point, digital counts (lsb in byte 44)
22, 23	high scaling point, digital counts (lsb in byte 22)	46, 47	high scaling point, digital counts (lsb in byte 46)
24, 25	output default value (lsb in byte 24)	48, 49	output default value (lsb in byte 48)
26	Input 2: circuit configuration (see above)	50	Input 4: circuit configuration (see above)
27	reserved	51	reserved
28, 29	low scaling point, eng. units (lsb in byte 28)	52, 53	low scaling point, eng. units (lsb in byte 52)
30, 31	high scaling point, eng. units (lsb in byte 30)	54, 55	high scaling point, eng. units (lsb in byte 54)
32, 33	low scaling point, digital counts (lsb in byte 32)	56, 57	low scaling point, digital counts (lsb in byte 56)
34, 35	high scaling point, digital counts (lsb in byte 34)	58, 59	high scaling point, digital counts (lsb in byte 58)
36, 37	output default value (lsb in byte 36)	60, 61	output default value (lsb in byte 60)

6.3.9. Intelligent Modules Configuration Data Format

Configuration files of intelligent modules may exceed the 128-byte maximum length of a N80 message. Therefore, any Write Configuration to an intelligent module must be contained within a Begin/End Packet Sequence. The BIU rejects any Write Configuration message for an intelligent module that does not follow a Begin Packet message.

Write Configuration for an intelligent module may be packetized by using the upper nibble of the slot byte to indicate a packet number. Data for packets greater than zero is assumed to have an offset with a slot configuration of (packet_number*128). Therefore, all packets except the last must have 128 bytes.

Note that all reserved or unused bits must be 0.

6.3.9.1. Configuration Data for Intelligent Modules, Bytes 0 to 13

The first 13 bytes of configuration data for intelligent modules have the content shown below. Each intelligent module has additional configuration data listed on the following pages.

Byte	Meaning	Intelligent Analog Modules (IC670...)							Micro Field Processor (IC670MFP100)																																																																																
		ALG 240	ALG 281	ALG 282	ALG 310	ALG 330	ALG 620	ALG 630																																																																																	
0	intelligent module board ID	1Fh																																																																																							
1	reserved must be 0	0																																																																																							
2	unique module identifier	1	8	7	6	5	2	3	4																																																																																
3	reserved must be 0	0																																																																																							
4	reference types word (bit 0 = 1 means inputs available, bit 1 = 1 means outputs available, both = 1 means inputs and outputs available)	3 (bits 0 and 1 both set to 1)	3	3	3	3	3	3	3																																																																																
5	reserved must be 0	0																																																																																							
6, 7	length of module's configuration file in bytes	248	136	248	106	106	84	174	30																																																																																
8, 9	reserved must be 0	0																																																																																							
10, 11	reserved must be 0	0																																																																																							
12	input/output hold last state/default to 0. Bits are shown below. For each, 0 = default, 1=hold last state.	<table border="0"> <tr> <td style="border: 1px solid black; padding: 2px;">7</td> <td style="border: 1px solid black; padding: 2px;">6</td> <td style="border: 1px solid black; padding: 2px;">5</td> <td style="border: 1px solid black; padding: 2px;">4</td> <td style="border: 1px solid black; padding: 2px;">3</td> <td style="border: 1px solid black; padding: 2px;">2</td> <td style="border: 1px solid black; padding: 2px;">1</td> <td style="border: 1px solid black; padding: 2px;">0</td> <td colspan="2"></td> </tr> <tr> <td colspan="8"></td> <td colspan="2">BSM State (read only)</td> </tr> <tr> <td colspan="8"></td> <td colspan="2">BSM Present (1 = yes, 0 = no)</td> </tr> <tr> <td colspan="8"></td> <td colspan="2">BSM Controller (1 = yes, 0 = no)</td> </tr> <tr> <td colspan="8"></td> <td colspan="2">BSM Forced (1 = yes, 0 = no)</td> </tr> <tr> <td colspan="8"></td> <td colspan="2">CPU Redundancy (00 = no redundancy 01 = Hot standby 10 = Duplex 11 = reserved)</td> </tr> <tr> <td colspan="8"></td> <td colspan="2">Duplex Default</td> </tr> <tr> <td colspan="8"></td> <td colspan="2">Configuration Protection (read only)</td> </tr> </table>								7	6	5	4	3	2	1	0											BSM State (read only)										BSM Present (1 = yes, 0 = no)										BSM Controller (1 = yes, 0 = no)										BSM Forced (1 = yes, 0 = no)										CPU Redundancy (00 = no redundancy 01 = Hot standby 10 = Duplex 11 = reserved)										Duplex Default										Configuration Protection (read only)	
7	6	5	4	3	2	1	0																																																																																		
								BSM State (read only)																																																																																	
								BSM Present (1 = yes, 0 = no)																																																																																	
								BSM Controller (1 = yes, 0 = no)																																																																																	
								BSM Forced (1 = yes, 0 = no)																																																																																	
								CPU Redundancy (00 = no redundancy 01 = Hot standby 10 = Duplex 11 = reserved)																																																																																	
								Duplex Default																																																																																	
								Configuration Protection (read only)																																																																																	
13	reserved must be 0	0																																																																																							
14-n	additional module data																																																																																								

6.3.9.2. Additional Configuration Data for a 16 Point Grouped Analog Input Module

The content of configuration data bytes 14 to 261 for a 16 Point Grouped Analog Input module (IC670ALG240) is listed below.

See Subsection 6.3.9.1. for the content of bytes 0 to 13.

yte	De p t o	yte	De p t o
14	Number of input reference parameters (2)	40, 41	Ch1 Low Span (0 to 25000)
15	Number of output reference parameters (1)	42, 43	Ch1 High Span (0 to 25000)
16, 17	Byte length of analog input data (default is 32)	44, 45	Ch 1 Low Eng. Units (-32768 to +32767)
18, 19	Memory type for the module's analog input data, usually type AI. Enter one of the following numbers: 16 = I table 18 = Q table 10 = AI table 12 = AQ table	46, 47	Ch 1 High Eng. Units (-32768 to +32767)
20, 21	Relative offset from start of table	48, 49	Ch1 Low Alarm
22, 23	Byte length of discrete diagnostic input data (default is 11)	50, 51	Ch1 High Alarm
24, 25	Memory type for the module's diagnostic input bits, usually type I. Enter one of the numbers listed above.	52-65	Ch 2 parameters
26, 27	Relative offset from start of table	66-79	Ch 3 parameters
28, 29	Byte length of module's control output bits	80-93	Ch 4 parameters
30, 31	Memory type for the module's control output bits, usually type Q. Enter one of the numbers listed above.	94-107	Ch 5 parameters
32, 33	Relative offset from start of table	108-121	Ch 6 parameters
34 (bit 4)	Line Frequency (0 = 50 Hz, 1 = 60 Hz)	122-135	Ch 7 parameters
34 (bits 0,1)	Filtering Method (0 = None, 1 = 8 average, 2 = 16 average)	136-149	Ch 8 parameters
35	reserved	150-163	Ch 9 parameters
36, 37	Active Channel Bit Map 1 bit per channel	164-177	Ch 10 parameters
38, 39	Ch1 Range: 0 no preselected range 1 span 4000 to 20000, units 4000 to 20000 2 span 4000 to 20000, units 0 to 32000 3 span 0 to 20000, units 0 to 32000 4 span 0 to 24000, units 0 to 32000 Read-only when sending a configuration file. The module sets the range based on the scaling parameters. When the configuration is read back, it indicates the correct range.	178-191	Ch 11 parameters
		192-205	Ch 12 parameters
		206-219	Ch 13 parameters
		220-233	Ch 14 parameters
		234-247	Ch 15 parameters
			Ch 16 parameters

6.3.9.3. Additional Configuration Data for an 8 Point Grouped Analog Voltage Input Module (ALG281)

The content of configuration data bytes 14 to 149 for an 8 Point Grouped Analog Voltage Input module (IC670ALG281) is listed below.

See Subsection 6.3.9.1. for the content of bytes 0 to 13.

Byte	Description	Byte	Description
14	Number of input reference parameters (2)	40, 41	Ch1 Low Span (-10000 to +10000)
15	Number of output reference parameters (1)	42, 43	Ch1 High Span (-10000 to +10000)
16, 17	Byte length of analog input data (default is 16)	44, 45	Ch 1 Low Eng. Units (-32768 to +32767)
18, 19	Memory type for the module's analog input data, usually type AI. Enter one of the following numbers: 16 = I table 18 = Q table 10 = AI table 12 = AQ table	46, 47	Ch 1 High Eng. Units (-32768 to +32767)
20, 21	Relative offset from start of table	48, 49	Ch1 Low Alarm
22, 23	Byte length of discrete diagnostic input data (default is 5)	50, 51	Ch1 High Alarm
24, 25	Memory type for the module's diagnostic input bits, usually type I. Enter one of the numbers listed above.	52-65	Ch 2 parameters
26, 27	Relative offset from start of table	66-79	Ch 3 parameters
28, 29	Byte length of module's control output bits (default is 1)	80-93	Ch 4 parameters
30, 31	Memory type for the module's control output bits, usually type Q. Enter one of the numbers listed above.	94-107	Ch 5 parameters
32, 33	Relative offset from start of table	108-121	Ch 6 parameters
34 (bit 4)	Line Frequency (0 = 50 Hz, 1 = 60 Hz)	122-135	Ch 7 parameters
34 (bits 0,1)	Filtering Method (0 = None, 1 = 10 ms, 2 = 20 ms)	136-149	Ch 8 parameters
35	reserved		
36, 37	Active Channel Bit Map 1 bit per channel		
38, 39	Ch1 Range: 1 span -10000 mV to +10000 mV 2 span 0 mV to +10000 mV		

6.3.9.4. Additional Configuration Data for a 16 Point Grouped Analog Voltage Input Module (ALG282)

The content of configuration data bytes 14 to 261 for a 16 Point Grouped Analog Voltage Input module (IC670ALG282) is listed below.

See Subsection 6.3.9.1. for the content of bytes 0 to 13.

Byte	Description	Byte	Description
14	Number of input reference parameters (2)	40, 41	Ch1 Low Span (-10000 to +10000)
15	Number of output reference parameters (1)	42, 43	Ch1 High Span (-10000 to +10000)
16, 17	Byte length of analog input data (default is 32)	44, 45	Ch 1 Low Eng. Units (-32768 to +32767)
18, 19	Memory type for the module's analog input data, usually type AI. Enter one of the following numbers: 16 = I table 18 = Q table 10 = AI table 12 = AQ table	46, 47	Ch 1 High Eng. Units (-32768 to +32767)
20, 21	Relative offset from start of table	48, 49	Ch1 Low Alarm
22, 23	Byte length of discrete diagnostic input data (default is 9)	50, 51	Ch1 High Alarm
24, 25	Memory type for the module's diagnostic input bits, usually type I. Enter one of the numbers listed above.	52-65	Ch 2 parameters
26, 27	Relative offset from start of table	66-79	Ch 3 parameters
28, 29	Byte length of module's control output bits (default is 2)	80-93	Ch 4 parameters
30, 31	Memory type for the module's control output bits, usually type Q. Enter one of the numbers listed above.	94-107	Ch 5 parameters
32, 33	Relative offset from start of table	108-121	Ch 6 parameters
34 (bit 4)	Line Frequency (0 = 50 Hz, 1 = 60 Hz)	122-135	Ch 7 parameters
34 (bits 0,1)	Filtering Method (0 = None, 1 = 10 ms, 2 = 20 ms)	136-149	Ch 8 parameters
35	reserved	150-163	Ch 9 parameters
36, 37	Active Channel Bit Map 1 bit per channel	164-177	Ch 10 parameters
38, 39	Ch1 Range: 1 span -10000 mV to +10000 mV 2 span 0m V to +10000mV	178-191	Ch 11 parameters
		192-205	Ch 12 parameters
		206-219	Ch 13 parameters
		220-233	Ch 14 parameters
		234-247	Ch 15 parameters
		248-261	Ch 16 parameters

6.3.9.5. Additional Configuration Data for an RTD Input Module

The content of configuration data bytes 14 to 97 for an RTD Input module (IC670ALG620) is listed below. See Subsection 6.3.9.1. for the content of bytes 0 to 13.

Byte	Description	Byte	Description
14	Number of input reference parameters (2)	46, 47	RTD type for input 1: 0 = 10 Ohm, Pt L&N 1 = 25 Ohm, Pt IPTS-68 2 = 25.5 Ohm, Pt at 0 deg. C Lab Std, alpha = 0.00392 3 = 100 Ohm, Pt, DIN43760, alpha= 0.00385 4 = 100 Ohm Pt, Burns-Special, alpha= 0.003902 5 = 100 Ohm Pt, IPTS-68, alpha= 0.00392 6 = 98.13 Ohm Pt, SAMA-RC21-4, alpha= 0.003923 7 = 100 Ohm Pt, JISC-1604-'81, alpha= 0.003916 8 = 1K Ohm Pt, alpha= 0.00375 9 = 10 Ohm Cu at 25 deg. C IPTS-68 10 = 9.035 Ohm, Cu at 25 deg. C, alpha= 0.00427 11 = 50 Ohm, Cu, alpha= 0.00427 12 = 100 Ohm Cu, alpha= 0.00427 13 = 100 Ohm Ni IPTS-68 14 = 100 Ohm Ni at 0 deg C DIN43760, alpha= 0.00618 15 = 120 Ohm Ni at 0 deg. C, alpha= 0.00672 16 = 604 Ohm Ni/Fe at 0 deg. F, alpha= 0.00518 17 = 1K Ohm, Ni/Fe at 70 deg. F, alpha= 0.00527 18 = 500 Ohm span, requires conversion type 0 19 = 3000 Ohm span, requires conversion type 0 20 =none
15	Number of output reference parameters (2)		
16, 17	Byte length of analog input data (0 – 8)		
18, 19	Memory type for the module's analog input data, usually type AI. Enter one of the following numbers: 18 = Q table 10 = AI table 12 = AQ table		
20, 21	Relative offset from start of table		
22, 23	Byte length of discrete diagnostic input data (0 – 4)		
24, 25	Memory type for the module's diagnostic input bits, usually type I. Enter one of the numbers listed above.		
26, 27	Relative offset from start of table		
28, 29	Byte length of control output bits (0 or 1)		
30, 31	Memory type for the module's control output bits, usually type Q. Enter one of the numbers listed above.		
32, 33	Relative offset from start of table		
34, 35	Byte length of analog output data (should be set to 0)	48, 49	Wire type for input 1 (0 = 3 wire, 1 = 4 wire)
36, 37	Memory type for the module's analog output bits. Not used.	50, 51	Low Alarm for input 1 (-32767 to +32767)
38, 39	Relative offset from start of table	52, 53	High Alarm for input 1 (-32767 to +32767)
40, 41	Line Frequency (0 = 50 Hz, 1 = 60 Hz)	54, 55	Offset for input 1 (0 to 32767)
42, 43	Channel Active flag for input 1 (0 = inactive, 1 = active)	56-69	Ch 2 parameters
44, 45	Conversion type for input 1: 0 = 1/10 ohms, 1 = linearized temperature in 1/10 degrees C, 2 = linearized temperature in 1/10 degrees F, 3 = percent of span	70-83	Ch 3 parameters
		84-97	Ch 4 parameters

6.3.9.6. Additional Configuration Data for a Thermocouple Input Module

The content of configuration data bytes 14 to 187 for a Thermocouple module (IC670ALG630) is listed below. See Subsection 6.3.9.1. for the content of bytes 0 to 13.

Byte	Description	Byte	Description
14	Number of input reference parameters (2)	48, 49	Thermocouple type for input 1 (only used for conversion types 1 & 2 (see bytes 46, 47) 0 = none 8 = N 1 = J 9 = G 2 = K 10 = C 3 = T 11 = D 4 = E 12 = Platinel II 5 = S 13 = non-standard TC 1 6 = R 14 = non-standard TC 2
15	Number of output reference parameters (2)		
16, 17	Byte length of analog input data		
18, 19	Memory type for the module's analog input data, usually type AI. Enter one of the following numbers: 16 = I table 18 = Q table 10 = AI table 12 = AQ table		
20, 21	Relative offset from start of table	50, 51	Range type for input 1. This is used ONLY if range type (see bytes 48, 49) is set to 0. 0 = unused 4 = 156 mV 1 = 19.5 mV 5 = 312.5 mV 2 = 39 mV 6 = 625 mV 3 = 78 mV
22, 23	Byte length of discrete diagnostic input data		
24, 25	Memory type for the module's diagnostic input bits, usually type I. Enter one of the numbers listed above.		
26, 27	Relative offset from start of table	52, 53	Remote Junction Compensation for input 1 : 0 = none 1 = use local thermistor 2 = use a value supplied in the module's analog output (AQ) data 3 = use the configured value (bytes 58, 59)
28, 29	Byte length of discrete control output data	54, 55	Low Alarm for input 1 (-32767 to +32767)
30, 31	Memory type for the module's control output bits, usually type Q. Enter one of the numbers listed above.	56, 57	High Alarm for input 1 (-32767 to +32767)
32, 33	Relative offset from start of table	58, 59	Remote Junction value for input 1. Used only if Remote Junction Compensation (bytes 52, 53) is 3. The module multiplies this value by 100 then adds it to the input voltage before performing linearization. (-327.67 to +327.67).
34, 35	Byte length of analog output data (for cold junction compensation), usually type AQ		
36, 37	Memory type for the module's analog output data (used for remote junction compensation). Usually type AQ. Enter one of the numbers listed above.		
38, 39	Relative offset from start of table	60, 61	Offset for input 1. Used if conversion type (bytes 46, 47) is degrees C or F. This value should be in the same units. The module multiplies the value by 100 before using it. Range is -100.00 to +100.00 degrees.
40, 41	Line Frequency (0 = 50 Hz, 1 = 60 Hz)	62 – 79	Ch 2 parameters
42, 43	Open circuit checking suppression for input 1 (0 = perform check, 1 = suppress check)	80 – 97	Ch 3 parameters
44, 45	Channel active for input 1 (0 = inactive, 1 = active)	98 - 115	Ch 4 parameters
46, 47	Conversion type for input 1: 0 = 1/100 millivolts 1 = linearized temperature in 1/10 degrees C 2 = linearized temperature in 1/10 degrees F 3 = percent of span (fractional format)	116 - 133	Ch 5 parameters
		134 -151	Ch 6 parameters
		152 - 169	Ch 7 parameters
		170 - 187	Ch 8 parameters

6.3.9.7. Additional Configuration Data for a Current Source Analog Output Module

The content of configuration data bytes 14 to 119 for a Current Source Analog Output module (IC670ALG330) is listed below.

See Subsection 6.3.9.1. for the content of bytes 0 to 13.

Byte	Description	Byte	Description
14	Number of input reference parameters (1)	40, 41	Ch1 Range: 0 no preselected range 1 span 4000 to 20000, units 4000 to 20000 2 span 4000 to 20000, units 0 to 32000 3 span 0 to 20000, units 0 to 32000 If the range is not 0, the span and engineering units (entered in the following eight bytes) must match the selected range. If they do not, the module will reject the configuration. If the range is 0, the span and engineering units are not used and the next eight bytes are not checked.
15	Number of output reference parameters (2)		
16, 17	Byte length of diagnostic discrete input data (0 – 4)		
18, 19	Memory type for the module's diagnostic input bits, usually type I. Enter one of the following numbers: 16 = I table 18 = Q table 10 = AI table 12 = AQ table		
20, 21	Relative offset from start of table	42, 43	Ch 1 Low Eng. Units (–32768 to +32767)
22, 23	Byte length of the module's analog output data (0 – 16)	44, 45	Ch 1 High Eng. Units (–32768 to +32767)
24, 25	Memory type for the module's analog output data, usually type AQ. Enter one of the numbers listed above.	46, 47	Ch1 Low Span (0 to 20000, <=high)
26, 27	Relative offset from start of table	48, 49	Ch1 High Span (0 to 20000, >=low)
28, 29	Byte length of module's control output bits (0 – 2)	50 – 59	Ch 2 parameters
30, 31	Memory type for the module's control output bits, usually type Q. Enter one of the numbers listed above.	60 – 69	Ch 3 parameters
32, 33	Relative offset from start of table.	70 – 79	Ch 4 parameters
34, 35	Local Default Output (0 = off, 1 = hold)	80 – 89	Ch 5 parameters
36, 37	BIU command timeout in milliseconds (500 to 65535)	90 – 99	Ch 6 parameters
38, 39	Active Channels. One bit per channel. For each channel (0 = inactive, 1 = active). Default is 0xFF, all active.	100 - 109	Ch 7 parameters
		110 - 119	Ch 8 parameters

6.3.9.8. Additional Configuration Data for an Analog Voltage Output Module

The content of configuration data bytes 14 to 119 for an Analog Voltage Output module (IC670ALG310) is listed below.

Byte	Description	Byte	Description
14	Number of input reference parameters (1)	40, 41	Ch1 Range: 0 span -10,000 to +10,000, units -10,000 to +10,000 1 span 0 to +10,000, units 0 to +10,000
15	Number of output reference parameters (2)	42, 43	Ch 1 Low Eng. Units (-32768 to +32767)
16, 17	Byte length of diagnostic discrete input data (0 - 3)	44, 45	Ch 1 High Eng. Units (-32768 to +32767)
18, 19	Memory type for the module's diagnostic input bits, usually type I. Enter one of the following numbers: 16 = I table 18 = Q table 10 = AI table 12 = AQ table	46, 47	Ch1 Low Span (-10,000 to +10,000 <=high)
20, 21	Relative offset from start of table	48, 49	Ch1 High Span (-10,000 to +10,000 >=low)
22, 23	Byte length of the module's analog output data (0 - 16)	50 - 59	Ch 2 parameters
24, 25	Memory type for the module's analog output data, usually type AQ. Enter one of the numbers listed above.	60 - 69	Ch 3 parameters
26, 27	Relative offset from start of table	70 - 79	Ch 4 parameters
28, 29	Byte length of module's control output bits (0 - 2)	80 - 89	Ch 5 parameters
30, 31	Memory type for the module's control output bits, usually type Q. Enter one of the numbers listed above.	90 - 99	Ch 6 parameters
32, 33	Relative offset from start of table.	100-109	Ch 7 parameters
34, 35	Local Default Output (0 = off, 1 = hold)	110-119	Ch 8 parameters
36, 37	BIU command timeout in milliseconds (500 to 65535)		
38, 39	Active Channels. One bit per channel. For each channel (0 = inactive, 1 = active). Default is 0xFF, all active.		

6.3.9.9. Additional Configuration Data for a Micro Field Processor Module

The content of configuration data bytes 14 to 43 for a Micro Field Processor module (IC670MFP100) is listed below.

See Subsection 6.3.9.1. for the content of bytes 0 to 13.

Byte	Description	Byte	Description
14	Number of input reference parameters (2)	28, 29	Byte length of the number of outputs from the BIU to the MFP's I table. (0 – 64)
15	Number of output reference parameters (2)	30, 31	BIU table to get data for the MFP's I table. Enter one of the numbers listed above.
16, 17	Byte length of number of inputs to BIU from the MFP's discrete output (Q) table (0 – 64)	32, 33	Byte offset of from the start of the selected BIU table to get data for the MFP's I table (0 – 255)
18, 19	BIU table to place Q data from the MFP. Enter one of the following numbers: 16 = I table 18 = Q table 10 = AI table 12 = AQ table	34, 35	Byte length of the number of outputs from the BIU to the MFP's AI table. (0 – 254)
		36, 37	BIU table to get data for the MFP's AI table. Enter one of the numbers listed above.
20, 21	Byte offset from the start of the selected BIU table to put MFP Q table data. (0 – 255)	38, 39	Byte offset of from the start of the selected BIU table to get data for the MFP's AI table (0 – 255)
22, 23	Byte length of the number of inputs to the BIU from the MFP's AQ table. (0 – 254)	40	Number of checksums. 0 means do not check program logic match. (0 – 255)
24, 25	BIU table to put AQ table from the MFP. Enter one of the numbers listed above.	41	Byte checksum of the MFP ladder logic.
26, 27	Byte offset from the start of the selected BIU table to put MFP AQ table data. (0 – 255)	42, 43	Word LRC checksum of MFP ladder logic.

6.4. Group Data Move Configuration Data Format

Bytes 0 to 11 must be: FF hex, 0,0,0,0,0,0,0,0,0,0

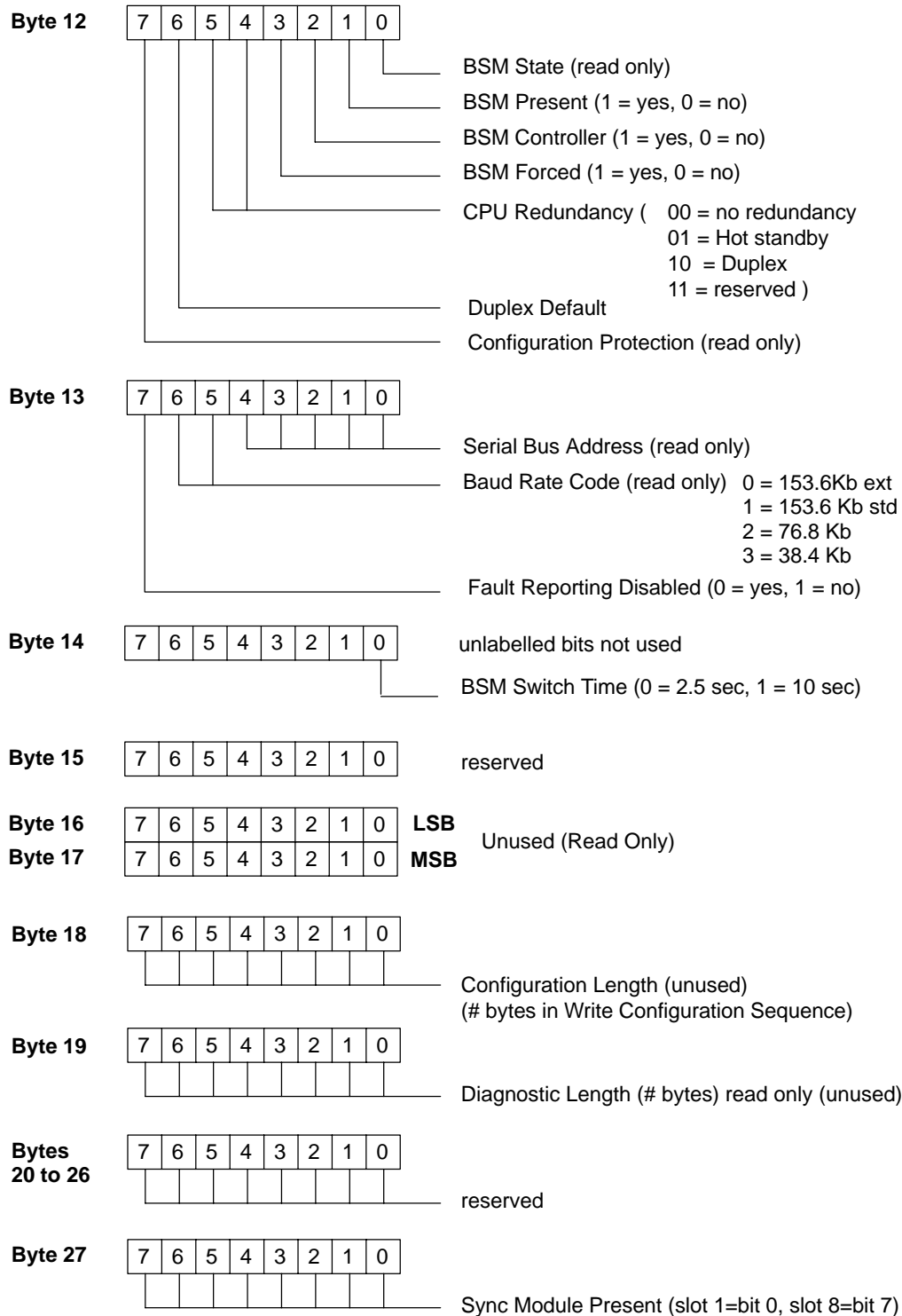

Group Move 1

The diagram below shows the sequence of group mode configuration data for Group Move 1, Move 1 and Move 2. The format for subsequent moves is the same.

Group Move 1

Byte 28	<table border="1"><tr><td>7</td><td>6</td><td>5</td><td>4</td><td>3</td><td>2</td><td>1</td><td>0</td></tr></table>	7	6	5	4	3	2	1	0	Source Slot
7	6	5	4	3	2	1	0			
Byte 29	<table border="1"><tr><td>7</td><td>6</td><td>5</td><td>4</td><td>3</td><td>2</td><td>1</td><td>0</td></tr></table>	7	6	5	4	3	2	1	0	Destination Slot
7	6	5	4	3	2	1	0			
Byte 30	<table border="1"><tr><td>7</td><td>6</td><td>5</td><td>4</td><td>3</td><td>2</td><td>1</td><td>0</td></tr></table>	7	6	5	4	3	2	1	0	Which Sweeps Data Group Will Be Moved
7	6	5	4	3	2	1	0			
Byte 31	<table border="1"><tr><td>7</td><td>6</td><td>5</td><td>4</td><td>3</td><td>2</td><td>1</td><td>0</td></tr></table>	7	6	5	4	3	2	1	0	Hold Last State/Default
7	6	5	4	3	2	1	0			

— Submove 1 —

Byte 32	<table border="1"><tr><td>7</td><td>6</td><td>5</td><td>4</td><td>3</td><td>2</td><td>1</td><td>0</td></tr></table>	7	6	5	4	3	2	1	0	Source Table Segment Selector
7	6	5	4	3	2	1	0			
Byte 93	<table border="1"><tr><td>7</td><td>6</td><td>5</td><td>4</td><td>3</td><td>2</td><td>1</td><td>0</td></tr></table>	7	6	5	4	3	2	1	0	Destination Table Segment Selector
7	6	5	4	3	2	1	0			
Byte 34	<table border="1"><tr><td>7</td><td>6</td><td>5</td><td>4</td><td>3</td><td>2</td><td>1</td><td>0</td></tr></table>	7	6	5	4	3	2	1	0	Source Offset in bytes, LSB
7	6	5	4	3	2	1	0			
Byte 35	<table border="1"><tr><td>7</td><td>6</td><td>5</td><td>4</td><td>3</td><td>2</td><td>1</td><td>0</td></tr></table>	7	6	5	4	3	2	1	0	Source Offset in bytes, MSB
7	6	5	4	3	2	1	0			
Byte 36	<table border="1"><tr><td>7</td><td>6</td><td>5</td><td>4</td><td>3</td><td>2</td><td>1</td><td>0</td></tr></table>	7	6	5	4	3	2	1	0	Destination Offset in bytes, LSB
7	6	5	4	3	2	1	0			
Byte 37	<table border="1"><tr><td>7</td><td>6</td><td>5</td><td>4</td><td>3</td><td>2</td><td>1</td><td>0</td></tr></table>	7	6	5	4	3	2	1	0	Destination Offset in bytes, MSB
7	6	5	4	3	2	1	0			
Byte 38	<table border="1"><tr><td>7</td><td>6</td><td>5</td><td>4</td><td>3</td><td>2</td><td>1</td><td>0</td></tr></table>	7	6	5	4	3	2	1	0	Byte Length of Data, LSB
7	6	5	4	3	2	1	0			
Byte 39	<table border="1"><tr><td>7</td><td>6</td><td>5</td><td>4</td><td>3</td><td>2</td><td>1</td><td>0</td></tr></table>	7	6	5	4	3	2	1	0	Byte Length of Data, MSB
7	6	5	4	3	2	1	0			

— Submove 2 —

Byte 40	<table border="1"><tr><td>7</td><td>6</td><td>5</td><td>4</td><td>3</td><td>2</td><td>1</td><td>0</td></tr></table>	7	6	5	4	3	2	1	0	Source Table Segment Selector
7	6	5	4	3	2	1	0			
Byte 41	<table border="1"><tr><td>7</td><td>6</td><td>5</td><td>4</td><td>3</td><td>2</td><td>1</td><td>0</td></tr></table>	7	6	5	4	3	2	1	0	Destination Table Segment Selectot
7	6	5	4	3	2	1	0			
Byte 42	<table border="1"><tr><td>7</td><td>6</td><td>5</td><td>4</td><td>3</td><td>2</td><td>1</td><td>0</td></tr></table>	7	6	5	4	3	2	1	0	Source Offset in bytes, LSB
7	6	5	4	3	2	1	0			
Byte 43	<table border="1"><tr><td>7</td><td>6</td><td>5</td><td>4</td><td>3</td><td>2</td><td>1</td><td>0</td></tr></table>	7	6	5	4	3	2	1	0	Source Offset in bytes, MSB
7	6	5	4	3	2	1	0			
Byte 44	<table border="1"><tr><td>7</td><td>6</td><td>5</td><td>4</td><td>3</td><td>2</td><td>1</td><td>0</td></tr></table>	7	6	5	4	3	2	1	0	Destination Offset in bytes, LSB
7	6	5	4	3	2	1	0			
Byte 45	<table border="1"><tr><td>7</td><td>6</td><td>5</td><td>4</td><td>3</td><td>2</td><td>1</td><td>0</td></tr></table>	7	6	5	4	3	2	1	0	Destination Offset in bytes, MSB
7	6	5	4	3	2	1	0			
Byte 46	<table border="1"><tr><td>7</td><td>6</td><td>5</td><td>4</td><td>3</td><td>2</td><td>1</td><td>0</td></tr></table>	7	6	5	4	3	2	1	0	Byte Length of Data, LSB
7	6	5	4	3	2	1	0			
Byte 47	<table border="1"><tr><td>7</td><td>6</td><td>5</td><td>4</td><td>3</td><td>2</td><td>1</td><td>0</td></tr></table>	7	6	5	4	3	2	1	0	Byte Length of Data, MSB
7	6	5	4	3	2	1	0			

The high byte of address + 2 of the pointer is not used; it must be zero. The low byte of address + 2 specifies the type of memory where the Status Pointer will be located.

For This Memory Type:		Enter This Number:
I	discrete input table	16
Q	discrete output table	18
R	register memory	8
AI	analog input table	10
AQ	analog output table	12

7. SET BUS INTERFACE UNIT OPERATING MODE

Subfunction Code: 39 hex

This datagram can be used to set the operating mode of the N80 Bus Interface Unit.

Byte No.	Byte Description
0	Mode
1	Mode

This message has two copies of the mode parameter. These copies must be equal for the command to be accepted by the Bus Interface Unit.

If you disable the network, the BIU sends no inputs and receives no outputs.

Bytes 0 and 1 (Must Match)

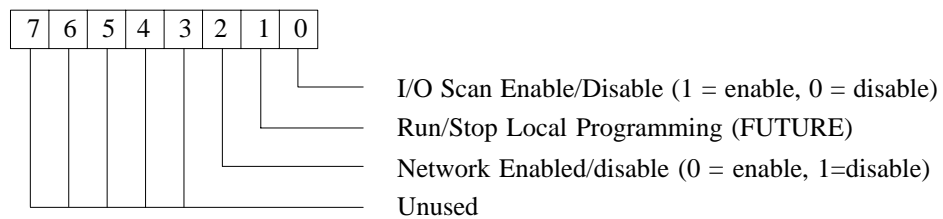

8. SET MICRO FIELD PROCESSOR OPERATING MODE

Subfunction Code: 21 hex

This datagram can be used to set the operating mode of a Micro Field Processor in the I/O Station.

Byte	Value	Description
0	F6 hex	Message code
1	18 hex	Command code
2	Slot No	The slot number of the Micro Field Processor
3	0	Reserved
4	0	Offset of the Least Significant Byte of the data
5	0	Offset of the Most Significant Byte of the data
6	4	Data length.
7	47 hex	
8	45 hex	
9	46 hex	
10	0	Code to set Micro Field Processor mode: 0 = Stop/No I/O Mode

9. INTELLIGENT ANALOG MODULE RECALIBRATION DATAGRAM

Subfunction Code: 21 hex

This datagram can be used to recalibrate a 16 Point Analog Grouped module (IC670ALG240), to restore the factory calibration, or to place the module into “warmup” mode for recalibration.

Byte	Value	Description
0	F6 hex	Message code
1	18 hex	Command code
2	Slot No	The module’s slot number
3	0	Reserved
4	0	Offset of the Least Significant Byte of the data
5	0	Offset of the Most Significant Byte of the data
6	length of data	Data length as shown in the following tables.
7–133	data	See below.

9.1. Message Content for Calibrating Low End of Channel

Byte	Value	Description
7	0	Reserved
8	Channel No	Channel to be calibrated (0 – 15)
9	0	Request to calibrate low end
10, 11		Current in microAmps. Recommended range is 3500 to 4500 microAmps.
12, 13	0–65535	Number of readings to average.
14 – 20	0	Reserved

9.2. Message Content for Calibrating High End of Channel

Byte	Value	Description
7	0	Reserved
8	Channel No	Channel to be calibrated (0 – 15)
9	1	Request to calibrate high end
10, 11		Current in microAmps. Recommended range is 19500 to 20500 microAmps.
12, 13	0–65535	Number of readings to average.
14 – 20	0	Reserved

9.3. Field Recalibration

The 16 Point Grouped Analog Input module is calibrated at the factory. It can also be recalibrated from the host, to adapt to different conditions. Calibration data consists of two sets of values for each channel. One value is provided to the module during calibration. The other value is a corresponding A/D sample value for that current that is determined by the module. One pair of values represents a low value (typically 4 mA) and the other represents a high value (typically 20 mA).

Recalibration, if needed, is done as described below.

5. Connect a known current to each of the channels.
6. (Optional) Place the module in warmup mode by sending the warm-up command from the host.
7. Send the calibration command from the host. The calibration command specifies the channel to calibrate and the current being supplied to the channel's input. There is a calibrate command for a high point and one for a low point.
8. The module samples the channel and calculates the nominal value using the default calibration data. The module reads the number of samples specified in the command (1 to 65535) and calculates the average. It then stores the current value and the sample average and recalculates the scaling constants for the channel.
9. The module returns status information about the recalibration to the BIU.

Message Content for Storing New Calibration to Field Area

Byte	Value	Description
7	0	Reserved
8	0	Reserved
9	3	Code to store to field area
10 – 20	0	Reserved

Message Content for Reverting to Factory Calibration

Byte	Value	Description
7	0	Reserved
8	0	Reserved
9	4	Code to revert to factory calibration
10 – 20	0	Reserved

Message Content for Putting Module in Warmup Mode

Byte	Value	Description
7	0	Reserved
8	0	Reserved
9	5	Code to put module in warmup mode
10 – 20	0	Reserved

10. READ I/O FORCES

Subfunction Code: 40 hex

This datagram can be used to set read force information from an N80 Bus Interface Unit. The information read is determined by the value specified in the datagram.

Byte No	Description
0	Force Table Requested: 0 = input enable 1 = output enable 2 = input values 3 = output values

- To read which inputs are forced, specify the number 0 in the datagram.
- To read which outputs are forced, specify 1 in the datagram.
- To read forced input values, specify 2 in the datagram.
- To read forced output values, specify 3 in the datagram.

In the BIU, two force enable tables show which points are forced. Two force values tables show the forced values. Each table contains a byte of data for each byte of discrete data followed by a word of data for each channel of analog data. For example, if a BIU is configured to have 6 bytes of discrete input data and 8 channels of analog input data, the input force enable table and input force value table would look like this:

Force Enabled Table

Byte No	Description
0	1st 8 discrete inputs force enable
1	2nd 8 discrete inputs force enable
2	.
3	.
4	.
5	last 8 discrete inputs force enable
6, 7	1st channel analog inputs force enable
8, 9	2nd channel analog inputs force enable
10, 11	.
12, 13	.
14, 15	.
16, 17	.
18, 19	8th channel analog inputs force enable

Force Values Table

Byte No	Description
0	1st 8 discrete inputs force values
1	2nd 8 discrete inputs force values
2	.
3	.
4	.
5	last 8 discrete inputs force values
6, 7	1st channel analog inputs force values
8, 9	2nd channel analog inputs force values
10, 11	.
12, 13	.
14, 15	.
16, 17	.
18, 19	8th channel analog inputs force value

Note that it is possible to have no discrete inputs or outputs or no analog inputs or outputs.

11. READ I/O FORCES REPLY

Subfunction Code: 41 hex

This datagram provides the information requested by a Read I/O Forces datagram.

Byte No	Description
0	Force Table Requested: 0 = input enable 1 = output enable 2 = input values 3 = output values
1 – 128	Input/Output force enable/value table data

For discrete data, a 1 in a bit position in the force enable table corresponds to an enabled force for that point. For analog data, the value FFFF (hex) in a word position in the enable table corresponds to an enabled force for an analog channel.

12. READ SLOT DIAGNOSTICS

Subfunction Code: 42 hex

This datagram can be used to read diagnostics information for a specific slot, point or channel from a BIU. This message does not provide channel or point information for intelligent modules (which includes certain types of I/O modules and Micro Field Processors). Intelligent modules can be configured to provide the information automatically.

Byte No	Description
0	Slot number: 1 – 8

Appendix *Scaling Analog Channels*

A

This appendix explains how to select scaling values when configuring an analog input or output. See chapter 5 for configuration instructions.

1. HOW SCALING WORKS

Analog modules convert between electrical signals (current or voltage) and digital values. These digital values are 0 to 4095 (for 12-bit converters). Digital values are often referred to as “counts”. They represent the data that is transferred between the Bus Interface Unit and an analog module.

To make the input or output data of conventional analog modules more meaningful to the application, the Bus Interface Unit performs a conversion process called scaling (note that the BIU performs scaling only for conventional analog modules; “intelligent” analog modules perform their own scaling). Scaling converts the module’s digital values to or from the engineering units values used by the application.

Typically, the engineering units represent millivolts or microamps. In other cases, they represent physical units such as degrees or centimeters per second. Since engineering units values are integers from -32767 to $+32767$, it is often necessary to use fractional units (such as hundredths of degrees) to preserve the resolution of a physical input or output.

Each channel of an analog module can be scaled independently. Scaling is configured by entering corresponding low and high engineering units values and low and high internal values for two points. The internal values represent millivolts or microamps.

The BIU uses the straight line defined by the two pairs of values to convert between engineering units and analog converter counts. The conversion takes into account the module type and the range that is selected.

2. SCALING VALUES FOR 1mV OR 1 μ A ENGINEERING UNITS

2.1. BIU Version 1.3

For many applications, the engineering units are either millivolts or microAmps. These units are easy to scale. Simply use the table below to find scaling values that are appropriate for the channel's configured range.

Analog Current Input Module

Range Selected	To measure this current	Enter this engineering units value		Internal Units (microAmps)	
4 to 20 mA	4 mA	Low	4000	Low	4000
	20 mA	High	+20000	High	+20000
0 to 20 mA	0 mA	Low	0	Low	0
	20 mA	High	+20000	High	+20000

Analog Current Output Module

Range Selected	To output this current	Enter this engineering units value		Internal Units (microAmps)	
4 to 20 mA	4 mA	Low	4000	Low	0
	20 mA	High	+20000	High	+20000
0 to 20 mA*	0 mA	Low	0	Low	0
	20 mA	High	+20000	High	+20000

Analog Current Source Output Module (IC670ALG320) in Voltage Mode

Range Selected	To output this voltage	Enter this engineering units value		Internal Units (microAmps)	
4 to 20mA	0 volts	Low	0	Low	0
	+10 volts	High	+10000	High	+20000
0 to 20 mA*	0 volts	Low	0	Low	0
	+12.5 volts	High	+12500	High	+20000

* Connect the output load between Volt (V) and Return (RET) for the channel being used. For 0 to +12.5 voltage, place a jumper between RET and JMP on the terminal block.

Horner Analog Voltage Input Module (HE670ADC810)

Range Selected	To measure this voltage	Enter this engineering units value		Internal Units (microAmps)	
0 to 10 volts	0 volts	Low	0	Low	0
	+10 volts	High	+10000	High	+10000
-10 to +10 volts	-10 volts	Low	-10000	Low	-10000
	+10 volts	High	+10000	High	+10000

2.2. BIU Version 2.0 or Later

For many applications, the engineering units are either millivolts or microAmps. These units are easy to scale. Simply use the table below to find scaling values that are appropriate for the channel's configured range.

Analog Current Input Module

Range Selected	To measure this current	Enter this engineering units value		Internal Units (microAmps)	
4 to 20 mA	4 mA	Low	+4000	Low	+4000
	20 mA	High	+20000	High	+20000
0 to 20 mA	0 mA	Low	0	Low	0
	20 mA	High	+20000	High	+20000

Analog Current Output Module

Range Selected	To output this current	Enter this engineering units value		Internal Units (microAmps)	
4 to 20 mA	4 mA	Low	+4000	Low	+4000
	20 mA	High	+20000	High	+20000
0 to 20 mA*	0 mA	Low	0	Low	0
	20 mA	High	+20000	High	+20000

Analog Current Source Output Module (IC670ALG320) in Voltage Mode

Range Selected	To output this voltage	Enter this engineering units value		Internal Units (microAmps)	
4 to 20mA	0 volts	Low	0	Low	+4000
	+10 volts	High	+10000	High	+20000
0 to 20 mA*	0 volts	Low	0	Low	0
	+12.5 volts	High	+12500	High	+20000

* Connect the output load between Volt (V) and Return (RET) for the channel being used. For 0 to +12.5 voltage, place a jumper between RET and JMP on the terminal block.

Horner Analog Voltage Input Module (HE670ADC810)

Range Selected	To measure this voltage	Enter this engineering units value		Internal Units (microAmps)	
0 to 10 volts	0 volts	Low	0	Low	0
	+10 volts	High	+10000	High	+10000
-10 to +10 volts	-10 volts	Low	-10000	Low	-10000
	+10 volts	High	+10000	High	+10000

3. MEASURING SCALING VALUES

If the circuit will not use mV/ μ A units, the most accurate scaling values can be found by taking actual measurements of the process. The process must be set to two distinctly different conditions, so two sets of measurements can be taken.

If the analog module is already installed, you can use it online to the process being measured, to obtain actual data values. By default, the Bus Interface Unit performs a 1 to 1 scaling on all channels. (Using the online method requires the prior configuration of at least the serial bus address, the I/O map and the module I/O references).

3.1. Finding the Digital Value with the Module Online to the Process

If the module is online to the process, follow the steps below to find the scaling values.

1. Set the process to the first condition to be measured.
2. Using a suitable external device, find the engineering units measurement (for example, PSI or degrees).
3. Read the corresponding value with the Hand-Held Monitor or the Alspa P8 software. The units (using the default scaling) are millivolts or microAmps.
 - a. using a Hand-Held Monitor in default mode, go to the Monitor screens (see chapter 7 Section 2. if you need further instructions) and read the channel's digital value.
 - b. using the Alspa P8 software, go to the appropriate data table and read the channel's digital value.
4. Set the process to the second condition to be measured and repeat steps 2 and 3 to find the second pair of scaling values.

3.2. Finding the Digital Value without the Module Online

If the module is not online to the process, you will need to take two measurements from the process and also measure the voltage or current associated with each. Convert this measurement to millivolts (for voltage) or microAmps (for current).

4. EXAMPLE OF SCALING AN ANALOG INPUT

A channel is configured in the 0 to 10 volts DC range. It measures a velocity input. Electronic sensors and mechanical linkage external to the block have determined that an input level of +1.5 volts DC is equal to -6 meters/second (-20 feet/second) and that +9 volts DC is equal to +55 meters/second (+180 feet/second). Plotting these values on a graph shows that a signal of 5 volts DC corresponds to a speed of 22 meters/second (73.3 feet/second).

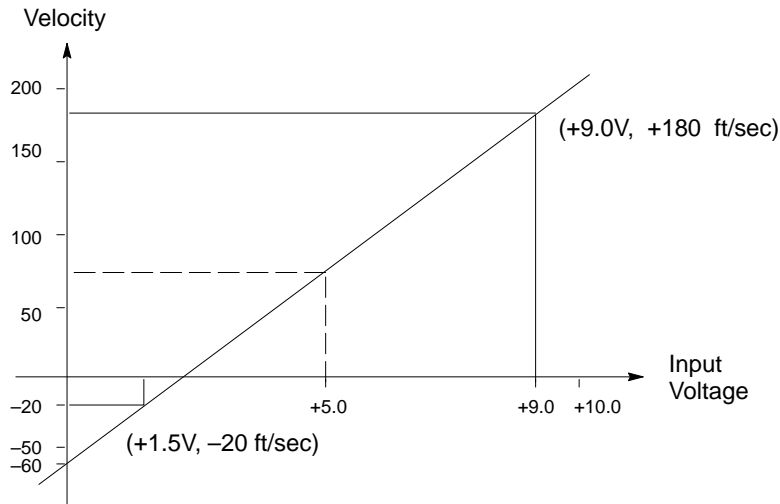

Figure A.1 – Scaling an analog input

For engineering units of feet per second, the following scaling values are used:

Low engineering units	=	-20	ft/sec
High engineering units	=	+180	ft/sec
Low internal units	=	1500	millivolts
High internal units	=	9000	millivolts

An input value of 5.0 volts would be scaled to an engineering value of +00073 (ft/sec).

In this example, scaling to hundredths of feet per second would provide better resolution. The following scaling values would be used:

Low engineering units	=	-2000	hundredths ft/sec
High engineering units	=	+1800	hundredths ft/sec
Low internal units	=	1500	millivolts
High internal units	=	9000	millivolts

An input value of 5.0 volts would be scaled to an engineering value of +7333 (hundredths ft/sec).

Appendix *Installing Additional Suppression*

B

This appendix describes some precautions that can be taken in an installation to help assure proper operation.

It is possible some installations might exceed the surge immunity capabilities specified in chapter 1. This is most likely in outdoor installations or where the power source is from another building or ground system. It is prudent to provide local transient protection.

Note

MOVs do a good job of absorbing transients on communications, control, and power lines, provided the total energy of those transients does not exceed the rating of the device.

However, if the energy of the transient exceeds the rating of the device, the MOV may be either damaged or destroyed. *This failure may not be visibly or electrically evident.* MOVs should be regularly inspected for signs of damage to assure continued protection against transients. For some applications, periodic replacement of critical MOVs is recommended, even if they do not show signs of damage.

1. SUPPRESSION AT THE POWER LINES

Protection can be provided by connecting higher-energy MOVs across the power lines (for instance, between Hot and Neutral) and from line to frame ground (safety ground). This triangular configuration requires three MOVs for each long power feed. If the total power feed length is about 30 meters (100 feet) or less, one set of MOVs should be enough for any number of devices. The MOVs used should be able to handle most line transients. Measurement of actual transients may be required in extreme cases to decide what MOVs to use.

2. SUPPRESSION FOR DEVICES IN AN ENCLOSURE

For a group of devices installed in an enclosure, the MOVs can be installed at the point where the power lines enter the enclosure. Ideally, MOVs should be used at each cabinet in the system for maximum protection. The following illustration shows suppression on both power lines and the communications bus for modules in an enclosure.

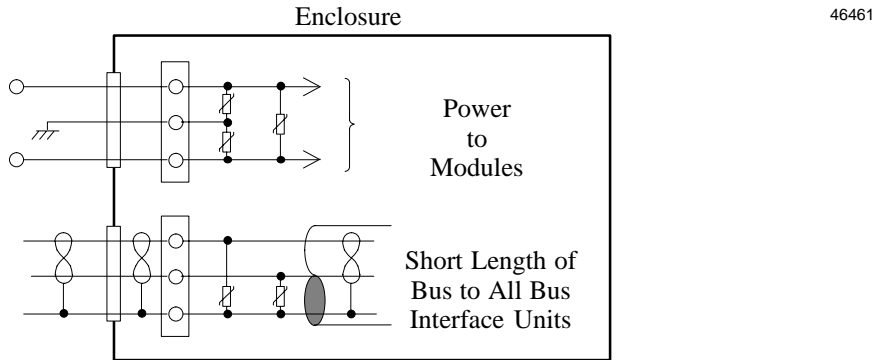

3. SUPPRESSION AT THE COMMUNICATIONS LINE

For an individual Bus Interface Unit, suppression can be supplied by connecting two small MOVs from Serial 1 and Serial 2 to the Bus Interface Unit's Shield Out terminal:

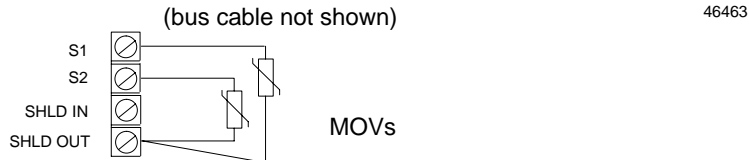

If necessary, higher energy rated devices can also be used. It is important to be sure that the MOV leads do not cause any shorts between the serial data and shield connectors.

Chapter 2 of the *ALS 52301 Alspa CE80-15 I/O System and Alspa N80 Communications Network User's Manual* describes the noise-rejection and filtering capabilities of the N80 network. It explains bus wiring practices for all applications. That chapter also gives additional instructions for installing a bus outdoors or between buildings, including recommendations for adding suppression at the point where the bus enters a building.

This appendix describes the selection and operating characteristics of the bus cable that links devices connected to the Alspa N80 network. This information supersedes the equivalent text portion of chapter 2 of the *ALS 52301 Alspa CE80–15 I/O System and Alspa N80 Communications Network User’s Manual* “The Communications Bus”.

An N80 serial bus consists of two or more N80 devices and (usually) the bus cable that connects them. A single block or bus controller with a Hand-Held Monitor directly attached, properly terminated with a 75Ω resistor, is considered the smallest possible Alspa N80 communications bus.

1. WIRING GUIDELINES

Four types of wiring may be encountered in a typical factory installation:

1. Power wiring – the plant power distribution and high power loads such as high horsepower motors. These circuits may be rated from tens to thousands of kVA at 220 VAC or higher.
2. Control wiring – usually either low voltage DC or 120 VAC of limited energy rating. Examples are wiring to start/stop switches, contactor coils, and machine limit switches. This is generally the interface level of the discrete I/O.
3. Analog wiring – transducer outputs and analog control voltages. This is the interface level to Alspa CE80–15 I/O analog blocks.
4. Communications and signal wiring – the communications network that ties everything together, including computer LANs, MAP and Alspa N80 I/O and communications bus.

These four types of wiring should be separated as much as possible to reduce the hazards from insulation failure, miswiring and interaction (noise) between signals. A typical PLC system with Alspa N80 I/O may require some mixing of the latter three types of wiring, particularly in cramped areas inside motor control centers and on control panels. In general, it is acceptable to mix the N80 bus cable with the I/O wiring from the blocks, as well as associated control level wiring. All noise pickup is cumulative, depending on both the spacing between wires and the distance span they run together. I/O wires and N80 bus cable can be placed randomly in a wiring trough for lengths of up to 15 m (50 feet). If wiring is cord-tied (harnessed), do not include the bus cable in the harness, since binding wires tightly together increases the coupling and mechanical stress that can damage the relatively soft insulation of some serial cable types.

Wiring external to equipment, and in cable trays, should be separated following, for example, standard American NEC practices. The pickup over long-distance runs with adequate spacing consists of common mode and ground voltage differences. These are rejected due to the differential transmission mode of the N80 bus and the bus isolation transformers built into each Alspa CE80–15 I/O block.

2. ELECTRICAL INTERFACE

The N80 serial bus uses computer grade twisted pair data cable. The half duplex token sequence used requires only a single pair since at any time only one station is transmitting and all others are receiving. All stations must receive in order to track the present token value and take their appropriate turn on the bus, regardless whether the data is to be used locally. The transmit sequence is the same as the serial bus address (SBA) set into each location during configuration. A simplified interface circuit is shown below:

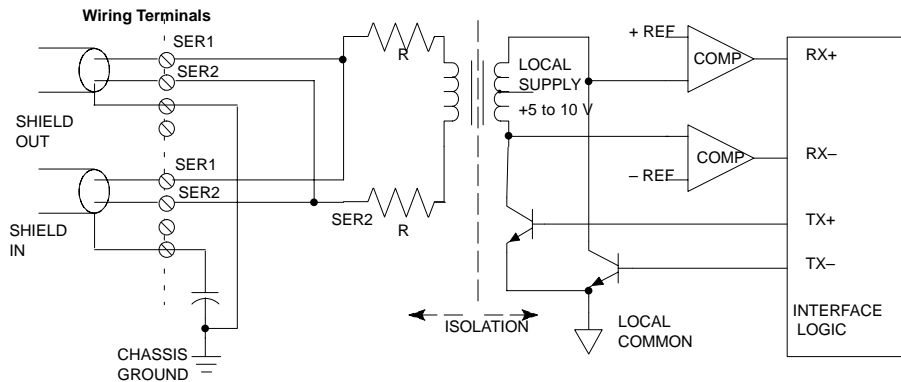

Signal coupling to the bus is via a high frequency, high isolation pulse transformer. This permits the bus and the local logic to be at different voltage levels. The pulse waveforms are bipolar (see next section below) to reduce DC baseline offsets in the waveform.

The daisy-chained bus is shown on the left in the above illustration. The SER 1 and SER 2 lines are merely tapped at the intermediate locations along the bus. These connections must be consistent since the signal is polarized. The shield of the cable is broken into segments at each location. Each shield segment is DC grounded at one end (SHIELD OUT) and terminated with a small capacitor at the other (SHIELD IN). The segmenting breaks up long ground loop paths. The capacitor termination reduces common mode noise from high frequency pickup, while preventing large ground loop currents in the shield at low frequencies.

The alternately switching transistors produce a negative pulse followed by a positive pulse across **SERIAL 1** relative to **SERIAL 2**. The bit waveform is a series of these pulses, as will be shown later. The transformer provides isolation (2500 volts test) between the bus and the local logic, permitting these to be at different voltages. The internal resistors in each line provide current limit and some termination function during transmission.

The balanced (differential) signals on the twisted pair provide high noise immunity due to the magnetic (H field) cancellation effect of the twisting, as well as electric (E field) reduction by the shielding. Most remaining noise pickup is common mode: the transformer provides a high common mode noise rejection by looking only at the differential signal across the SER 1-2 lines. The two input comparators detect the positive polarity input pulses separately from the negative; these are sent to a custom interface logic chip which digitally filters these for timing and sequence, then reconstructs the NRZ digital data. Voltages between the two thresholds are ignored. This filtering and the high input threshold of the comparators, are highly effective in rejecting both random impulse noise and low level line reflections. Finally a CRC-6 checksum check is performed before the data is sent to the local processor (not shown).

N80 Transceiver Electrical Specification

Property	Min	Max
Normal peak voltage Vp into 78 ohm terminated cable (1)	3.5 volts	5.5 volts
Normal peak voltage Vp into 150 ohm terminated cable (1)	6.0 volts	9.5 volts
Rated bus impedance (2)	78 ohms	150 ohms
Maximum output voltage (SER 1 and 2 open) (3)	Peak RMS	35 volts 15 volts
Maximum output current (SER 1 and 2 shorted together)	Peak RMS	180 milliamp 50 milliamp
Transmitter source resistance	80 ohms	140 ohms
Transmitter source inductance (transformer leakage inductance)		10 microhenrys
Receiver input threshold; +Vr, -Vr (4)	0.7 volt	1.1 volt
Receive mode input impedance	10 K ohm	
Receive mode load inductance (transformer shunt inductance)	6 millihenrys	12 millihenrys
Receiver common mode rejection (DC to 1 MHz)	60 dB	
Shield capacitor termination	0.1 microfarad	
Isolation, serial bus to circuit, continuous	240 volts AC	

- (1) Vp may vary among various module types.
(2) Rated load is half cable impedance when termination is included.
(3) Peak open circuit voltage contains underdamped ringing due to lack of termination.
(4) Input voltages between +Vr and -Vr thresholds are ignored.

3. SELECTING A CABLE TYPE

The N80 bus is a shielded twisted-pair wire, daisy-chained from block to block and terminated at both ends. Proper cable selection is critical to successful operation of the system.

Each bus in the system can be any cable type listed in the table below. Do not mix cables of different impedance, regardless of cable run length. Do not mix cable types in long and/or noisy installations. Other, small-size twisted pair shielded wire of unspecified impedance can be used for short runs of 15 m (50 feet) or less, using 75 ohm terminations. Selection of wire type may be limited by local and national codes and industry standards. Consult the cable manufacturer to determine the cable's suitability for a particular type of installation.

Conservative wiring practices and national and local codes require physical separation between control circuits and power distribution or motor power. Refer to sections 430 and 725 of the U.S. National Electric Code.

Cable No & Make	NEC (USA) Type	Outer Diameter	Terminating Resistor* -10%to+20% 1/2 Watt	Number of Conductors/ AWG	Dielectric Voltage Rating	Ambient Temp Rating	Maximum Length Cable Run, feet/meters at baud rate			
							153.6s	153.6e	76.8	38.4 ●
(A)9823 (C)4596 (M)M39240	none CL2 CM	0.350in 8.89mm	150 ohms	2 / No22	30 V	60 °C	2000ft 606m	3500ft 1061m	4500ft 1364m	7500ft 2283m
(B)89182	CL2P	0.322in 8.18mm	150 ohms	2 / No22	150 V	200 °C	2000ft 606m	3500ft 1061m	4500ft 1364m	7500ft 2283m
(B)9841 (M)M3993	CM CL2	0.270in 6.86mm	120 ohms	2 / No24	30 V	80 °C	1000ft 303m	1500ft 455m	2500ft 758m	3500ft 1061m
(A)9818C (B)9207 (M)M4270	CL2 CM CM	0.330in 8.38mm	100 ohms	2 / No20	300 V	80 °C	1500ft 455m	2500ft 758m	3500ft 1061m	6000ft 1818m
(A)9109 (B)89207 (C)4798 (M)M44270	CL2P CM * CMP	0.282in 7.16mm	100 ohms	2 / No20	150 V	200 °C	1500ft 455m	2500ft 758m	3500ft 1061m	6000ft 1818m
(A)9818D (B)9815	none *	0.330in 8.38mm	100 ohms	2 / No20			1500ft 455m	2500ft 758m	3500ft 1061m	6000ft 1818m
(O)911264	none	0.260in 6.60 mm	100 ohms	1 / No22	250 V	80 °C	1500ft 455m	2000ft 606m	3000ft 909m	4500ft 1364m
(E)532185 BBDN **	CM	approx 0.50in (12.7mm)	100 ohms	4 pairs No24 (solid)	>150 V	80 °C	1500ft 455m	2000ft 606m	3000ft 909m	4500ft 1364m
(A)9818 (B)9855 (M)M4230	* CM CM	0.315in 8.00mm	100 ohms	4 (two pair) No22	150 V	60 °C	1200ft 364m	1700ft 516m	3000ft 909m	4500ft 1364m
(A)9110 (B)89696 (B)89855	none CMP CMP	0.274in 6.96mm	100 ohms	4 (two pair) No22	150 V	200 °C	1200ft 364m	1700ft 516m	3000ft 909m	4500ft 1364m
(A)9814C (B)9463 (M)M4154	none CM CL2	0.243in 6.17mm	75 ohms	2 / No20	150 V	60 °C	800ft 242m	1500ft 455m	2500ft 758m	3500ft 1061m
(A)5902C (B)9302 (M)M17002	none CM CM	0.244in 6.20mm	75 ohms	4 (two pair) No22	300 V	80 °C	200ft 60m	500ft 152m	1200ft 333m	2500ft 758m

A = Alpha, B = Belden, C = Consolidated, E = Essex, M = Manhattan, O = Oilflex

● = Limited to 16 taps at 38.4 Kbaud

* = not known

** = Suitable for applications requiring high flexibility, continuous flex or vibration.

NEC classes are based on data obtained from manufacturers and are subject to change. CANADIAN CEC codes are generally similar. Other countries may vary. The serial bus can be treated as a Class 2 circuit when appropriate wiring practices are followed. Maximum available bus lengths may be affected when installation requires the high voltage rated CM (Communications) rating. CM types can replace CL2, but not vice versa.

4. SERIAL BUS WAVEFORMS

The actual waveforms seen on the cable depend on the cable impedance and the distance from the station presently transmitting. A data “0” is a series of three AC pulses, while a “1” is no pulse.

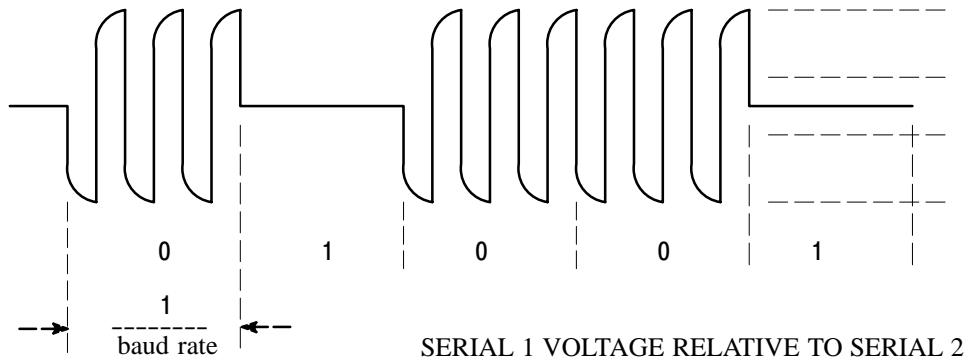

Use caution when connecting instrumentation to the bus. A differential probe or a summation of two probes relative to ground is required. Inadvertent grounding of one side of the bus can cause loss of data or data errors.

The pulse frequency is three times the baud frequency, for example 460.8 KHz at 153.6 Kb.

The peak transmitted voltage V_p and the receiver thresholds V_r are per the electrical specification above. The peak voltages measured will decline with distance along the cable from the transmitting station, so different stations will have varying amplitudes. The wave shape will also become more rounded with distance.

The minimum amplitude pulses seen during a “0” should exceed the receiver threshold V_r of 900 millivolts by 50% (about 1.4 volts) for best reliability. An occasional pulse at or below the threshold may still not cause the bit to be missed, due to a voting algorithm in the logic, however.

Likewise, no pulses greater than V_r should exist during logic “1” intervals. Occasional extra pulses during this interval are also rejected by the logic.

Line reflections will show up as notch distortion during the pulse or low level pulses during “1” intervals, and their appearance is synchronized to the baud frequency. These cause no problem if they do not cause violation of the amplitude criteria of the previous paragraphs.

The Serial 1 and Serial 2 lines should always have a termination resistor equal to the characteristic impedance of the cable connected at each extreme end. When testing an Alspa CE80–15 block or other device using a Hand Held Monitor, when no serial bus is present, a terminating resistor will improve integrity (75 Ohms) is recommended.

5. USING OTHER CABLE TYPES

The cable types listed in the preceding table are recommended for use. If the cable types listed above are not available, the cable selected must meet the following guidelines.

1. High quality construction. Most important is uniformity of cross section along the length of the cable. Poor quality cable may cause signal distortion and increase the possibility of damage during installation.
2. Precision-twisted shielded wire of EIA RS422 standard type, having a uniform number of twists per unit of length. In a catalog, this type of cable may also be listed as twinaxial cable, data cable or computer cable.
3. Relatively high characteristic impedance; 100 to 150 ohms is best; 75 ohms is the minimum recommended.
4. Low capacitance between wires, typically less than 60pF/meter (20pF/foot). This may be accomplished by inner dielectrics of foamed type, usually polypropylene or polyethylene, having a low dielectric constant. Alternatively, the conductors may be spaced relatively far apart. Lower impedance types have smaller cross-sections and provide easier wiring for shorter total transmission distances.
5. Shield coverage of 95% or more. Solid foil with an overlapped folded seam and drain wire is best. Braided copper is less desirable; spiral wound foil is least desirable.
6. An outer jacket that provides appropriate protection, such as water, oil or chemical resistance. While PVC materials can be used in many installations, Teflon, polyethelene or polypropylene are usually more durable.
7. Electrical characteristics: cable manufacturers' information about pulse rise time and NRZ data rate is useful for comparing cable types. The N80 bit consists of three AC pulses; the equivalent NRZ bit rate is about three times as great.

For assistance in selecting a specific cable type, please consult your local ALSTOM engineer.

6. PREFABRICATED CABLES

For applications using 150 ohm cables, prefabricated cables are available in 15" (IC660BLC001) and 36" (IC660BLC003) lengths. These cables terminate in mating connectors that simplify wiring between I/O blocks. The 36" cable is recommended for Alspa CE80–20 installations.

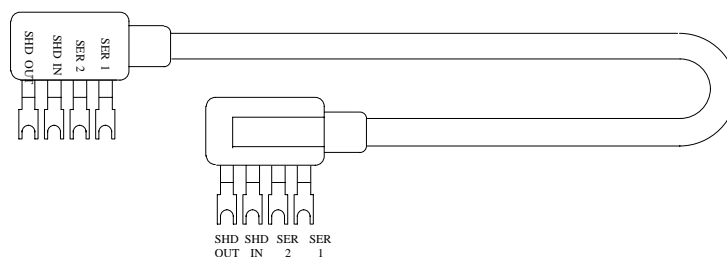

7. EFFECT OF LONG CABLES, REPEATERS OR UNSPECIFIED CABLE TYPES ON MAXIMUM LENGTH BUS

Three effects limit the maximum length bus available at any baud rate:

1. Voltage attenuation,
2. Waveform distortion (frequency dispersion),
3. Propagation delays.

7.1. Attenuation

The transmitter output levels and receiver thresholds determine the maximum attenuation that can be tolerated. For Alspa N80 (remote I/O) products, this is the principal determinant when using recommended cable types.

7.2. Distortion

Waveform distortion is due to the limited bandwidth of wire media, which causes the various frequency components of a pulse waveform to travel at different speeds and thus arrive separately in time (called dispersion). As a result, the received pulse appears rounded and distorted. The signal at the extreme end from the transmitter may look rounded and skewed as shown below. Distortion is most apparent near the beginning and end of a pulse train where it may appear as a change in phase or a frequency shift. Critical timing for a logic 0 transmission is shown below in a more detailed version of the waveform:

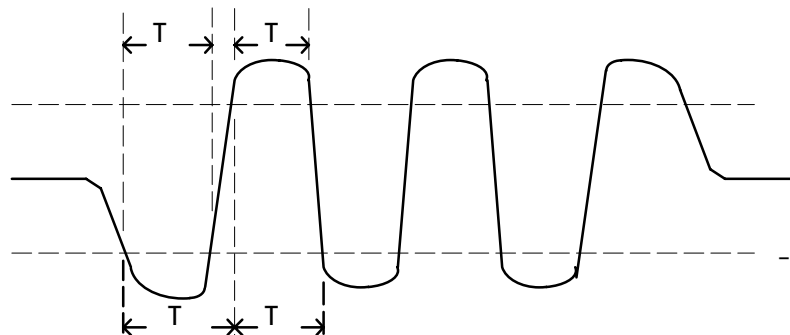

Note the first and last half-cycle look wider. The most critical to operation is the first full cycle of the first start bit of the transmission. Detection of this pulse establishes the time synchronization of the receiver to the incoming waveform. Missing this first pulse does not cause the data to be missed, but may compromise the noise immunity with respect to extra or missing pulses. The frequency of the AC pulse is 3X the baud rate as noted earlier. This means the normal period $T_p(\text{normal})$ is:

- 2.17 microseconds at 153.6 Kb,
- 4.34 microseconds at 76.8 Kb,
- 8.68 microseconds at 38.4 Kb.

The half cycle pulse width, when measured between the positive and negative receiver thresholds, denoted as $T_{p/2}$ in the figure, will vary along the waveform due to dispersion and resembles a frequency shift. The digital input filter essentially is a band pass filter which looks at the half cycle timing $T_{p/2}$ and the duration above the thresholds, T_w . The limits are:

- $T_{p/2} = 0.6 T_{p(\text{normal})}$ maximum,
- $T_w = 0.188 T_{p(\text{normal})}$ minimum.

These measurements can be taken when evaluating the maximum length of an unspecified cable. Dispersion is much less of a problem with fiber optic links since the media is much wider bandwidth and therefore has less distortion.

7.3. Propagation Delay

The propagation delay is caused by travel time of the signal down the cable. Typical signal velocity in data grade cables is around 65– 78% of the speed of light. This requires about 3 microseconds to travel a 600 meters (2000 foot) long bus. This is about half a bit time at 153,6 Kb. This skew could affect the bus access sequence since only one bit of quiet bus (skip) time is usually allocated between transmission of adjacent addresses. (Refer to Bus Access Time § 9.) The signal must reach all devices on the bus within the period of one bit. Propagation delay causes the ultimate limitation in bus length, even with ideal media. Propagation speed through fiber optic is not significantly different than wire and delays through the interfaces must be accounted for.

8. SERIAL DATA FORMAT

The N80 protocol is designed to produce maximum throughput of data by using a minimum overhead of control and synchronizing characters.

Each character is 11 bits long, comprising a start bit (always 0), next a control bit, followed by 8 bits of data, sent LSB first. The last bit is a stop bit, always 1. Successive characters are sent with no time space between them. The control bit is used to signal the type of character being sent. A 1 indicates a control character and 0 a data character.

A minimum transmission is comprised of a start character, one or more data characters and a stop character. The Start character data contains the address and whether the transmission is directed to a specific address or a broadcast to all. The End character contains the CRC-6 checksum. More complex transmissions may have additional start and end of block characters to break up the message into “blocks” of data (not to be confused with Alspa CE80-15 I/O “Blocks”). For example, a Bus Controller can send device specific messages (blocks of data) to all devices on the bus during one transmission cycle.

9. BUS ACCESS

All devices must receive the current SBA and the stop character even though the data is irrelevant locally. After the stop control character is received, each device on the bus starts a timer. The time delay is equal to a “skip time”, times the difference between the device Serial Bus Address (SBA) and the last SBA received. The device will transmit after the time delay if no other start bits are detected first. Thus each device takes turn in order of SBA. Unused SBAs result in longer times between messages. All devices must detect messages within this skip time delay. A bus “collision” (two sources transmitting simultaneously) results if this sequence is missed. The skip time value is equal to one bit period, except on the 153.6 extended rate, where it is two bit periods long. The longer interval is useful to accommodate the longer propagation delays due to longer bus cables or when delays are introduced by fiber optic or other repeaters, The worse case is when adjacent SBAs are physically located at opposite ends of a long bus. For example, assume SBA 4 and 6 are at one end of a 600 meters (2000 foot) bus and SBA5 at the other, operating at 153.6 standard Kb. When SBA 4 end character is detected, SBA6 immediately starts timing 2 skip times (13 μ sec) to start of it’s transmission. SBA5 receives the end character 3 μ sec later and starts timing 1 skip time (6.5 μ sec). Thus SBA 5 will start transmitting 9.5 μ sec after SBA 4 quit. This allows 3.5 μ sec for the signal to get back to SBA6 to cancel it’s transmission turn. The 3 μ sec transmission delay leaves only 0.5 μ sec to do this and avoid a collision between SBA5 and 6.

Bus collisions result in missing data or detected CRC errors. Problems resulting from bus collisions can be fixed by not using (skipping) a SBA, resequencing SBAs in order along the bus, going from 153.6 standard baud to the 153.6 extended or a lower baud rate.

10. BUS LENGTH

The maximum bus length for shielded, twisted-pair cable is 2250 meters (7500 feet). Some cable types are restricted to shorter bus lengths. In turn, the bus length determines which baud rate may be selected.

If the application requires greater bus length, fiber optics cable and modems can be used, as explained later in this chapter.

11. BAUD RATE SELECTION

An Alspa CE80–15 I/O or communications bus can operate at one of four baud rates:
153.6 Kbaud standard, 153.6 Kbaud extended, 76.8 Kbaud, or 38.4 Kbaud.

Follow these guidelines when selecting the baud rate for a bus:

1. All devices on a bus must operate at the same baud rate (other busses in the system may operate at different baud rates).
2. If the cable length is between 1350 and 2250 meters (4500 and 7500 feet), you must select 38.4 Kbaud. This data rate only supports a maximum of 16 device on the bus.
3. If the cable length is between 1050 and 1350 meters (3500 and 4500 feet), select 76.8 Kbaud.
4. If cable length is between 600 and 1050 meters (2000 and 3500 feet), select 153.6 Kbaud extended.
5. If the cable length is less than 600 meters (2000 feet), either 153.6 Kbaud standard or 153.6 Kbaud extended can be used. The products are set to operate at 153.6 Kbaud standard when shipped from the factory. The use of 153.6 Kbaud extended is recommended, especially if the system will include a dual bus with Bus Switching Modules.

In noisy environments, 153.6 Kbaud extended provides improved noise immunity with little effect on bus scan time. If a system is experiencing excessive blinking of the bus controller's COMM OK light or if the I/O blocks' I/O Enabled LEDs go off frequently, 153.6 Kbaud extended should be used.

The baud rate selected should be indicated on all blocks, especially if different busses in the facility use different baud rates. Before connecting a Hand-Held Monitor to a functioning bus, check that it has been configured to the correct baud rate. If not, change the HHM baud rate selection, turn off the HHM, connect it to the bus, then turn the HHM on.

12. BUS AMBIENT ELECTRICAL INFORMATION

12.1. General

Most capacitively- and magnetically-coupled noise shows up as common mode voltage on the bus. The bus provides a 60 dB common mode rejection ratio. A noise spike above 1000 volts would be required to corrupt the data. The bus receivers filter out corrupted data and perform a 6-bit cyclic redundancy check to reject bad data. Corrupted signals due to noise show up as missed data rather than incorrect data. The bus continues operating to the maximum extent possible when bus errors are detected; random bus errors do not shut down communications. Bad data is rejected by the receiving device and excessive errors are reported to the controller. Bus errors are indicated by flickering of I/O block and bus controller LEDs. If excessive bus errors occur, the problem should be found and corrected.

12.2. Lightning Transient Suppression

Running the bus cable outdoors or between buildings may subject it to lightning transients beyond the 1,500 volt transient rating of the system. Installing cable underground reduces the probability of a direct lightning strike. However, buried cables can pick up hundreds of amperes of current when lightning contacts the ground nearby.

Therefore, it is important to protect the installation by including surge protectors on underground data lines. The cable shields should be grounded directly. Surge suppressors and spark gaps should be used to limit the voltage that might appear on the signal lines. It is recommended to install two (only) silicon surge suppressors or spark gaps to control transients of 1 to 25 Kilovolts from 100 to 1000 amps or more. These devices should be installed close to the entrance of the bus to the outdoors.

Silicon Surge Suppressors are available from many sources, including Clare/General Instruments and Motorola. Spark gaps are available from Clare. Refer to the vendor's literature for installation details.

In extreme situations, such as totally-isolated power systems, additional protection against lightning damage should be provided by adding surge suppressors for groups of I/O blocks. Such suppressors should be installed from incoming power leads to ground (enclosure baseplate/block case where leads enter the enclosure).

A device specifically designed to protect the N80 bus is available from the U.S. company, CONTROL TECHNOLOGY. Contact them or ALSTOM for application information. The device must be used in combination with power line suppression to fully protect the system.

Appendix *Configuration Examples*

D

This appendix includes examples of different Alspa CE80–20 I/O Station configurations:

- An I/O Station with discrete data only, where all of the data is configured within the BIU's I/O map. The BIU sends all inputs from Alspa CE80–20 modules on the network. All outputs are generated by the system controller (for example, a PLC) which sends them to the BIU over the network.
- An I/O Station with both analog and discrete data, where all of the data is configured within the BIU's I/O map. As in the first example, the BIU sends all inputs from Alspa CE80–20 modules on the network. All outputs are generated by the system controller that sends them to the BIU over the network.
- An I/O station with both discrete and analog data, which also includes a Micro Field Processor. The Micro Field Processor performs some I/O processing locally.
- An I/O Station with both discrete and analog data, which also includes a Micro Field Processor. Group Data Moves are used to transfer data within the I/O Station. This configuration allows all station inputs to be solved by the Micro Field Processor and all station outputs to be controlled by the Micro Field Processor. The system controller (for example, a PLC) will receive all station inputs. If the Micro Field Processor stops providing outputs, the system controller will assume control of all station outputs.

Example 1: Discrete Data, Network Processing

In this I/O Station, there are only discrete I/O modules. All data is included within the I/O map that is configured for the Bus Interface Module and exchanged over the network. There is no local Micro Field Processor.

BIU Map: I00001 – I00016
 Q00001 – Q00024

No synchronization is required.

Slot 1:	12VDC 16-Point Pos/Neg Input Module (IC670MDL640)	I00001 – I00016
Slot 2:	5/12/24VDC 16-Point Output Module (IC670MDL742)	Q00001 – Q00016
Slot 3:	8-Point Relay Output Module (IC670MDL930)	Q00017 – Q00024

Example 2: Discrete and Analog Data, Network Processing

In this I/O Station, there are both discrete and analog I/O modules. All data is included within the I/O map that is configured for the Bus Interface Module and exchanged over the network. There is no local Micro Field Processor.

BIU Map: I00001 – I00104
 Q00001 – Q00040
 AI00001 – AI00024
 AQ00001 – AQ00004

No synchronization is required.

Slot 1:	12VDC	16-Point	Pos/Neg	Input	Module	I00001 – I00016 (IC670MDL640)
Slot 2:	5/12/24VDC	16-Point		Output	Module	Q00001 – Q00016 (IC670MDL742)
Slot 3:	8-Point Relay Output Module (IC670MDL930)					Q00017 – Q00024
Slot 4:	8-Channel Analog Input Module (IC670ALG230)					AI00001 – AI00008
Slot 5:	High-level 16-Channel Analog Input Module (IC670ALG240):					
	analog inputs:					AI00009 – AI00024
	diagnostic inputs:					I00017 – I00104
	control outputs:					Q00025 – Q00040
Slot 6:	4-Channel	Analog		Output	Module	AQ00001 – AQ00004 (IC670ALG320)

Example 3: Discrete and Analog Data, Network and Local Processing

In this I/O Station, there are discrete and analog I/O modules and a Micro Field Processor. All inputs are given to the Micro Field Processor and processed. All outputs solved by the Micro Field Processor drive the station outputs.

All inputs from the station are sent back the the system controller as well. The system controller sends outputs to all modules but as long as the Micro Field Processor is present, system outputs are not used by the modules. If the local Micro Field Processor should stop providing outputs, the outputs received from the system controller will be used as station outputs.

BIU Map: I00001 – I00104
 Q00001 – Q00040
 AI00001 – AI00024
 AQ00001 – AQ00004

Slot 1 synchronization is required.

Slot 1:	Micro Field Processor (IC670MFP100)				
	Map BIU I00001–00104 to MFP I00001 – 00104, so all inputs on station become inputs to MFP				
	Map BIU AI00001–00024 to MFP AI00001 – 00024, so all inputs on station become inputs to MFP				
	Map BIU Q00001–00040 to MFP Q00001 – 00040, so all outputs from MFP control station outputs				
	Map BIU AQ00001–00004 to MFP AQ00001 – 00004, so all outputs from MFP control station outputs				
	Set all MFP default parameters to No (Hold Last State)				
Slot 2:	12VDC	16-Point	Pos/Neg	Input	Module I00001 – I00016 (IC670MDL640)
Slot 3:	5/12/24VDC	16-Point		Output	Module Q00001 – Q00016 (IC670MDL742)
Slot 4:	8-Point Relay Output Module (IC670MDL930)				Q00017 – Q00024
Slot 5:	8-Channel Analog Input Module (IC670ALG230)				AI00001 – AI00008
Slot 6:	High-level 16-Channel Analog Input Module (IC670ALG240):				
	analog inputs:				AI00009 – AI00024
	diagnostic inputs:				I00017 – I00104
	control outputs:				Q00025 – Q00040
Slot 7:	4-Channel	Analog		Output	Module AQ00001 – AQ00004 (IC670ALG320)

Example 4: Discrete and Analog Data, Network and Local Processing and Group Data Moves

In this I/O Station, there are discrete and analog I/O modules and a Micro Field Processor. Group Data Moves are used to transfer data within the I/O Station. This configuration allows all station inputs to be solved by the Micro Field Processor and all station outputs to be controlled by the Micro Field Processor. The system controller (for example, a PLC) will receive all station inputs. If the Micro Field Processor stops providing outputs, the system controller will assume control of all station outputs.

BIU Map: I00001 – I00168
 Q00001 – Q00056
 AI00001 – AI00028
 AQ00000 – AQ00000 (zero length)

Slot 1 synchronization is required.

Slot 1:	Micro Field Processor (IC670MFP100)	Reference parameters zero length
Slot 2:	High-level 16-Channel Analog Input Module (IC670ALG240)	Reference parameters zero length
Slot 3:	4-Channel RTD Input Module (IC670ALG620)	Reference parameters zero length
Slot 4:	8-Channel Thermocouple Input Module (IC670ALG630)	Reference parameters zero length
Slot 5:	16-Point 12–120 VAC Output Module (IC670MDL330)	Q00041 – 00056

Group Move No 1: Source slot 2, Destination slot 0 (move inputs from High-level Analog Input module to BIU input tables). All submoves can be set to default to either Yes or No.

- Submove 1:** (Moves diagnostic bits)
 Source reference I00001
 Destination reference I00001
 Length 11 bytes
- Submove 2:** (moves analog inputs)
 Source reference AI00001
 Destination reference AI00001
 Length 32 bytes

Group Move No 2: Source slot 0, Destination slot 2 (move outputs from BIU tables to High-level Analog Input module control outputs).

- Submove 1:** Source reference Q00001
 Destination reference Q00001
 Length 2 bytes

Group Move No 3: Source slot 3, Destination slot 0 (move RTD inputs to BIU input tables). All submoves can be set to default to either Yes or No.

- Submove 1:** (Moves diagnostic bits)
Source reference I00001
Destination reference I00089
Length 4 bytes
- Submove 2:** (moves analog inputs)
Source reference AI00001
Destination reference AI00017
Length 8 bytes

Group Move No 4: Source slot 0, Destination slot 3 (move control outputs from BIU tables to RTD module).

- Submove 1:** Source reference Q00017
Destination reference Q00001
Length 1 byte

Group Move No 5: Source slot 4, Destination slot 0 (move Thermocouple inputs to BIU input tables). All submoves can be set to default to either Yes or No.

- Submove 1:** (Moves diagnostic bits)
Source reference I00001
Destination reference I00121
Length 6 bytes
- Submove 2:** (moves analog inputs)
Source reference AI00001
Destination reference AI00021
Length 16 bytes

Group Move No 6: Source slot 0, Destination slot 4 (move control outputs from BIU tables to Thermocouple module).

- Submove 1:** Source reference Q00025
Destination reference Q00001
Length 2 bytes

Group Move No 7: Source slot 1, Destination slot 0 (move all outputs of MFP to BIU input tables). All submoves are set to default to No (Hold Last State).

- Submove 1:** (Moves discrete inputs)
Source reference Q00001
Destination reference Q00001
Length 7 bytes

Group Move No 8: Source slot 0, Destination slot 1 (move all inputs from station in BIU tables to MFP input table).

- Submove 1:** Source reference I00001
Destination reference I00001
Length 21 bytes
- Submove 2:** Source reference AI00001
Destination reference AI00001
Length 56 bytes

Example 5: Group Move

An Alspa CE80–20 Station has an N80 BIU in slot 0, a Micro Field Processor in slot 1 and a Smart analog input module in slot 2. See appendix D for additional examples.

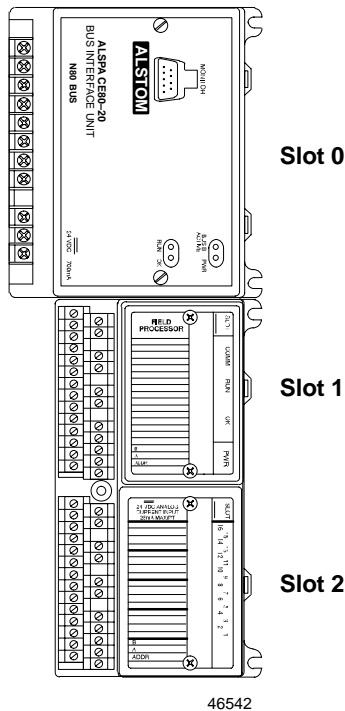

In this example, two group moves are used to transfer the following data:

- **Group 1: from the Smart Analog Input Module to the Micro Field Processor:**

The second byte of I data (which contains diagnostic status information about the module) is to be moved to MFP memory starting at I0017.

Also, the second channel of analog input (AI) data is to be moved to MFP memory starting at AI002.

The data group will be moved on BIU sweeps 1 and 9 (out of 1 to 16).

The group move would be:

Source: Slot 2 (the analog input module)
Destination: Slot 1 (the Micro Field Processor)
Move 1, Source Location: I009 (start of second byte)
Move 1, Destination Location: I0017
Move 1, Data Length: 1 (byte)
Move 2, Source Location: AI002 (start of second input)
Move 2, Destination Location: AI002
Move 2, Data Length: 2 (bytes)
Sweep Selections: 1 and 9 onl

- **Group 2: from the Micro Field Processor to the Smart Analog Input Module:**

Data from MFP memory starting at Q0017 is to be moved to the module's Q memory (used to clear module faults).

The data group will be moved on BIU sweeps 4 and 12.

The group move would be:

Source: Slot 1 (the Micro Field Processor)
Destination: Slot 2 (the analog input module)
Move 1, Source Location: Q0017
Move 1, Destination Location: Q0001
Move 1, Data Length: 2 (bytes)
Sweep Selections: 4 and 12 only